



Technical Sales Guide

GMV6 HR DC INVERTER VRF UNITS

(GC202007-I)

TECHNICAL SALES GUIDE-50/60Hz

CAPACITY RANGE: 22.4~246.0kW

SUPER HIGH AMBIENT OPERATION TO 55°C



CONTENTS



1 UNIT CHARACTERISTICS	1
2 UNIT PARAMETERS	9
3 ELECTRICAL SPECIFICATIONS.....	17
4 PRODUCT MODEL SELECTION AND COLLOCATION.....	20
5 PRODUCT CAPACITY RECTIFICATION.....	26
6 UNIT NOISE CURVES	106
7 UNIT GRAVITY CENTER DIAGRAMS	108
8 PRODUCT SIZE AND INSTALLATION	110
9 PIPING MODEL SELECTION.....	124
10 COMMUNICATION SYSTEM INTRODUCTION.....	134
11 EXTERNAL ELECTRICAL WIRING DIAGRAM.....	142
12 CALCULATION METHOD ON ADDING QUANTITY OF PIPING REFRIGERANT.....	144
13 NOTICES.....	145
14 OPTIONAL COMPONENTS.....	146

1 UNIT CHARACTERISTICS

1.1 Product chart

1.1.1 Outdoor unit chart



GMV6 HR VRF system: basic models of the full series are 8HP, 10HP, 12HP, 14HP, 16HP, 18HP, 20HP and 22HP, the combination model 24HP-88HP.

HP	Model	Combination Mode	Appearance
8	GMV-VQ224WM/C-X	/	
10	GMV-VQ280WM/C-X	/	
12	GMV-VQ335WM/C-X	/	
14	GMV-VQ400WM/C-X	/	
16	GMV-VQ450WM/C-X	/	
18	GMV-VQ504WM/C-X	/	
20	GMV-VQ560WM/C-X	/	
22	GMV-VQ615WM/C-X	/	
24	GMV-VQ680WM/C-X	280+400	
26	GMV-VQ730WM/C-X	280+450	
28	GMV-VQ784WM/C-X	280+504	
30	GMV-VQ840WM/C-X	280+560	
32	GMV-VQ895WM/C-X	280+615	
34	GMV-VQ950WM/C-X	335+615	
36	GMV-VQ1015WM/C-X	400+615	
38	GMV-VQ1065WM/C-X	450+615	
40	GMV-VQ1119WM/C-X	504+615	
42	GMV-VQ1175WM/C-X	560+615	
44	GMV-VQ1230WM/C-X	615+615	

HP	Model	Combination Mode	Appearance
46	GMV-VQ1290WM/C-X	280+450+560	
48	GMV-VQ1345WM/C-X	280+450+615	
50	GMV-VQ1400WM/C-X	335+450+615	
52	GMV-VQ1455WM/C-X	280+560+615	
54	GMV-VQ1510WM/C-X	280+615+615	
56	GMV-VQ1565WM/C-X	335+615+615	
58	GMV-VQ1630WM/C-X	400+615+615	
60	GMV-VQ1680WM/C-X	450+615+615	
62	GMV-VQ1734WM/C-X	504+615+615	
64	GMV-VQ1790WM/C-X	560+615+615	
66	GMV-VQ1845WM/C-X	615+615+615	
68	GMV-VQ1905WM/C-X	280+450+560+615	
70	GMV-VQ1959WM/C-X	280+504+560+615	
72	GMV-VQ2015WM/C-X	280+560+560+615	
74	GMV-VQ2070WM/C-X	280+560+615+615	
76	GMV-VQ2125WM/C-X	280+615+615+615	
78	GMV-VQ2180WM/C-X	335+615+615+615	
80	GMV-VQ2245WM/C-X	400+615+615+615	
82	GMV-VQ2295WM/C-X	450+615+615+615	
84	GMV-VQ2349WM/C-X	504+615+615+615	
86	GMV-VQ2405WM/C-X	560+615+615+615	
88	GMV-VQ2460WM/C-X	615+615+615+615	

1.1.2 Mode exchange box chart

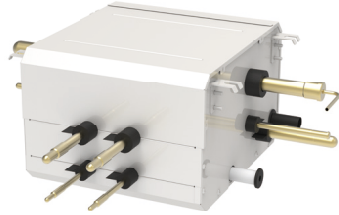
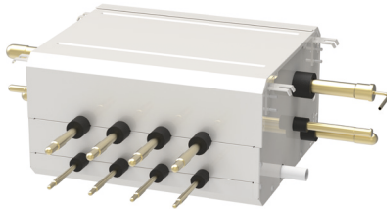
Model	Appearance
NCHS1D	

Model	Appearance
NCHS2D	
NCHS4D	
NCHS8D	

1.1.3 Hydro box chart

Model	Appearance
NRQR16L/A-T	
NRQR30L/A-T	

1.1.4 Water tank

Model	Appearance
SXTVD300LCJ2/A-K	

Note: water tank from Gree or local market is acceptable, only required inner coil water tank.

1.2 Product Functions

GMV6HR DC inverter multi VRF system adopts the advanced technologies such as efficient low-temperature enthalpy-adding system, partition heat exchange flow path, subcooling design, integrated aluminium electronic control, reliable operation control under ultra low temperature and so on, so the unit can operate smoothly between $-25^{\circ}\text{C}\sim 55^{\circ}\text{C}$. It provides comfortable environment for the user no matter in severe cold or intense heat. The capacity range of GMV6HR is 22.4kW~246kW, from 8HP~88HP, 41 models in total. Wide capacity range and flexible combination. It can be applied to the commercial occasions like large office building, production factory or arge malls.

Compared with GMV5HR, GMV6HR series can not only realize low temperature heating function, operation range under low and high temperature is wider, but also has all the functions of GMV5HR.

Energy-efficient

Thanks to the advanced full DC inverter technology, optimized AC system design and precise intelligent control technology.

➤ Efficient DC inverter low temperature enthalpy-adding scroll compressor

The compressor adopts the high pressure chamber of excellent performance. It inhales directly and reduce the overheat loss to improve compression efficiency.

Adopting the high-efficiency permanent synchronous motor, its rotor is permanent magnet, the stator is intertwined centrally and the efficiency is higher than the normal DC inverter compressor.

➤ Sensorless DC inverter fan motor

The DC inverter motor adopts the electromotive force to realize electrodeless speed regulation between 8Hz-85Hz. Compared with normal DC inverter motor, its operation current is smaller, input motor power is lower and efficiency is greatly enhanced.

➤ Leading torque control technology

It processes minimum current and maximum torque control technology

Utilize DC inverter compressor rotor magnetic resistance torque effectively, allowing the minimum current to output the maximum torque, reducing motor winding loss and realizing higher efficiency.

Directly control the motor torque to realize ultra low speed operation of DC inverter fan motor, torque pulsation is small, satisfying system demand while achieving comfort of higher requirement.

Quiet

Gree DC inverter multi VRF system fully considers comfort requirement, the humanized technology upgrade the comfort perfectly. The wider operation range of the unit ensures normal operation under severe cold or intense heat; quiet effect is better, creating a quiet working and living environment.

➤ Quiet mode of ODU

◆ Quiet at night

The system will memorize and judge the highest outdoor temperature. When the system is operating at night in low load, it will enter quiet mode automatically. Based on actual application occasion, 13 kinds of quiet mode can be set.

For example, it will enter night operation mode automatically after operating for 8h, then it enters normal mode after 9h.

◆ Compulsory quiet

When the unit is installed in the locations with lower noise requirement, quiet operation is necessary no matter in the daytime or evening, at this time, you can have three kinds of compulsory quiet mode setting to ensure that the unit is operated under low noise mode at any time. The lowest noise value is as low as 40dB(A).

◆ Intelligent silence

The unit can self-learn and customize user habits, and at the same time remember the user habits characteristics. According to the user's usage characteristics and actual load matching, the output capacity of the system can be determined automatically in the next 24 hours to achieve automatic silent operation.

➤ Quiet mode of IDU

IDU also adopts DC inverter motor to realize the electrodeless adjustment of speed regulation, reduce noise value greatly, sets auto quiet mode for IDU through wired controller. Start auto quiet function according to indoor temperature and people activity, the noise is as low as 22dB(A).

Leading technology ensures stable reliability

Gree DC inverter multi VRF system is famous in the industry with the advanced technology. After ten years of research and experiment, the technology of DC inverter multi system is more mature. From electrical component to mechanical assembly and control technology to communication technology, Gree DC inverter multi VRF has been upgraded comprehensively. The continued technology innovation will surely bring more reliable and efficient services for the user.

➤ Oil return control technology

Gree has two exclusive oil return control technologies.

◆ New generation of oil return control

Gree new generation of oil return control technology has implanted pressure control oil return technology, through pressure control, it controls system oil return and oil storage status of each compressor effectively, thus improving the service life of compressor greatly.

◆ Exclusive oil storage technology of compressor

Gree DC inverter unit has exclusive compressor oil storage technology and it controls the minimum oil level required when operating the compressor by judging the parameter.

➤ Refrigerant storage and distribution technology

Adopt non-accumulator system circuit, reduce refrigerant charge drastically and improve system refrigerant control precision, then store the surplus refrigerant in the pipe.

➤ Balancing oil control technology

◆ Balancing oil technology among modules

Change the defect of traditional timer oil return; it's needless to turn off the unit to balance the oil, judge the operation status of each module and compressor, calculate the oil reserve capacity of compressor, adjust the operation status of compressor to realize oil balance among modules. The non-balancing oil pipe design ensures the reliability and will not affect the capacity output of the system to maintain AC comfort.

◆ Oil balance technology among compressor

The refrigerant has a suction pipe in the compression working chamber of the compressor, and is compressed and discharged into the cavity of the totally enclosed compressor, and then flows through the refrigeration system through the exhaust pipe. According to the principle of motion fluid mechanics and the actual amount of oil required in the working process of the compressor, the height of the oil balance pipe is determined, the oil level of the oil pool is controlled; the minimum oil quantity required for each compressor during operation is ensured to realize the oil balance among the compressors.

➤ Cooling adopts the subcooling control technology to reduce cooling capacity substantially

New generation of efficient plate subcooler and condensate depression control method is adopted, the maximum condensate depression is 35°C, AC effect is more obvious.

➤ Unique comfort control

ODU adopts dual electronic expansion valve for adjustment, the grade of main electronic expansion valve is 3,000 and the subcooling electronic expansion valve is 480, precisely controlling the flow of modules in IDU and ODU.

Considering the installation characteristic (IDU type, pipe length, fall etc.), actual startup rate of IDU, ambient indoor and outdoor temperature, diversified system startup is realized under different ambient temperature and installation condition, the fastest startup is completed in 75s.

Humanized operation

➤ Auto address allocation and non-polarity communication

➤ Auto debugging and error detection

- Five kinds of auto debugging function
- ◆ Auto allocation of IDU and ODU address
- ◆ Auto detection of IDU and ODU quantity
- ◆ Auto detection of internal error of the unit
- ◆ Start operation debugging automatically
- ◆ Real-time judgment of pipeline abnormality
- The unit has three emergency functions of module, compressor and fan
- The unit has two methods of recycling refrigerant

Intelligent management

- Dual energy saving operation mode;

With the deepening of energy conservation and emission reduction and the stricter national requirements to urban electricity consumption, especially in summer, the peak season of electricity consumption, many cities will introduce corresponding power-limiting measures. Gree DC inverter multi VRF system has two energy-saving modes for users to choose freely to meet the requirement on peak power consumption and power-limiting.

- ◆ Capacity first: If there is sufficient power supply, priority is given to meeting the capacity needs. This mode is default factory setting.
- ◆ Auto energy-saving: System will automatically adjust parameters and balance the capacity and energy consumption according to the running state.
- ◆ Forcible energy-saving: Capacity output of ODU is limited. Depending on power consumption and user needs, a 90% or 80% capacity ratio can be selected.

- Energy consumption analysis and solution
- Emergency stop

Long distance monitoring is needless, ODU will introduce the fire alarm linkage signal directly, under emergency situation, it will stop the unit for operation immediately to avoid bigger losses.

- Partition management

Super-long piping distance design, the maximum length of total pipe is 1,000m

Compared with traditional screw chiller, the advantage of DC inverter multi VRF system is the easy and convenient piping. Gree DC inverter multi VRF system is more outstanding in the aspect of actual piping, enabling the AC system to be applied to all kinds of architecture, reducing installation cost of the user.

Cooling only system, the maximum attachable quantity of IDU is 80 sets

The attachable quantity of single system of most of the multi VRF systems in current market is 64 sets, while Gree DC inverter multi VRF system is integrated with several modular unit and can connect 80 sets of IDUs at the most, which is more applicable for large commercial office buildings, apartment or hotels.

Wide operation range

Operation range of temperature: cooling -10~55°C and heating -25~24°C.

New modular load allocation control

Choose unit module according to the operation status to realize efficient operation among modular unit, reduce energy consumption loss and improve energy efficiency of operation, which will enhance the reliability of the unit.

ODU high static pressure design with flexible choice

ODU will choose the corresponding static pressure according to architectural form, the maximum can be 110Pa, especially for the occasions which need to place the ODU inside the house.

1.3 Nomenclature

1.3.1 Outdoor unit

GMV	□	-	V	Q	□	W	□	/	□	□	-	□
1	2		3	4	5	6	7		8	9		10

No.	Description	Options
1	Product code	GMV—Gree Multi VRF Units
2	Suitable climate	Blank—T1 condition; T2—Low temperature climate; T3—High temperature climate
3	Special function	V—Low-temperature heat pump
4	Function code	Q—Heat recovery model
5	Code of cooling capacity	Nominal capacity/100(W)
6	Code for outdoor unit	W—Outdoor unit
7	Unit structure	M—Modular (top discharge); L—Non-modular (side discharge); Default—Non-modular (top discharge)
8	Refrigerant	R410A (omit)
9	Design No.	Named in order of A, B, C, or combined with 1, 2, 3...
10	Form of power source	X—380~415V-3Ph-50/60Hz

1.3.2 Mode exchange box

NCHS	□	□	□
1	2	3	4

No.	Description	Options
1	Product code	NCHS-Mode exchange box
2	Branch code	Quantity of branches
3	Design No.	Arrange by A, B, C...
4	Area code	(U)-North America omit-Other areas

1.3.3 Hydro box

NRQR	□	□	/	A	-	□
1	2	3		4		5

No.	Description	Optional Items
1	Model	NRQR-Hydro box
2	Rated capacity	Rated power of generator (kW)
3	Code of structure	G-Wall-mounted; L-Vertical; W-Horizontal
4	Design No.	Arrange in A, B, C... order
5	Form of power source	S-220-240V~, 50Hz/60Hz; T-Applicable to 208-230V~, 60Hz, and 220-240V~, 50Hz;

1.3.4 Water tank

SX	□	□	□	□	□	□	□	□	/	□	□	□
1	2	3	4	5	6	7	8	9		10		11

No.	Description	Optional Items
1	Model	SX-Water tank
2	Type of water tank	V-Heat pump water tank for multi VRF unit; Common heat pump water tank-Obmitted
3	Functional code	Obmitted-No electric heating; D-With electric heating function
4	Capacity of water tank	Unit-L
5	Form of structure	B-Wall-mounted; L-Floor standing
6	With bearing pressure or not	C-With bearing pressure; Omitted-No bearing pressure
7	Form of coil	Omitted-No heat exchange tube; J-Static heating mode of built-in coil (J represents single coil, J2 represents double coils); JW-Static heating mode of external winding coil; D-Coil with floor heating (D represents single coil, D2 represents double coils)
8	Structure of appearance	Omitted-Round; F-Square; T-Rectangle ; Y-Abnormity
9	Quantity of inner pot	Omitted-One; 2-Two
10	Design No.	Arrange in A, B, C... order
11	Form of power source	K-220-240V~ 50Hz

1.4 The range of production working temperature

—	Cooling	Heating	Water heating	Floor heating
Ambient temperature	-10°C ~55°C DB	-25°C ~24°C DB	-20°C ~35°C DB	-20°C ~24°C DB
Indoor temperature	14°C ~25°C WB	15°C ~27°C DB	—	15°C ~27°C DB
Indoor humidity	≤80%		—	—

When the indoor units are all VRF fresh air processor, the unit operating range is as follows:

—	Ambient temperature:
Cooling	16°C ~45°C
Heating	-7°C ~16°C

NOTE:

If exceeding the temperature range for working, the product may be damaged, which is not within the warranty range.

2 UNIT PARAMETERS

2.1 Performance parameter of outdoor unit

Model(integrated unit)			—	—	—	—
Model(single unit)			GMV-VQ224WM/C-X	GMV-VQ280WM/C-X	GMV-VQ335WM/C-X	GMV-VQ400WM/C-X
Cooling capacity	Rated	kW	22.4	28	33.5	40
	Heating capacity	Rated	kW	16.2	16.2	18.5
SEER	Max.	kW	25	31.5	37.5	45
	ducted	-	7.76	7.16	6.64	6.90
SCOP	cassette	-	7.24	6.37	6.67	5.93
	ducted	-	4.80	4.80	4.92	4.71
Sound pressure level(Cooling)	cassette	-	4.41	4.41	4.69	4.31
	Sound power level(Cooling)	dB(A)	60	61	63	63
Outdoor static pressure	ducted	dB(A)	80	83	83	91
	cassette	dB(A)	80	85	86	87
Compressor quantity	Pa		0-110	0-110	0-110	0-110
Refrigeration oil No. of compressor	set		1	1	1	1
Refrigeration oil charge	-		FV68H	FV68H	FV68H	FV68H
	Gross	L	4.6	4.6	4.6	6.1
	Compressor charge	L	1.1	1.1	1.1	1.1
Power Supply	The others	L	3.5	3.5	3.5	5
			380-415V 3N ~ 50Hz/60Hz	380-415V 3N ~ 50Hz/60Hz	380-415V 3N ~ 50Hz/60Hz	380-415V 3N ~ 50Hz/60Hz
Size(W×D×H)	mm		930×775×1690	930×775×1690	930×775×1690	1340×775×1690
Waterproof level			IPX4	IPX4	IPX4	IPX4
Connection pipe	High pressure gas pipe	mm	Φ15.9	Φ19.05	Φ19.05	Φ22.2
	Low pressure gas pipe	mm	Φ19.05	Φ22.2	Φ25.4	Φ25.4
	Liquid pipe	mm	Φ9.52	Φ9.52	Φ12.7	Φ12.7
	Connection method		Welding connection	Welding connection	Welding connection	Welding connection
Net weight	kg		243	243	256	325
Rated power input	kW		12.87	13.15	13.5	21
Rated current	A		23	23.5	24.1	37.5
Max. fuse current	A		25	25	25	40

Model(integrated unit)			—	—	—	—	
Model(single unit)			GMV-VQ450WM/C-X	GMV-VQ504WM/C-X	GMV-VQ560WM/C-X	GMV-VQ615WM/C-X	
Cooling capacity	Rated	kW	45	50.4	56	61.5	
	Heating capacity	Rated	kW	23.5	31	31	33
SEER	Max.	kW	50	56.5	63	69	
	ducted	-	6.36	6.87	6.45	5.88	
SCOP	cassette	-	5.71	6.72	6.26	5.25	
	ducted	-	4.71	4.31	4.31	4.38	
Sound power level(Cooling)	cassette	-	4.31	4.20	4.20	3.59	
	Sound pressure level(Cooling)		dB(A)	63	63	63	64
Outdoor static pressure	ducted	dB(A)	91	89	89	89	
	cassette	dB(A)	94	87	89	94	
Compressor quantity		Pa	0-110	0-110	0-110	0-110	
Refrigeration oil No. of compressor		set	1	2	2	2	
Refrigeration oil charge	Refrigeration oil No. of compressor		-	FV68H	FV68H	FV68H	FV68H
	Gross	L	6.1	7.2	7.2	7.2	
	Compressor charge	L	1.1	2.2	2.2	2.2	
The others		L	5	5	5	5	
Power Supply			380-415V 3N ~ 50Hz/60Hz	380-415V 3N ~ 50Hz/60Hz	380-415V 3N ~ 50Hz/60Hz	380-415V 3N ~ 50Hz/60Hz	
Size(W×D×H)		mm	1340×775×1690	1340×775×1690	1340×775×1690	1340×775×1690	
Waterproof level			IPX4	IPX4	IPX4	IPX4	
Connection pipe	High pressure gas pipe	mm	Φ22.2	Φ25.4	Φ25.4	Φ25.4	
	Low pressure gas pipe	mm	Φ28.6	Φ28.6	Φ28.6	Φ28.6	
	Liquid pipe	mm	Φ12.7	Φ15.9	Φ15.9	Φ15.9	
	Connection method			Welding connection	Welding connection	Welding connection	Welding connection
Net weight		kg	325	385	385	385	
Rated power input		kW	22	26.3	26.85	27.41	
Rated current		A	39.3	47	48	49	
Max. fuse current		A	40	50	50	50	

GMV6 HR DC Inverter VRF Units Technical Sales Guide

Model (integrated unit)			GMV-VQ680WM/C-X	GMV-VQ730WM/C-X	GMV-VQ784WM/C-X	GMV-VQ840WM/C-X
Model (single unit)			GMV-VQ280WM/C-X+ GMV-VQ400WM/C-X	GMV-VQ280WM/C-X+ GMV-VQ450WM/C-X	GMV-VQ280WM/C-X+ GMV-VQ504WM/C-X	GMV-VQ280WM/C-X+ GMV-VQ560WM/C-X
Cooling capacity	Rated	kW	68	73	78.4	84
	Heating capacity	Rated	39.7	39.7	47.2	47.2
Heating capacity	Max.	kW	76.5	81.5	88	94.5
	Outdoor static pressure	Pa	0-110	0-110	0-110	0-110
Power Supply			380-415V 3N ~ 50Hz/60Hz	380-415V 3N ~ 50Hz/60Hz	380-415V 3N ~ 50Hz/60Hz	380-415V 3N ~ 50Hz/60Hz
Size(W×D×H)		mm	930×775×1690+ 1340×775×1690	930×775×1690+ 1340×775×1690	930×775×1690+ 1340×775×1690	930×775×1690+ 1340×775×1690
Waterproof level			IPX4	IPX4	IPX4	IPX4
Connection pipe	High pressure gas pipe	mm	Φ25.4	Φ28.6	Φ28.6	Φ28.6
	Low pressure gas pipe	mm	Φ28.6	Φ31.8	Φ31.8	Φ31.8
	Liquid pipe	mm	Φ15.9	Φ19.05	Φ19.05	Φ19.05
	Connection method			Welding connection	Welding connection	Welding connection
Net weight		kg	243+325	243+325	243+385	243+385
Rated power input		kW	13.15+21.00	13.15+22.00	13.15+26.3	13.15+26.85
Rated current		A	23.5+37.5	23.5+39.3	23.5+47	23.5+48
Max. fuse current		A	25+40	25+40	25+50	25+50

Model (integrated unit)			GMV-VQ895WM/C-X	GMV-VQ950WM/C-X	GMV-VQ1015WM/C-X	GMV-VQ1065WM/C-X
Model (single unit)			GMV-VQ280WM/C-X+ GMV-VQ615WM/C-X	GMV-VQ335WM/C-X+ GMV-VQ615WM/C-X	GMV-VQ400WM/C-X+ GMV-VQ615WM/C-X	GMV-VQ450WM/C-X+ GMV-VQ615WM/C-X
Cooling capacity	Rated	kW	89.5	95	101.5	106.5
	Heating capacity	Rated	49.2	51.5	56.50	56.50
Heating capacity	Max.	kW	100.5	106.5	114	119
	Outdoor static pressure	Pa	0-110	0-110	0-110	0-110
Power Supply			380-415V 3N ~ 50Hz/60Hz	380-415V 3N ~ 50Hz/60Hz	380-415V 3N ~ 50Hz/60Hz	380-415V 3N ~ 50Hz/60Hz
Size(W×D×H)		mm	930×775×1690+ 1340×775×1690	930×775×1690+ 1340×775×1690	1340×775×1690+ 1340×775×1690	1340×775×1690+ 1340×775×1690
Waterproof level			IPX4	IPX4	IPX4	IPX4
Connection pipe	High pressure gas pipe	mm	Φ28.6	Φ28.6	Φ31.8	Φ31.8
	Low pressure gas pipe	mm	Φ31.8	Φ31.8	Φ38.1	Φ38.1
	Liquid pipe	mm	Φ19.05	Φ19.05	Φ19.05	Φ19.05
	Connection method			Welding connection	Welding connection	Welding connection
Net weight		kg	243+385	256+385	325+385	325+385
Rated power input		kW	13.15+27.41	13.5+27.41	21+27.41	22+27.41
Rated current		A	23.5+49	24.1+49	37.5+49	39.3+49
Max. fuse current		A	25+50	25+50	40+50	40+50

Model (integrated unit)			GMV-VQ1119WM/C-X	GMV-VQ1175WM/C-X	GMV-VQ1230WM/C-X	GMV-VQ1290WM/C-X
Model (single unit)			GMV-VQ504WM/C-X+ GMV-VQ615WM/C-X	GMV-VQ560WM/C-X+ GMV-VQ615WM/C-X	GMV-VQ615WM/C-X+ GMV-VQ615WM/C-X	GMV-VQ280WM/C-X+ GMV-VQ450WM/C-X+ GMV-VQ560WM/C-X
Cooling capacity	Rated	kW	111.9	117.5	123	129
	Heating capacity	Rated	kW	64	64	66
Heating capacity	Max.	kW	125.5	132	138	144.5
	Outdoor static pressure	Pa	0-110	0-110	0-110	0-110
Power Supply			380-415V 3N ~ 50Hz/60Hz	380-415V 3N ~ 50Hz/60Hz	380-415V 3N ~ 50Hz/60Hz	380-415V 3N ~ 50Hz/60Hz
Size(W×D×H)		mm	1340×775×1690+ 1340×775×1690	1340×775×1690+ 1340×775×1690	1340×775×1690+ 1340×775×1690	930×775×1690+1340 ×775×1690+1340×7 75×1690
Waterproof level			IPX4	IPX4	IPX4	IPX4
Connection pipe	High pressure gas pipe	mm	Φ31.8	Φ31.8	Φ31.8	Φ31.8
	Low pressure gas pipe	mm	Φ38.1	Φ38.1	Φ38.1	Φ38.1
	Liquid pipe	mm	Φ19.05	Φ19.05	Φ19.05	Φ19.05
	Connection method			Welding connection	Welding connection	Welding connection
Net weight		kg	385+385	385+385	385+385	243+325+385
Rated power input		kW	26.3+27.41	26.85+27.41	27.41+27.41	13.15+22.00+26.85
Rated current		A	47+49	48+49	49+49	23.5+39.3+48
Max. fuse current		A	50+50	50+50	50+50	25+40+50

Model (integrated unit)			GMV-VQ1345WM/C-X	GMV-VQ1400WM/C-X	GMV-VQ1455WM/C-X	GMV-VQ1510WM/C-X
Model (single unit)			GMV-VQ280WM/C-X+ GMV-VQ450WM/C-X+ GMV-VQ615WM/C-X	GMV-VQ335WM/C-X+ GMV-VQ450WM/C-X+ GMV-VQ615WM/C-X	GMV-VQ280WM/C-X+ GMV-VQ560WM/C-X+ GMV-VQ615WM/C-X	GMV-VQ280WM/C-X+ GMV-VQ615WM/C-X+ GMV-VQ615WM/C-X
Cooling capacity	Rated	kW	134.5	140	145.5	151
	Heating capacity	Rated	kW	72.70	74.82	80.2
Heating capacity	Max.	kW	150.5	156.5	163.5	169.5
	Outdoor static pressure	Pa	0-110	0-110	0-110	0-110
Power Supply			380-415V 3N ~ 50Hz/60Hz	380-415V 3N ~ 50Hz/60Hz	380-415V 3N ~ 50Hz/60Hz	380-415V 3N ~ 50Hz/60Hz
Size(W×D×H)		mm	930×775×1690+1340 ×775×1690+1340×7 75×1690	930×775×1690+1340 ×775×1690+1340×7 75×1690	930×775×1690+1340 ×775×1690+1340×7 75×1690	930×775×1690+1340 ×775×1690+1340×7 75×1690
Waterproof level			IPX4	IPX4	IPX4	IPX4
Connection pipe	High pressure gas pipe	mm	Φ31.8	Φ38.1	Φ38.1	Φ38.1
	Low pressure gas pipe	mm	Φ38.1	Φ41.3	Φ41.3	Φ41.3
	Liquid pipe	mm	Φ19.05	Φ19.05	Φ19.05	Φ19.05
	Connection method			Welding connection	Welding connection	Welding connection
Net weight		kg	243+325+385	256+325+385	243+385+385	243+385+385
Rated power input		kW	13.15+22.00+27.41	13.5+22.00+27.41	13.15+26.85+27.41	13.15+27.41+27.41
Rated current		A	23.5+39.3+49	24.1+39.3+49	23.5+48+49	23.5+49+49
Max. fuse current		A	25+40+50	25+40+50	25+50+50	25+50+50

GMV6 HR DC Inverter VRF Units Technical Sales Guide

Model (integrated unit)			GMV-VQ1565WM/C-X	GMV-VQ1630WM/C-X	GMV-VQ1680WM/C-X	GMV-VQ1734WM/C-X
Model (single unit)			GMV-VQ335WM/C-X+ GMV-VQ615WM/C-X+ GMV-VQ615WM/C-X	GMV-VQ400WM/C-X+ GMV-VQ615WM/C-X+ GMV-VQ615WM/C-X	GMV-VQ450WM/C-X+ GMV-VQ615WM/C-X+ GMV-VQ615WM/C-X	GMV-VQ504WM/C-X+ GMV-VQ615WM/C-X+ GMV-VQ615WM/C-X
Cooling capacity	Rated	kW	156.5	163	168	173.4
	Heating capacity	Rated	kW	84.5	89.50	89.50
Heating capacity	Max.	kW	175.5	183	188	194.5
	Outdoor static pressure	Pa	0-110	0-110	0-110	0-110
Power Supply			380-415V 3N ~ 50Hz/60Hz	380-415V 3N ~ 50Hz/60Hz	380-415V 3N ~ 50Hz/60Hz	380-415V 3N ~ 50Hz/60Hz
Size(W×D×H)		mm	930×775×1690+1340 ×775×1690+1340×7 75×1690	1340×775×1690+134 0×775×1690+1340× 775×1690	1340×775×1690+134 0×775×1690+1340× 775×1690	1340×775×1690+134 0×775×1690+1340× 775×1690
Waterproof level			IPX4	IPX4	IPX4	IPX4
Connection pipe	High pressure gas pipe	mm	Φ38.1	Φ38.1	Φ38.1	Φ38.1
	Low pressure gas pipe	mm	Φ41.3	Φ41.3	Φ41.3	Φ41.3
	Liquid pipe	mm	Φ19.05	Φ19.05	Φ19.05	Φ19.05
	Connection method		Welding connection	Welding connection	Welding connection	Welding connection
Net weight		kg	256+385+385	325+385+385	325+385+385	385+385+385
Rated power input		kW	13.5+27.41+27.41	21+27.41+27.41	22+27.41+27.41	26.3+27.41+27.41
Rated current		A	24.1+49+49	37.5+49+49	39.3+49+49	47+49+49
Max. fuse current		A	25+50+50	40+50+50	40+50+50	50+50+50

Model (integrated unit)			GMV-VQ1790WM/C-X	GMV-VQ1845WM/C-X	GMV-VQ1905WM/C-X	GMV-VQ1959WM/C-X
Model (single unit)			GMV-VQ560WM/C-X+ GMV-VQ615WM/C-X+ GMV-VQ615WM/C-X	GMV-VQ615WM/C-X+ GMV-VQ615WM/C-X+ GMV-VQ615WM/C-X	GMV-VQ280WM/C-X+ GMV-VQ450WM/C-X+ GMV-VQ560WM/C-X+ GMV-VQ615WM/C-X	GMV-VQ280WM/C-X+ GMV-VQ504WM/C-X+ GMV-VQ560WM/C-X+ GMV-VQ615WM/C-X
Cooling capacity	Rated	kW	179	184.5	190.5	195.9
	Heating capacity	Rated	kW	97	99	103.70
Heating capacity	Max.	kW	201	207	213.5	220
	Outdoor static pressure	Pa	0-110	0-110	0-110	0-110
Power Supply			380-415V 3N ~ 50Hz/60Hz	380-415V 3N ~ 50Hz/60Hz	380-415V 3N ~ 50Hz/60Hz	380-415V 3N ~ 50Hz/60Hz
Size(W×D×H)		mm	1340×775×1690+134 0×775×1690+1340× 775×1690	1340×775×1690+134 0×775×1690+1340× 775×1690	930×775×1690+1340 ×775×1690+1340×7 75×1690	930×775×1690+1340 ×775×1690+1340×7 75×1690
Waterproof level			IPX4	IPX4	IPX4	IPX4
Connection pipe	High pressure gas pipe	mm	Φ38.1	Φ38.1	Φ41.3	Φ41.3
	Low pressure gas pipe	mm	Φ41.3	Φ41.3	Φ44.5	Φ44.5
	Liquid pipe	mm	Φ19.05	Φ19.05	Φ22.2	Φ22.2
	Connection method		Welding connection	Welding connection	Welding connection	Welding connection
Net weight		kg	385+385+385	385+385+385	243+325+385+385	243+385+385+385
Rated power input		kW	26.85+27.41+27.41	27.41+27.41+27.41	13.15+22.00+26.85+27.41	13.15+26.3+26.85+27.41
Rated current		A	48+49+49	49+49+49	23.5+39.3+48+49	23.5+47+48+49
Max. fuse current		A	50+50+50	50+50+50	25+40+50+50	25+50+50+50

Model (integrated unit)			GMV-VQ2015WM/C-X	GMV-VQ2070WM/C-X	GMV-VQ2125WM/C-X	GMV-VQ2180WM/C-X
Model (single unit)			GMV-VQ280WM/C-X+ GMV-VQ560WM/C-X+ GMV-VQ560WM/C-X+ GMV-VQ615WM/C-X	GMV-VQ280WM/C-X+ GMV-VQ560WM/C-X+ GMV-VQ615WM/C-X+ GMV-VQ615WM/C-X	GMV-VQ280WM/C-X+ GMV-VQ615WM/C-X+ GMV-VQ615WM/C-X+ GMV-VQ615WM/C-X	GMV-VQ335WM/C-X+ GMV-VQ615WM/C-X+ GMV-VQ615WM/C-X+ GMV-VQ615WM/C-X
Cooling capacity	Rated	kW	201.5	207	212.5	218
	Max.	kW	226.5	232.5	238.5	244.5
Heating capacity	Rated	kW	111.2	113.2	115.2	117.5
	Max.	kW	226.5	232.5	238.5	244.5
Outdoor static pressure		Pa	0-110	0-110	0-110	0-110
Power Supply			380-415V 3N ~ 50Hz/60Hz	380-415V 3N ~ 50Hz/60Hz	380-415V 3N ~ 50Hz/60Hz	380-415V 3N ~ 50Hz/60Hz
Size(W×D×H)		mm	930×775×1690+1340 ×775×1690+1340×7 75×1690+1340×775 ×1690	930×775×1690+1340 ×775×1690+1340×7 75×1690+1340×775 ×1690	930×775×1690+1340 ×775×1690+1340×7 75×1690+1340×775 ×1690	930×775×1690+1340 ×775×1690+1340×7 75×1690+1340×775 ×1690
Waterproof level			IPX4	IPX4	IPX4	IPX4
Connection pipe	High pressure gas pipe	mm	Φ41.3	Φ41.3	Φ41.3	Φ41.3
	Low pressure gas pipe	mm	Φ44.5	Φ44.5	Φ44.5	Φ44.5
	Liquid pipe	mm	Φ22.2	Φ22.2	Φ22.2	Φ22.2
	Connection method		Welding connection	Welding connection	Welding connection	Welding connection
Net weight		kg	243+385+385+385	243+385+385+385	243+385+385+385	256+385+385+385
Rated power input		kW	13.15+26.85+ 26.85+27.41	13.15+26.85+ 27.41+27.41	13.15+27.41+ 27.41+27.41	13.5+27.41+ 27.41+27.41
Rated current		A	23.5+48+48+49	23.5+48+49+49	23.5+49+49+49	24.1+49+49+49
Max. fuse current		A	25+50+50+50	25+50+50+50	25+50+50+50	25+50+50+50

Model (integrated unit)			GMV-VQ2245WM/C-X	GMV-VQ2295WM/C-X	GMV-VQ2349WM/C-X	GMV-VQ2405WM/C-X	GMV-VQ2460WM/C-X
Model (single unit)			GMV-VQ400WM/C-X+ GMV-VQ615WM/C-X+ GMV-VQ615WM/C-X+ GMV-VQ615WM/C-X	GMV-VQ450WM/C-X+ GMV-VQ615WM/C-X+ GMV-VQ615WM/C-X+ GMV-VQ615WM/C-X	GMV-VQ504WM/C-X+ GMV-VQ615WM/C-X+ GMV-VQ615WM/C-X+ GMV-VQ615WM/C-X	GMV-VQ560WM/C-X+ GMV-VQ615WM/C-X+ GMV-VQ615WM/C-X+ GMV-VQ615WM/C-X	GMV-VQ615WM/C-X+ GMV-VQ615WM/C-X+ GMV-VQ615WM/C-X+ GMV-VQ615WM/C-X
Cooling capacity	Rated	kW	224.5	229.5	234.9	240.5	246
	Max.	kW	252	257	263.5	270	276
Heating capacity	Rated	kW	122.50	122.50	130	130	132
	Max.	kW	252	257	263.5	270	276
Outdoor static pressure		Pa	0-110	0-110	0-110	0-110	0-110
Power Supply			380-415V 3N ~ 50Hz/60Hz	380-415V 3N ~ 50Hz/60Hz	380-415V 3N ~ 50Hz/60Hz	380-415V 3N ~ 50Hz/60Hz	380-415V 3N ~ 50Hz/60Hz
Size(W×D×H)		mm	1340×775×1690 +1340×775×169 0+1340×775×16 90+1340×775×1 690	1340×775×1690 +1340×775×169 0+1340×775×16 90+1340×775×1 690	1340×775×1690 +1340×775×169 0+1340×775×16 90+1340×775×1 690	1340×775×1690 +1340×775×169 0+1340×775×16 90+1340×775×1 690	1340×775×1690 +1340×775×169 0+1340×775×16 90+1340×775×1 690
Waterproof level			IPX4	IPX4	IPX4	IPX4	IPX4

Model (integrated unit)			GMV-VQ2245WM/C-X	GMV-VQ2295WM/C-X	GMV-VQ2349WM/C-X	GMV-VQ2405WM/C-X	GMV-VQ2460WM/C-X
Model (single unit)			GMV-VQ400WM/C-X+ GMV-VQ615WM/C-X+ GMV-VQ615WM/C-X+ GMV-VQ615WM/C-X	GMV-VQ450WM/C-X+ GMV-VQ615WM/C-X+ GMV-VQ615WM/C-X+ GMV-VQ615WM/C-X	GMV-VQ504WM/C-X+ GMV-VQ615WM/C-X+ GMV-VQ615WM/C-X+ GMV-VQ615WM/C-X	GMV-VQ560WM/C-X+ GMV-VQ615WM/C-X+ GMV-VQ615WM/C-X+ GMV-VQ615WM/C-X	GMV-VQ615WM/C-X+ GMV-VQ615WM/C-X+ GMV-VQ615WM/C-X+ GMV-VQ615WM/C-X
Connection pipe	High pressure gas pipe	mm	Φ41.3	Φ41.3	Φ41.3	Φ41.3	Φ41.3
	Low pressure gas pipe	mm	Φ44.5	Φ44.5	Φ44.5	Φ44.5	Φ44.5
	Liquid pipe	mm	Φ22.2	Φ22.2	Φ22.2	Φ22.2	Φ22.2
	Connection method			Welding connection	Welding connection	Welding connection	Welding connection
Net weight		kg	325+385+385+385	325+385+385+385	385+385+385+385	385+385+385+385	385+385+385+385
Rated power input		kW	21+27.41+27.41+27.41	22+27.41+27.41+27.41	26.3+27.41+27.41+27.41	26.85+27.41+27.41+27.41	27.41+27.41+27.41+27.41
Rated current		A	37.5+49+49+49	39.3+49+49+49	47+49+49+49	48+49+49+49	49+49+49+49
Max. fuse current		A	40+50+50+50	40+50+50+50	50+50+50+50	50+50+50+50	50+50+50+50

NOTES:

- Rated cooling capacity test conditions: indoor 27°C DB/19°C WB, outdoor 35°C DB; connection pipe length: 5 m, without height drop between units.
- Rated heating capacity test conditions(Tdesingnh): indoor 20°C DB, outdoor -10°C DB/-11 °C WB; connection pipe length: 5 m, without height drop between units. Max heating capacity test conditions: indoor 20°C DB, outdoor 7°C DB/6 °C WB; connection pipe length: 5 m, without height drop between units.
- The total capacity of connected indoor units must be in the range of 50%~135% of the outdoor unit capacity. The relevant parameters can be corrected by referring to the unit capacity correction table.
- The above parameters are tested based on the standard connection pipe length. In the actual project, the parameters should be corrected referring to the capacity correction for the long connection pipe of units.
- Specifications may be changed due to product improvement. Please refer to nameplates of the units.

2.2 Performance parameter of mode exchange box

Model			NCHS1D	NCHS2D	NCHS4D	NCHS8D	
Numbers of branches		unit	1	2	4	8	
Maximum numbers of connectable IDUs	Per branch	unit	8	8	8	8	
	Total	unit	8	16	32	64	
Maximum capacity of connectable IDUs	Per branch	kW	16	16	16	16	
	Total	kW	16	28	45	85	
Power supply			220-240V ~ 50/60Hz				
Piping connections	ODU	Liquid	mm	Φ9.52	Φ9.52	Φ12.7	Φ15.9
		High pressure gas	mm	Φ19.05	Φ19.05	Φ22.2	Φ22.2
		Low pressure gas	mm	Φ22.2	Φ22.2	Φ28.6	Φ28.6
	IDU	Liquid	mm	Φ6.35/9.52	Φ6.35/9.52	Φ6.35/9.52	Φ6.35/9.52
		Gas	mm	Φ12.7/15.9	Φ12.7/15.9	Φ12.7/15.9	Φ12.7/15.9
	Outline dimension(W×D×H)		mm	340×388×250	340×388×250	460×388×250	784×388×250

2.3 Performance parameter of hydro box

Model		NRQR16L/A-T	NRQR30L/A-T
Hot water heating capacity	kW	4.5(3.6~16)	4.5(3.6~30)
Max setting temperature of domestic hot water	°C	55(35~55)	55(35~55)
Floor heating capacity	kW	16	30
Max setting temperature of floor heating	°C	45(25~45)	45(25~45)
Power supply	-	220-240V~ 50Hz 208-230V~ 60Hz	220-240V~ 50Hz 208-230V~ 60Hz
Heat exchanger	Type	-	Plate heat exchanger
	Quantity	-	1
	Rated water flow	l/min	46
Water system connection	Diameter of inlet/outlet water pipe	mm	Φ25
	Thread specification	-	G1
Refrigerant system connection	Gas pipe	mm	Φ15.9
	Liquid pipe	mm	Φ9.52
Outline dimension(W×D×H)	mm	515×330×606	515×330×606
Net weight	kg	36	40

NOTES:

The parameters may change due to product improvement; please refer to the parameters on the nameplate.

2.4 Performance parameter of water tank

Model		SXTVD300LCJ2/A-K
Capacity	L	300
Electric heating power consumption	kW	3
Max. Allowable Pressure	MPa	0.7
Liner	Material	-
	Thickness	mm
Insulation	Material	-
	Thickness	mm
Outer layer	Material	-
	Thickness	mm
Circular Water Pipe	Diameter	mm
	Screw Thread Spec	-
Cold water inter pipe	Diameter	mm
	Screw Thread Spec	-
Hot water inter pipe	Diameter	mm
	Screw Thread Spec	-
Dimension of Outline	Outer Diameter × Height	mm
Net Weight	kg	135

3 ELECTRICAL SPECIFICATIONS

3.1 Electrical parameter of outdoor unit

Model	Combination method	Power supply	Capacity of circuit breaker of each combination module (A)	Minimum cross-sectional area of grounding wire (mm ²)	Recommended wire (cross-sectional area) (mm ²)
GMV-VQ224WM/C-X	-	380-415V 3N~50/60Hz	25	2.5	2.5×5
GMV-VQ280WM/C-X	-	380-415V 3N~50/60Hz	25	2.5	2.5×5
GMV-VQ335WM/C-X	-	380-415V 3N~50/60Hz	25	4.0	4.0×5
GMV-VQ400WM/C-X	-	380-415V 3N~50/60Hz	40	6.0	6.0×5
GMV-VQ450WM/C-X	-	380-415V 3N~50/60Hz	40	6.0	6.0×5
GMV-VQ504WM/C-X	-	380-415V 3N~50/60Hz	50	10.0	10.0×5
GMV-VQ560WM/C-X	-	380-415V 3N~50/60Hz	50	10.0	10.0×5
GMV-VQ615WM/C-X	-	380-415V 3N~50/60Hz	50	10.0	10.0×5
GMV-VQ680WM/C-X	280+400	380-415V 3N~50/60Hz	25+40	2.5+6.0	2.5×5+6.0×5
GMV-VQ730WM/C-X	280+450	380-415V 3N~50/60Hz	25+40	2.5+6.0	2.5×5+6.0×5
GMV-VQ784WM/C-X	280+504	380-415V 3N~50/60Hz	25+50	2.5+10.0	2.5×5+10.0×5
GMV-VQ840WM/C-X	280+560	380-415V 3N~50/60Hz	25+50	2.5+10.0	2.5×5+10.0×5
GMV-VQ895WM/C-X	280+615	380-415V 3N~50/60Hz	25+50	2.5+10.0	2.5×5+10.0×5
GMV-VQ950WM/C-X	335+615	380-415V 3N~50/60Hz	25+50	4.0+10.0	4.0×5+10.0×5
GMV-VQ1015WM/C-X	400+615	380-415V 3N~50/60Hz	40+50	6.0+10.0	6.0×5+10.0×5
GMV-VQ1065WM/C-X	450+615	380-415V 3N~50/60Hz	40+50	6.0+10.0	6.0×5+10.0×5
GMV-VQ1119WM/C-X	504+615	380-415V 3N~50/60Hz	50+50	10.0+10.0	10.0×5+10.0×5
GMV-VQ1175WM/C-X	560+615	380-415V 3N~50/60Hz	50+50	10.0+10.0	10.0×5+10.0×5
GMV-VQ1230WM/C-X	615+615	380-415V 3N~50/60Hz	50+50	10.0+10.0	10.0×5+10.0×5
GMV-VQ1290WM/C-X	280+450+560	380-415V 3N~50/60Hz	25+40+50	2.5+6.0+10.0	2.5×5+6.0×5+10.0×5
GMV-VQ1345WM/C-X	280+450+615	380-415V 3N~50/60Hz	25+40+50	2.5+6.0+10.0	2.5×5+6.0×5+10.0×5
GMV-VQ1400WM/C-X	335+450+615	380-415V 3N~50/60Hz	25+40+50	4.0+6.0+10.0	4.0×5+6.0×5+10.0×5
GMV-VQ1455WM/C-X	280+560+615	380-415V 3N~50/60Hz	25+50+50	2.5+10.0+10.0	2.5×5+10.0×5+10.0×5
GMV-VQ1510WM/C-X	280+615+615	380-415V 3N~50/60Hz	25+50+50	2.5+10.0+10.0	2.5×5+10.0×5+10.0×5
GMV-VQ1565WM/C-X	335+615+615	380-415V 3N~50/60Hz	25+50+50	4.0+10.0+10.0	4.0×5+10.0×5+10.0×5
GMV-VQ1630WM/C-X	400+615+615	380-415V 3N~50/60Hz	40+50+50	6.0+10.0+10.0	6.0×5+10.0×5+10.0×5
GMV-VQ1680WM/C-X	450+615+615	380-415V 3N~50/60Hz	40+50+50	6.0+10.0+10.0	6.0×5+10.0×5+10.0×5
GMV-VQ1734WM/C-X	504+615+615	380-415V 3N~50/60Hz	50+50+50	10.0+10.0+10.0	10.0×5+10.0×5+10.0×5
GMV-VQ1790WM/C-X	560+615+615	380-415V 3N~50/60Hz	50+50+50	10.0+10.0+10.0	10.0×5+10.0×5+10.0×5

Model	Combination method	Power supply	Capacity of circuit breaker of each combination module (A)	Minimum cross-sectional area of grounding wire (mm ²)	Recommended wire (cross-sectional area) (mm ²)
GMV-VQ1845WM/C-X	615+615+615	380-415V 3N~50/60Hz	50+50+50	10.0+10.0+10.0	10.0×5+10.0×5+10.0×5
GMV-VQ1905WM/C-X	280+450+560+615	380-415V 3N~50/60Hz	25+40+50+50	2.5+6.0+10.0+10.0	2.5×5+6.0×5+10.0×5+10.0×5
GMV-VQ1959WM/C-X	280+504+560+615	380-415V 3N~50/60Hz	25+50+50+50	2.5+10.0+10.0+10.0	2.5×5+10.0×5+10.0×5+10.0×5
GMV-VQ2015WM/C-X	280+560+560+615	380-415V 3N~50/60Hz	25+50+50+50	2.5+10.0+10.0+10.0	2.5×5+10.0×5+10.0×5+10.0×5
GMV-VQ2070WM/C-X	280+560+615+615	380-415V 3N~50/60Hz	25+50+50+50	2.5+10.0+10.0+10.0	2.5×5+10.0×5+10.0×5+10.0×5
GMV-VQ2125WM/C-X	280+615+615+615	380-415V 3N~50/60Hz	25+50+50+50	2.5+10.0+10.0+10.0	2.5×5+10.0×5+10.0×5+10.0×5
GMV-VQ2180WM/C-X	335+615+615+615	380-415V 3N~50/60Hz	25+50+50+50	4.0+10.0+10.0+10.0	4.0×5+10.0×5+10.0×5+10.0×5
GMV-VQ2245WM/C-X	400+615+615+615	380-415V 3N~50/60Hz	40+50+50+50	6.0+10.0+10.0+10.0	6.0×5+10.0×5+10.0×5+10.0×5
GMV-VQ2295WM/C-X	450+615+615+615	380-415V 3N~50/60Hz	40+50+50+50	6.0+10.0+10.0+10.0	6.0×5+10.0×5+10.0×5+10.0×5
GMV-VQ2349WM/C-X	504+615+615+615	380-415V 3N~50/60Hz	50+50+50+50	10.0+10.0+10.0+10.0	10.0×5+10.0×5+10.0×5+10.0×5
GMV-VQ2405WM/C-X	560+615+615+615	380-415V 3N~50/60Hz	50+50+50+50	10.0+10.0+10.0+10.0	10.0×5+10.0×5+10.0×5+10.0×5
GMV-VQ2460WM/C-X	615+615+615+615	380-415V 3N~50/60Hz	50+50+50+50	10.0+10.0+10.0+10.0	10.0×5+10.0×5+10.0×5+10.0×5

NOTES:

- a. Selection of circuit breaker and power cord is based upon unit's maximum power (maximum current).
- b. Specification of power cord is based on the working condition where ambient temperature is 40°C and multi-core copper cable with working temperature of 90°C is lying on the surface of slot. If working condition changes, please adjust the specification according to national standard.
- c. Copper-core cable which complies with local regulations must be applied.
- d. The engineering wiring should meet IEC 60364-5-52 regulations. Ensure that the circuit voltage drop meets the requirements and the voltage of the equipment is not lower than the lower declared limit of the equipment.
- e. Specification of circuit breaker is based on the working condition where ambient temperature of circuit breaker is 40 °C . If working condition changes, please adjust according to the circuit breaker specification.

3.2 Electrical parameter of mode exchange box

Model	Power	Capacity of air switch (A)	Min sectional area for earthing wire (mm ²)	Min sectional area for power cord(mm ²)
NCHS1D	220-240V~ 50/60Hz	6	1.0	1.0
NCHS2D	220-240V~ 50/60Hz	6	1.0	1.0
NCHS4D	220-240V~ 50/60Hz	6	1.0	1.0
NCHS8D	220-240V~ 50/60Hz	6	1.0	1.0

NOTES:

- a. Above circuit breaker and power cord specification are selected according to the max power (max current).
- b. Specification of power cord is based on the working condition where ambient temperature is 40°C and multi-core copper cable (working temperature is 90°C, e.g. power cable with YJV cross-linked

copper, insulated PE and PVC sheath) is lying on the surface of slot. If working condition changes, please adjust the specification according to national standard.

c. Specification of circuit breaker is based on the working condition where ambient temperature of circuit breaker is 40°C. If working condition changes, please adjust the specification according to national standard.

d. When installing the cut-off device next to the unit, the min space between every two levels of cut-off device should be 3mm (for indoor unit and outdoor unit).

3.3 Electrical parameter of hydro box

- (1) The hydro box belongs to Category I Electric Appliance. Therefore, be sure to take reliable earthed measures. The earthed wire shall be connected to the special earthed device on the construction. The installation must be done by specialist technicians.
- (2) The fixed circuit must be provided with leakage protection switch and air switch that have enough capacity.
- (3) The power supply must comply with the ratings on nameplate, while the special circuit for air conditioner must be used.
- (4) The diameter of power cables shall be big enough. Please select the power cables in reference to the specifications below.
- (5) Carry out installation according to national wiring rules.
- (6) Do not pull the power cables with force.

Model	Type of power supply	Min. sectional area of power cable			
		Live wire(mm ²)	Neutral wire(mm ²)	Earthed wire(mm ²)	Air switch capacity(A)
NRQR16L/A-T	220-240V~ 50Hz 208-230V~ 60Hz	1.5	1.5	1.5	6
NRQR30L/A-T	220-240V~ 50Hz 208-230V~ 60Hz	1.5	1.5	1.5	6

NOTES:

- a. The power cable must be copper-core cable, and its working temperature shall not be higher than the specified value.
- b. If the power cable is longer than 15m, please increase its sectional area appropriately, thus to avoid overloading.
- c. The power cable specification refers to the specification of BV single-cord cable (2~4 cords) laid when inserting the plastic pipe and selected the working environment temperature is 40°C. The air switch is used for a temperature of 40°C and it shall be "D" type.
- d. All electrical installation must be performed by qualified technicians in accordance with local laws, regulations and the corresponding instruction manual.
- e. In case of any change to the site installation conditions, please appropriately reduce the capacity according to the power cables and air switch specifications provided by the manufacturer.

4 PRODUCT MODEL SELECTION AND COLLOCATION

4.1 Connection diagram

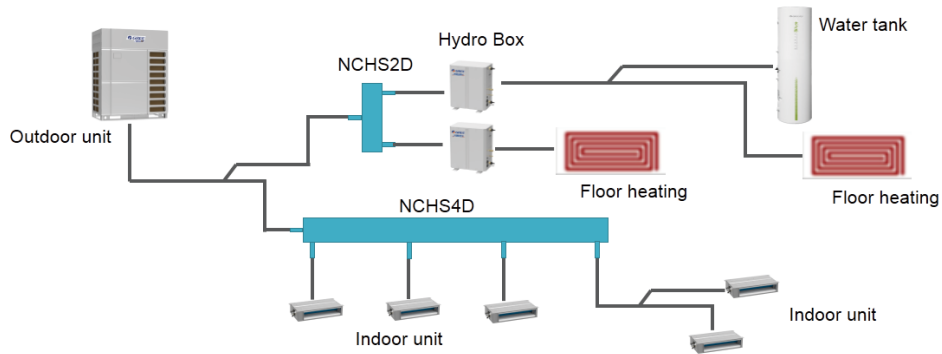

NOTES:

- a. One branch of mode exchange box can only connect one hydro box.
- b. Hydro box and IDU cannot be connected in the same branch.
- c. There must be IDU connected in the system; Hydro box is optional.
- d. If the ERV needs to be connected, the ERV is directly connected to the outdoor unit

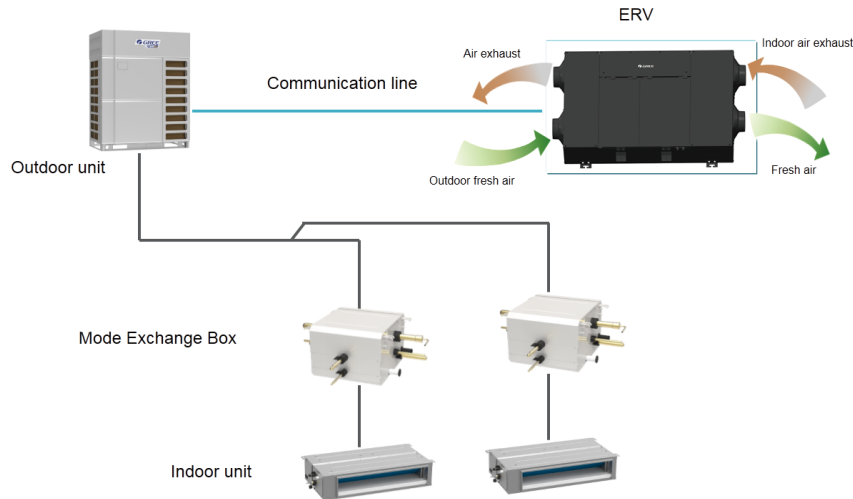

- e. If the ERV+DX Coil needs to be connected, the ERV+DX Coil is connected to the mode exchange box

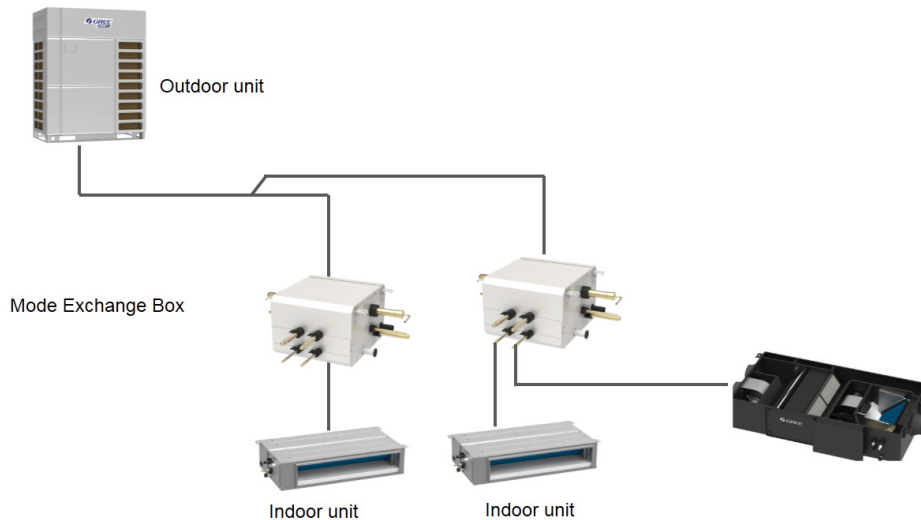

4.2 Selection Step

- ◆ If the customer's demand is: air conditioning
 - (1) IDU selection —select the IDU according to the actual air conditioning load
 - (2) ODU Selection —Select the ODU according to the IDUs
 - (3) Mode Exchanger Selection —Select 1 to 1/2/4/8 according actual requirements.
- ◆ If the customer's demand is: air conditioning + DHW
 - (1) IDU selection —select the IDU according to the actual air conditioning load
 - (2) ODU Selection —Select the ODU according to the IDUs
 - (3) Hydro box, Water Tank Selection
 - Input DWH volume —Input directly the total DWH demand (L)
 - Hydro Box Model and Quantity—Manually select the model and quantity of hydro box according to DWH volume
 - Water Tank Selection —Select one water tank for each hydro box; one hydro box can connect only one water tank
 - (4) Mode Exchanger Selection —Select 1 to 1/2/4/8 according actual requirements.
- ◆ If the customer's demand is: air conditioning + DWH + floor heating and air conditioning + floor heating
 - (1) IDU selection —select the IDU according to the actual air conditioning load
 - (2) ODU Selection —Select the ODU according to the IDUs
 - (3) Hydro box, Water Tank Selection
 - Input DWH volume —Input directly the total DWH demand (L)
 - Hydro Box Model and Quantity—Manually select the model and quantity of hydro box according to DWH volume
 - Water Tank Selection —Select one water tank for each hydro box; one hydro box can connect only one water tank
 - (4) Mode Exchanger Selection —Select 1 to 1/2/4/8 according actual requirements.

4.3 Hydro box selection

4.3.1 Configuration relationship between hydro box and outdoor unit

Outdoor unit model	The requirement of maximum number and capacity of hydro box	Limit of indoor unit ratio to outdoor unit rated capacity
GMV-VQ224WM/C-X	≤2 sets, and the total capacity of hydro box ≤32kW	50%~135%
GMV-VQ280WM/C-X	≤2 sets, and the total capacity of hydro box ≤32kW	
GMV-VQ335WM/C-X	≤2 sets, and the total capacity of hydro box ≤33.5kW	
GMV-VQ400WM/C-X	≤2 sets, and the total capacity of hydro box ≤40kW	
GMV-VQ450WM/C-X	≤2 sets, and the total capacity of hydro box ≤46kW	
GMV-VQ504WM/C-X	≤2 sets, and the total capacity of hydro box ≤50.4kW	
GMV-VQ560WM/C-X	≤2 sets, and the total capacity of hydro box ≤56kW	
GMV-VQ615WM/C-X	≤2 sets, and the total capacity of hydro box ≤61.5kW	
2 modular outdoor units	≤ 4 sets, and the total capacity of hydro box ≤ 100% of the sum of the rated capacity of the outdoor units	
3 or 4 modular outdoor units	≤ 6 sets, and the total capacity of hydro box ≤ 100% of the sum of the rated capacity of the outdoor units	

4.3.2 Hydro box load determination

4.3.2.1 Only domestic hot water load demand

- 1) Determine the total capacity of domestic hot water tank according to user needs
- 2) According to the capacity of the water tank, determine the type and number of the hydro box according to the relationship below

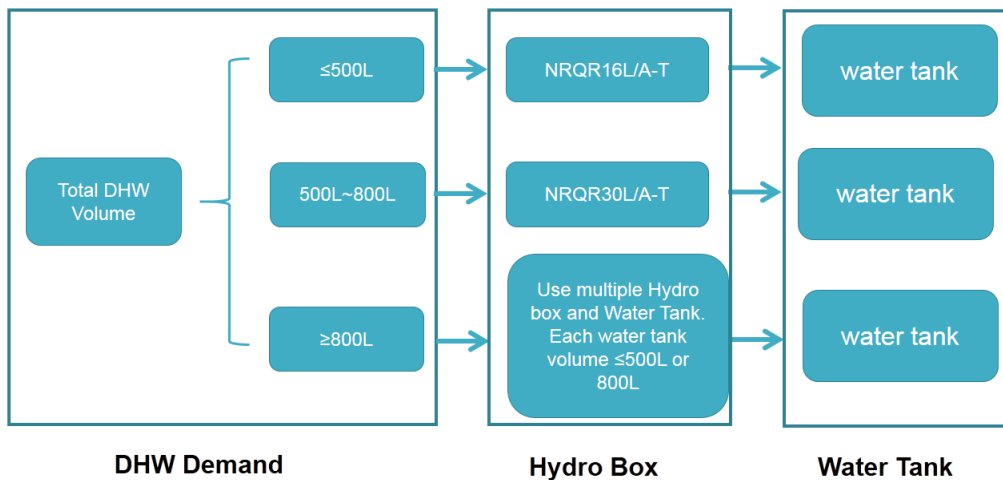

NOTES:

- a. Water tank from Gree or local market is acceptable, only required inner coil water tank.
- b. One hydro box can connect only one water tank

For example:

The total capacity of a domestic hot water tank that a user needs to use is 1500L. According to the above diagram, at least two hot water generators must be selected: one hydro box is connected to an 800L water tank, and the other is connected to a 700L water tank.

4.3.2.2 Only floor heating load demand

- 1) Determine the total floor heating demand according to the room heating demand
- 2) According to the total floor heating demand, determine the type and number of hydro box according to the figure

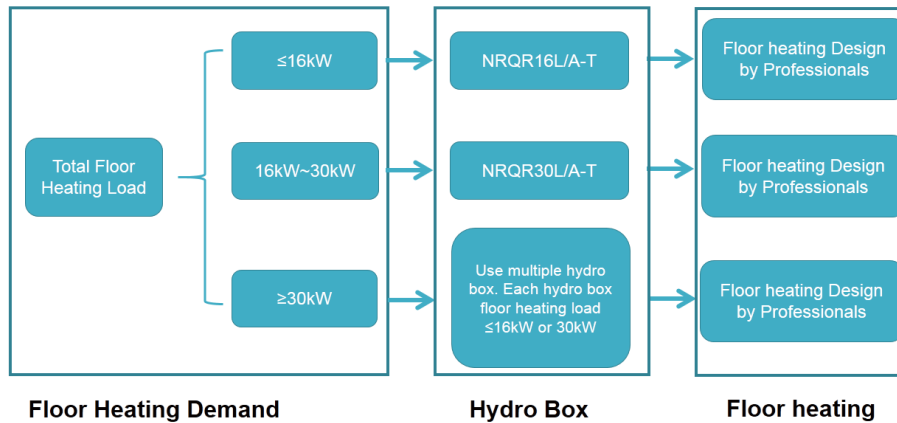

For example:

If the total floor heating load of a user's room is 45kW, at least two hydro boxes must be selected according to the above relationship: one hydro box is connected to the 30kW floor heating load, and the other is connected to the 15kW floor heating load.

4.3.2.3 Demand for hot water and floor heating

- 1) Respectively confirm the total domestic hot water tank capacity and total floor heating demand
- 2) Select the total domestic hot water tank capacity and total floor heating load according to the above
- 3) Compare the total capacity of hydro box and take the largest one to confirm the model and number of generators

For example:

The total capacity of domestic hot water that a user needs to use is 1800L, and the floor heating demand is 45kW

- 1) According to the domestic hot water demand, at least 3 hydro boxes are required

Model	Quantity	Water tank volume
NRQR30L/A-T	1	800L
NRQR30L/A-T	1	800L
NRQR16L/A-T	1	200L

The total capacity of hydro box = 30+30+16=76kW

- 2) According to floor heating demand, at least 2 hydro boxes are required

Model	Quantity	Floor heating demand
NRQR30L/A-T	1	30kW
NRQR30L/A-T	1	15kW

The total capacity of hydro box = 30+16=46kW

The final hydro box is as follows:







Model	Quantity	Water tank volume	Floor heating demand
NRQR30L/A-T	1	800L	30kW
NRQR30L/A-T	1	800L	15kW
NRQR30L/A-T	1	200L	-

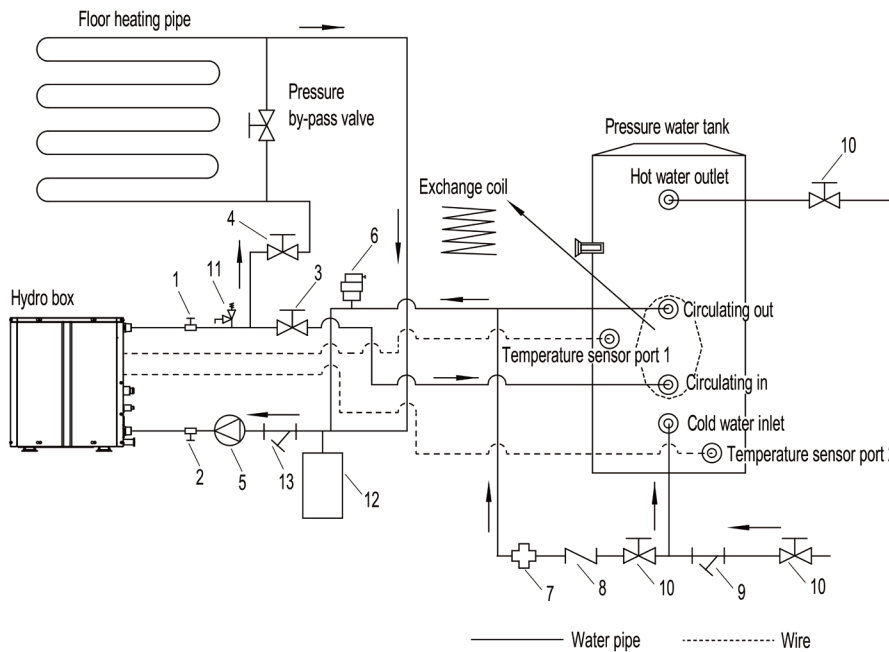





NOTES:

- a. One hydro box can connect only one water tank;
- b. The maximum water tank volume for 16/30kW hydro box is 500/800L respectively;
- c. If the DHW demand is over 800L, it is required to split to multiple hydro box and water tank. Each water tank volume $\leq 500L$ or $800L$;
- d. Each ODU system can connect maximum 2~6 hydro boxes;
- e. One branch of Mode Exchanger can only connect one hydro box;
- f. Hydro box and IDU cannot be connected in the same branch;
- g. If there is both DHW and floor heating in one system, and the required hydro box quantity and

(3) Installation diagram of connecting hydro box with water tank and floor heating simultaneously:



No.	Part's name	Photo	Installation instruction	Purpose	Remark
1	Manual discharge valve A		It should be installed at the high position where is close to the hydro box. The discharge outlet should be upright and face upwards.	Discharge air when debugging the water system.	Standard part
2	Manual discharge valve B		It should be installed at the low position where is close to the hydro box. The discharge outlet should be upright and face downwards.	Discharge the water inside the pipeline during power off period or when maintaining the water system.	Standard part
3	C valve		It should be installed at the water outlet at the flow direction of floor heating hot pipe. Please connect wires according to wiring diagram.	Let the hot water flow into the coil pipe of water tank.	Optional part
4	D valve		It should be installed at the water outlet at the flow direction of floor heating hot pipe. Please connect wires according to wiring diagram.	Make the hot water flow to the floor heating hot pipe.	Optional part
5	Water pump (AC pump)		Select the suitable water pump according to the pressure drop of the water way and the water flow rate in the owner's manual.	Make sure there's enough water flow volume inside the floor heating hot pipe.	Optional part
6	Automatic discharge valve		The highest position of the closed-type water system	Discharge the air inside the system automatically for ensuring excellent heat exchange.	Standard part
7	Pressure-relief valve		It should be installed at the water replenishing outlet of closed-type water system. The water replenishing should be on the backwater way, as shown in the fig.	Make sure the water pressure inside the system is no more than 3bar. Otherwise, the safety valve inside the hydro box will open and it will cause water leakage.	Standard part

No.	Part's name	Photo	Installation instruction	Purpose	Remark
8	Check valve		It should be installed at the water replenishing outlet of the closed-type water system (close to the pressure-relief valve)	Prevent the water inside the closed-type water system flow backwards.	Optional part
9	Strainer		It should be installed at the water replenishing outlet of tap water	For filtrating the impurities in the replenishing water.	
10	Cut-off valve		The cut-off valve connected with the tap water should be kept open; Close the cut-off valve at the water replenishing outlet of closed-type water system after debugging.	It's used for maintenance.	
11	Safety valve		Install at water outlet side of the hydro box.	For pressure relief of the circulating water system.	Standard part
12	Expansion tank		Install at water inlet side of the hydro box.	To prevent pipe cracks caused by water thermal expansion.	Optional part
13	Circulating water strainer		Install at inlet side of the water pump.	For filtrating the impurities in the circulating water	Standard part

5 PRODUCT CAPACITY RECTIFICATION

5.1 Capacity rectification method for IDU and ODU

Actual capacity of each IDU=Actual capacity of ODU×IDU capacity/Max. IDU capacity operating at the same time

Actual capacity of ODU=Rectified capacity based on the configuration rate of IDU and ODU and the indoor and outside temperature condition×pipe distance and the rectification coefficient of fall of IDU and ODU×rectification factor of heating and defrosting

NOTES:

- a. Rectified capacity based on the configuration rate of IDU and ODU and the indoor and outside temperature condition——inquire according to the capacity rectification table.
- b. Rectification factor of heating and defrosting——rectify the factor if the model selection is based on heating load.

➔ 5.2 Correction of capacity along with ambient temperature and configuration ratio

➤ Rectification of cooling capacity:
GMV-VQ224WM/C-X

TC—Total capacity of outdoor unit; PI—Power input of outdoor unit															
Combination	Outdoor air temp (°C DB)	Indoor air temp													
		14.0°C WB		16.0°C WB		18.0°C WB		19.0°C WB		20.0°C WB		22.0°C WB		24.0°C WB	
		20.0°C DB		23.0°C DB		26.0°C DB		27.0°C DB		28.0°C DB		30.0°C DB		32.0°C DB	
		TC	PI	TC	PI	TC	PI	TC	PI	TC	PI	TC	PI	TC	PI
		kW	kW	kW	kW	kW	kW	kW	kW	kW	kW	kW	kW	kW	kW
135%	-5	19.8	2.64	23.6	3.21	27.4	3.25	28.4	3.27	29.0	3.29	29.7	3.33	30.4	3.36
	0	19.8	2.64	23.6	3.22	27.4	3.26	28.4	3.28	29.0	3.29	29.7	3.33	30.4	3.37
	4	19.8	2.65	23.6	3.23	27.4	3.27	28.4	3.29	29.0	3.31	29.7	3.35	30.4	3.38
	7	19.8	2.70	23.6	3.29	27.4	3.33	28.4	3.35	29.0	3.37	29.7	3.41	30.4	3.44
	10	19.8	2.75	23.6	3.36	27.4	4.00	28.4	4.09	28.8	4.01	29.5	3.84	30.2	3.66
	12	19.8	2.80	23.6	3.43	27.4	4.08	28.0	4.06	28.4	3.98	29.1	3.81	29.8	3.75
	14	19.8	2.86	23.6	3.49	27.3	4.13	27.7	4.05	28.0	3.96	28.8	3.93	29.5	3.97
	16	19.8	2.90	23.6	3.56	27.0	4.11	27.3	4.08	27.6	4.10	28.4	4.14	29.1	4.18
	18	19.8	2.96	23.6	3.64	26.6	4.26	26.9	4.29	27.3	4.31	28.0	4.35	28.8	4.39
	20	19.8	3.03	23.6	3.87	26.2	4.47	26.6	4.50	26.9	4.52	27.6	4.56	28.4	4.61
	21	19.8	3.11	23.6	4.01	26.0	4.58	26.4	4.60	26.7	4.63	27.5	4.67	28.2	4.71
	23	19.8	3.33	23.6	4.30	25.7	4.79	26.0	4.81	26.3	4.84	27.1	4.88	27.8	4.93
	25	19.8	3.56	23.6	4.60	25.3	5.00	25.7	5.02	26.0	5.05	26.7	5.10	27.5	5.15
	27	19.8	3.80	23.6	4.92	25.0	4.40	25.3	5.24	25.6	5.26	26.3	5.32	27.1	5.37
	29	19.8	4.06	23.6	5.26	24.6	5.41	24.9	5.45	25.3	5.48	26.0	5.54	26.7	5.59
	31	19.8	4.33	23.5	5.57	24.2	5.63	24.6	5.66	24.9	5.69	25.6	5.75	26.3	5.82
	33	19.8	4.61	23.1	5.78	23.8	5.83	24.2	5.87	24.6	5.91	25.3	5.97	25.9	6.04
	35	19.8	4.92	22.7	5.99	23.4	6.06	23.8	6.09	24.2	6.12	24.9	6.20	25.6	6.26
	37	19.8	5.23	22.4	6.20	23.1	6.28	23.4	6.31	23.8	6.35	24.5	6.42	25.2	6.49
	39	19.8	5.57	22.0	6.41	22.7	6.48	23.1	6.53	23.4	6.57	24.2	6.64	24.9	6.72
41	18.7	6.19	21.6	7.54	22.3	7.63	22.7	7.07	23.0	7.10	23.7	7.19	24.4	7.26	
43	17.7	6.46	21.2	7.86	21.8	8.05	22.2	7.51	22.5	7.37	23.2	7.37	23.9	7.44	
44	17.4	6.73	20.4	8.20	21.2	8.48	21.7	7.98	22.1	7.65	22.8	7.56	23.6	7.64	
47	16.4	8.96	19.8	10.91	20.5	8.91	20.9	8.10	21.3	8.14	22.0	8.12	22.8	8.20	
50	15.1	8.80	17.7	10.72	18.3	9.39	18.7	8.77	19.0	8.69	19.7	8.67	20.5	8.58	
52	9.6	5.21	12.9	6.48	16.0	7.30	17.6	7.66	17.7	7.41	18.1	7.31	19.2	7.50	

TC—Total capacity of outdoor unit; PI—Power input of outdoor unit															
Combination	Outdoor air temp (°C DB)	Indoor air temp													
		14.0°C WB		16.0°C WB		18.0°C WB		19.0°C WB		20.0°C WB		22.0°C WB		24.0°C WB	
		20.0°C DB		23.0°C DB		26.0°C DB		27.0°C DB		28.0°C DB		30.0°C DB		32.0°C DB	
		TC	PI	TC	PI	TC	PI	TC	PI	TC	PI	TC	PI	TC	PI
		kW	kW	kW	kW	kW	kW	kW	kW	kW	kW	kW	kW	kW	
120%	-5	18.3	2.35	21.8	3.04	25.3	3.23	27.1	3.25	28.5	3.27	29.1	3.30	29.8	3.34
	0	18.3	2.35	21.8	3.05	25.3	3.24	27.1	3.26	28.5	3.27	29.1	3.31	29.8	3.34
	4	18.3	2.36	21.8	3.06	25.3	3.25	27.1	3.27	28.5	3.28	29.1	3.32	29.8	3.35
	7	18.3	2.41	21.8	3.12	25.3	3.31	27.1	3.33	28.5	3.35	29.1	3.38	29.8	3.42
	10	18.3	2.51	21.8	3.07	25.3	3.64	27.1	3.94	28.4	4.11	29.0	3.95	29.6	3.80
	12	18.3	2.56	21.8	3.12	25.3	3.72	27.1	4.01	28.0	4.09	28.6	3.93	29.2	3.77
	14	18.3	2.61	21.8	3.19	25.3	3.79	27.1	4.10	27.6	4.06	28.3	3.91	28.9	3.93
	16	18.3	2.66	21.8	3.25	25.3	3.86	26.9	4.13	27.2	4.07	27.9	4.11	28.5	4.14
	18	18.3	2.70	21.8	3.31	25.3	4.00	26.5	4.26	26.8	4.28	27.5	4.32	28.2	4.36
	20	18.3	2.76	21.8	3.44	25.3	4.30	26.2	4.47	26.5	4.49	27.1	4.53	27.8	4.57
	21	18.3	2.78	21.8	3.56	25.3	4.45	25.9	4.58	26.3	4.59	27.0	4.63	27.6	4.68
	23	18.3	2.98	21.8	3.82	25.3	4.76	25.6	4.78	25.9	4.80	26.6	4.85	27.2	4.89
	25	18.3	3.18	21.8	4.09	24.9	4.97	25.2	4.99	25.5	5.01	26.3	5.06	26.9	5.11
	27	18.3	3.40	21.8	4.37	24.6	5.17	24.9	5.21	25.2	5.23	25.9	5.28	26.5	5.33
	29	18.3	3.62	21.8	4.67	24.2	5.38	24.5	5.41	24.8	5.44	25.5	5.50	26.2	5.54
	31	18.3	3.86	21.8	4.98	23.8	5.60	24.2	5.62	24.5	5.66	25.1	5.71	25.8	5.77
	33	18.3	4.11	21.8	5.32	23.4	5.81	23.8	5.84	24.1	5.87	24.7	5.93	25.4	5.99
	35	18.3	4.38	21.8	5.66	23.0	6.02	23.4	6.05	23.8	6.08	24.4	6.15	25.1	6.21
	37	18.3	4.66	21.8	6.03	22.7	6.24	23.0	6.27	23.4	6.30	24.0	6.36	24.7	6.44
	39	18.3	4.96	21.7	6.37	22.3	6.44	22.6	6.48	23.0	6.52	23.7	6.59	24.3	6.65
41	17.3	5.51	20.7	7.14	21.9	7.58	22.2	7.02	22.6	7.06	23.2	7.13	23.9	7.21	
43	16.3	5.75	19.7	7.44	21.5	7.99	21.8	7.46	22.2	7.32	22.8	7.31	23.4	7.39	
44	16.1	6.00	19.6	7.76	20.9	8.43	21.3	7.93	21.7	7.60	22.4	7.50	23.0	7.58	
47	15.2	7.98	18.9	10.33	20.2	8.85	20.5	8.05	20.9	8.09	21.6	8.05	22.3	8.14	
50	13.9	7.83	17.0	10.14	18.0	9.33	18.3	8.71	18.7	8.64	19.3	8.61	20.0	8.51	
52	9.4	5.17	12.7	6.44	15.7	7.25	17.3	7.61	17.4	7.36	17.8	7.26	18.8	7.45	
110%	-5	16.8	2.08	20.0	2.67	23.2	3.21	24.8	3.23	26.4	3.24	28.5	3.28	29.1	3.31
	0	16.8	2.08	20.0	2.68	23.2	3.22	24.8	3.23	26.4	3.25	28.5	3.28	29.1	3.31
	4	16.8	2.09	20.0	2.69	23.2	3.23	24.8	3.25	26.4	3.26	28.5	3.29	29.1	3.32
	7	16.8	2.13	20.0	2.74	23.2	3.29	24.8	3.31	26.4	3.32	28.5	3.35	29.1	3.39
	10	16.8	2.28	20.0	2.78	23.2	3.30	24.8	3.56	26.4	3.84	28.4	4.07	29.1	3.93
	12	16.8	2.33	20.0	2.83	23.2	3.36	24.8	3.64	26.4	3.91	28.1	4.06	28.7	3.91
	14	16.8	2.37	20.0	2.88	23.2	3.43	24.8	3.70	26.4	3.98	27.7	4.06	28.4	3.90
	16	16.8	2.41	20.0	2.94	23.2	3.49	24.8	3.77	26.4	4.06	27.4	4.08	28.0	4.12
	18	16.8	2.45	20.0	2.99	23.2	3.56	24.8	3.88	26.4	4.26	27.0	4.29	27.6	4.33
	20	16.8	2.50	20.0	3.06	23.2	3.77	24.8	4.17	26.0	4.47	26.7	4.50	27.2	4.54
	21	16.8	2.53	20.0	3.15	23.2	3.91	24.8	4.32	25.9	4.57	26.4	4.60	27.1	4.64
	23	16.8	2.65	20.0	3.37	23.2	4.19	24.8	4.63	25.5	4.77	26.1	4.82	26.7	4.86
	25	16.8	2.82	20.0	3.60	23.2	4.48	24.8	4.96	25.1	4.98	25.7	5.03	26.3	5.07
	27	16.8	3.01	20.0	3.85	23.2	4.80	24.4	5.17	24.7	5.19	25.4	5.24	25.9	5.29
	29	16.8	3.21	20.0	4.11	23.2	5.13	24.1	5.38	24.4	5.41	25.0	5.46	25.6	5.50
	31	16.8	3.42	20.0	4.38	23.2	5.47	23.7	5.59	24.0	5.62	24.7	5.66	25.2	5.72
	33	16.8	3.64	20.0	4.67	23.0	5.77	23.4	5.80	23.7	5.83	24.2	5.88	24.9	5.94
	35	16.8	3.87	20.0	4.98	22.7	5.98	23.0	6.01	23.3	6.04	23.8	6.10	24.5	6.16
	37	16.8	4.12	20.0	5.30	22.3	6.20	22.6	6.22	22.9	6.25	23.5	6.32	24.1	6.37
	39	16.8	4.38	20.0	5.65	21.9	6.40	22.2	6.44	22.6	6.47	23.1	6.53	23.8	6.60
41	15.8	4.88	19.0	6.28	21.6	7.53	21.8	6.97	22.1	7.01	22.7	7.07	23.3	7.14	
43	15.0	5.08	18.0	6.54	21.3	7.94	21.4	7.41	21.7	7.28	22.3	7.25	22.9	7.32	
44	14.7	5.30	18.0	6.82	20.6	8.37	20.9	7.87	21.3	7.55	21.8	7.44	22.5	7.51	
47	13.9	7.06	17.4	9.08	19.9	8.79	20.2	7.99	20.5	8.04	21.1	7.99	21.8	8.06	
50	12.7	6.93	15.6	8.91	17.7	9.27	18.0	8.65	18.3	8.58	18.8	8.54	19.6	8.43	
52	9.3	5.14	12.5	6.40	15.4	7.20	17.0	7.56	17.1	7.31	17.5	7.21	18.4	7.40	

GMV6 HR DC Inverter VRF Units Technical Sales Guide

TC—Total capacity of outdoor unit; PI—Power input of outdoor unit

Combination	Outdoor air temp (°C DB)	Indoor air temp													
		14.0°C WB		16.0°C WB		18.0°C WB		19.0°C WB		20.0°C WB		22.0°C WB		24.0°C WB	
		20.0°C DB		23.0°C DB		26.0°C DB		27.0°C DB		28.0°C DB		30.0°C DB		32.0°C DB	
		TC	PI	TC	PI	TC	PI	TC	PI	TC	PI	TC	PI	TC	PI
		kW	kW	kW	kW	kW	kW	kW	kW	kW	kW	kW	kW	kW	
100%	-5	15.2	1.82	18.1	2.33	21.1	2.90	22.4	3.21	24.0	3.22	27.0	3.25	28.5	3.28
	0	15.2	1.82	18.1	2.33	21.1	2.91	22.4	3.21	24.0	3.23	27.0	3.26	28.5	3.29
	4	15.2	1.83	18.1	2.34	21.1	2.92	22.4	3.22	24.0	3.24	27.0	3.27	28.5	3.30
	7	15.2	1.86	18.1	2.38	21.1	2.97	22.4	3.28	24.0	3.30	27.0	3.33	28.5	3.36
	10	15.2	2.06	18.1	2.50	21.1	2.96	22.4	3.20	24.0	3.45	27.0	3.91	28.5	4.06
	12	15.2	2.09	18.1	2.54	21.1	3.00	22.4	3.24	24.0	3.52	27.0	3.97	28.1	4.03
	14	15.2	2.12	18.1	2.58	21.1	3.05	22.4	3.30	24.0	3.58	27.0	4.04	27.8	3.99
	16	15.2	2.17	18.1	2.64	21.1	3.12	22.4	3.37	24.0	3.66	26.9	4.13	27.4	4.08
	18	15.2	2.22	18.1	2.70	21.1	3.18	22.4	3.44	24.0	3.73	26.5	4.21	27.1	4.28
	20	15.2	2.25	18.1	2.74	21.1	3.28	22.4	3.62	24.0	3.97	26.1	4.43	26.7	4.50
	21	15.2	2.28	18.1	2.77	21.1	3.40	22.4	3.74	24.0	4.11	25.9	4.59	26.5	4.63
	23	15.2	2.33	18.1	2.95	21.1	3.65	22.4	4.02	24.0	4.42	25.6	4.85	26.1	4.90
	25	15.2	2.48	18.1	3.14	21.1	3.89	22.4	4.28	24.0	4.72	25.2	5.03	25.8	5.07
	27	15.2	2.65	18.1	3.36	21.1	4.17	22.4	4.59	24.0	5.07	24.8	5.21	25.4	5.25
	29	15.2	2.81	18.1	3.59	21.1	4.46	22.4	4.91	23.9	5.37	24.5	5.46	25.0	5.51
	31	15.2	2.99	18.1	3.82	21.1	4.75	22.4	5.29	23.6	5.59	23.9	5.68	24.7	5.73
	33	15.2	3.18	18.1	4.07	21.1	5.07	22.4	5.60	23.2	5.79	23.8	5.84	24.3	5.89
	35	15.2	3.38	18.1	4.33	21.1	5.40	22.4	5.97	22.8	6.00	23.3	6.05	23.9	6.11
	37	15.2	3.60	18.1	4.61	21.1	5.75	22.2	6.18	22.5	6.22	23.0	6.26	23.6	6.32
	39	15.2	3.84	18.1	4.91	21.1	6.13	21.9	6.39	22.0	6.42	22.7	6.47	23.0	6.52
41	14.4	4.26	17.2	5.46	20.1	6.81	21.4	6.93	21.7	6.96	22.2	7.02	22.8	7.09	
43	13.6	4.45	16.4	5.70	19.6	7.17	21.0	7.36	21.4	7.22	21.7	7.20	22.6	7.27	
44	13.4	4.64	16.3	5.94	19.1	7.56	20.5	7.82	20.8	7.50	21.4	7.39	22.0	7.45	
47	12.6	6.17	15.8	7.90	18.5	7.94	19.8	7.94	20.1	7.98	20.7	7.93	21.3	8.00	
50	11.6	6.06	14.1	7.76	16.5	8.37	17.7	8.60	17.9	8.52	18.4	8.48	19.1	8.37	
52	9.1	4.68	12.2	5.82	15.1	6.55	16.7	6.88	16.8	6.65	17.2	6.56	18.1	6.74	
90%	-5	13.7	1.59	16.3	2.01	19.0	2.48	20.3	2.74	21.6	3.01	24.2	3.22	26.9	3.25
	0	13.7	1.59	16.3	2.01	19.0	2.48	20.3	2.74	21.6	3.02	24.2	3.23	26.9	3.26
	4	13.7	1.59	16.3	2.02	19.0	2.49	20.3	2.75	21.6	3.03	24.2	3.24	26.9	3.27
	7	13.7	1.62	16.3	2.06	19.0	2.54	20.3	2.80	21.6	3.08	24.2	3.30	26.9	3.33
	10	13.7	1.80	16.3	2.16	19.0	2.53	20.3	2.85	21.6	3.03	24.3	3.47	26.9	3.94
	12	13.7	1.82	16.3	2.19	19.0	2.56	20.3	2.89	21.6	3.09	24.3	3.53	26.9	3.99
	14	13.7	1.85	16.3	2.22	19.0	2.61	20.3	2.93	21.6	3.14	24.3	3.59	26.9	4.05
	16	13.7	1.89	16.3	2.27	19.0	2.66	20.3	2.99	21.6	3.21	24.3	3.68	26.8	4.13
	18	13.7	1.94	16.3	2.33	19.0	2.72	20.3	3.05	21.6	3.28	24.3	3.76	26.6	4.28
	20	13.7	1.97	16.3	2.36	19.0	2.81	20.3	3.12	21.6	3.41	24.3	4.04	26.1	4.46
	21	13.7	1.99	16.3	2.39	19.0	2.90	20.3	3.22	21.6	3.53	24.3	4.18	25.9	4.56
	23	13.7	2.04	16.3	2.55	19.0	3.12	20.3	3.46	21.6	3.78	24.3	4.49	25.5	4.79
	25	13.7	2.17	16.3	2.71	19.0	3.32	20.3	3.69	21.6	4.04	24.3	4.80	25.2	4.99
	27	13.7	2.31	16.3	2.90	19.0	3.56	20.3	3.94	21.6	4.33	24.3	5.12	24.8	5.21
	29	13.7	2.45	16.3	3.09	19.0	3.81	20.3	4.21	21.6	4.62	24.0	5.37	24.5	5.42
	31	13.7	2.61	16.3	3.30	19.0	4.06	20.3	4.50	21.6	4.93	23.6	5.56	24.1	5.64
	33	13.7	2.78	16.3	3.51	19.0	4.33	20.3	4.78	21.6	5.24	23.3	5.79	23.8	5.84
	35	13.7	2.95	16.3	3.74	19.0	4.61	20.3	5.10	21.6	5.61	22.9	6.00	23.4	6.05
	37	13.7	3.14	16.3	3.98	19.0	4.91	19.9	5.28	21.6	6.00	22.5	6.22	23.0	6.20
	39	13.7	3.35	16.3	4.24	19.0	5.23	19.7	5.46	21.6	6.36	22.2	6.45	22.6	6.43
41	12.9	3.72	15.5	4.71	18.0	5.81	19.3	5.91	20.5	6.51	21.8	6.96	22.3	7.02	
43	12.2	3.88	14.7	4.91	17.6	6.13	18.9	6.28	20.1	6.75	21.4	7.14	21.9	7.22	
44	12.1	4.04	14.7	5.12	17.2	6.46	18.5	6.68	19.7	7.01	21.0	7.32	21.5	7.39	
47	11.4	5.38	14.2	6.81	16.6	6.78	17.8	6.78	19.0	7.46	20.2	7.86	20.8	7.93	
50	10.4	5.29	12.7	6.69	14.8	7.15	15.9	7.34	17.0	7.96	18.1	8.40	18.7	8.30	
52	8.2	4.36	11.0	5.43	13.6	6.11	15.0	6.42	15.1	6.20	15.6	6.12	16.3	6.28	

TC—Total capacity of outdoor unit; PI—Power input of outdoor unit															
Combination	Outdoor air temp (°C DB)	Indoor air temp													
		14.0°C WB		16.0°C WB		18.0°C WB		19.0°C WB		20.0°C WB		22.0°C WB		24.0°C WB	
		20.0°C DB		23.0°C DB		26.0°C DB		27.0°C DB		28.0°C DB		30.0°C DB		32.0°C DB	
		TC	PI	TC	PI	TC	PI	TC	PI	TC	PI	TC	PI	TC	PI
		kW	kW	kW	kW	kW	kW	kW	kW	kW	kW	kW	kW	kW	
80%	-5	12.2	1.37	14.5	1.69	16.9	2.10	18.0	2.31	19.2	2.53	21.6	3.00	23.9	3.21
	0	12.2	1.37	14.5	1.69	16.9	2.10	18.0	2.32	19.2	2.53	21.6	3.00	23.9	3.22
	4	12.2	1.38	14.5	1.70	16.9	2.11	18.0	2.32	19.2	2.54	21.6	3.02	23.9	3.23
	7	12.2	1.40	14.5	1.73	16.9	2.15	18.0	2.37	19.2	2.59	21.6	3.07	23.9	3.29
	10	12.2	1.63	14.5	1.96	16.9	2.30	18.0	2.48	19.2	2.65	21.6	3.03	23.9	3.52
	12	12.2	1.66	14.5	1.99	16.9	2.34	18.0	2.53	19.2	2.70	21.6	3.08	23.9	3.49
	14	12.2	1.69	14.5	2.03	16.9	2.38	18.0	2.57	19.2	2.75	21.6	3.14	23.9	3.57
	16	12.2	1.71	14.5	2.06	16.9	2.43	18.0	2.61	19.2	2.80	21.6	3.21	23.9	3.70
	18	12.2	1.75	14.5	2.10	16.9	2.48	18.0	2.67	19.2	2.85	21.6	3.28	23.9	3.96
	20	12.2	1.78	14.5	2.14	16.9	2.53	18.0	2.72	19.2	2.91	21.6	3.40	23.9	4.10
	21	12.2	1.79	14.5	2.16	16.9	2.55	18.0	2.75	19.2	2.98	21.6	3.52	23.9	4.39
	23	12.2	1.83	14.5	2.20	16.9	2.67	18.0	2.93	19.2	3.19	21.6	3.77	23.9	4.70
	25	12.2	1.88	14.5	2.34	16.9	2.86	18.0	3.13	19.2	3.40	21.6	4.03	23.9	5.01
	27	12.2	2.00	14.5	2.49	16.9	3.04	18.0	3.34	19.2	3.65	21.6	4.30	23.9	5.19
	29	12.2	2.13	14.5	2.66	16.9	3.24	18.0	3.56	19.1	3.89	21.6	4.59	23.9	5.38
	31	12.2	2.26	14.5	2.82	16.9	3.45	18.0	3.79	19.1	4.15	21.6	4.90	23.5	5.57
	33	12.2	2.41	14.5	3.15	16.9	3.68	18.0	4.04	19.1	4.42	21.6	5.23	23.2	5.77
	35	12.2	2.55	14.5	3.15	16.9	3.91	18.0	4.30	19.1	4.70	21.6	5.58	22.8	5.98
	37	12.2	2.70	14.5	3.39	16.9	4.16	17.7	4.58	19.1	5.01	21.6	5.95	22.5	6.20
	39	12.2	2.86	14.5	3.60	16.9	4.43	17.5	4.88	19.1	5.34	21.6	6.33	22.1	6.43
41	11.5	3.21	13.8	3.96	16.0	4.93	17.2	4.99	18.2	5.46	20.5	6.48	21.7	6.94	
43	10.9	3.35	13.4	4.14	15.6	5.19	16.8	5.31	17.8	5.66	20.1	6.64	21.4	7.12	
44	10.7	3.49	13.1	4.31	15.3	5.47	16.4	5.64	17.5	5.88	19.8	6.81	21.0	7.30	
47	10.1	4.65	12.6	5.74	14.8	5.75	15.8	5.72	16.8	6.26	19.1	7.32	20.3	7.84	
50	9.3	4.57	11.3	5.63	13.2	6.06	14.1	6.20	15.0	6.68	17.1	7.82	18.2	8.20	
52	7.3	3.68	9.8	4.58	12.1	5.16	13.3	5.41	13.4	5.24	13.7	5.16	14.5	5.30	
70%	-5	10.7	1.17	12.7	1.44	14.8	1.75	15.8	1.92	16.8	2.09	18.9	2.46	20.9	2.86
	0	10.7	1.17	12.7	1.45	14.8	1.75	15.8	1.92	16.8	2.10	18.9	2.47	20.9	2.87
	4	10.7	1.17	12.7	1.45	14.8	1.76	15.8	1.93	16.8	2.10	18.9	2.48	20.9	2.88
	7	10.7	1.19	12.7	1.48	14.8	1.79	15.8	1.96	16.8	2.14	18.9	2.52	20.9	2.93
	10	10.7	1.44	12.7	1.71	14.8	1.99	15.8	2.14	16.8	2.29	18.9	2.61	20.9	2.93
	12	10.7	1.46	12.7	1.73	14.8	2.03	15.8	2.18	16.8	2.33	18.9	2.66	20.9	2.99
	14	10.7	1.48	12.7	1.76	14.8	2.06	15.8	2.21	16.8	2.37	18.9	2.70	20.9	3.04
	16	10.7	1.50	12.7	1.79	14.8	2.10	15.8	2.26	16.8	2.42	18.9	2.75	20.9	3.10
	18	10.7	1.53	12.7	1.83	14.8	2.14	15.8	2.30	16.8	2.46	18.9	2.81	20.9	3.16
	20	10.7	1.55	12.7	1.86	14.8	2.18	15.8	2.34	16.8	2.51	18.9	2.86	20.9	3.25
	21	10.7	1.57	12.7	1.87	14.8	2.20	15.8	2.37	16.8	2.53	18.9	2.90	20.9	3.36
	23	10.7	1.59	12.7	1.91	14.8	2.24	15.8	2.45	16.8	2.66	18.9	3.11	20.9	3.60
	25	10.7	1.63	12.7	1.99	14.8	2.39	15.8	2.61	16.8	2.84	18.9	3.33	20.9	3.85
	27	10.7	1.72	12.7	2.12	14.8	2.55	15.8	2.78	16.8	3.03	18.9	3.56	20.9	4.12
	29	10.7	1.83	12.7	2.24	14.8	2.71	15.8	2.97	16.8	3.23	18.9	3.79	20.9	4.40
	31	10.7	1.93	12.7	2.38	14.8	2.89	15.8	3.15	16.8	3.44	18.9	4.04	20.9	4.69
	33	10.7	2.05	12.7	2.53	14.8	3.07	15.8	3.36	16.8	3.66	18.9	4.30	20.9	5.00
	35	10.7	2.17	12.7	2.69	14.8	3.26	15.8	3.57	16.8	3.89	18.9	4.59	20.9	5.33
	37	10.7	2.29	12.7	2.85	14.8	3.47	15.5	3.80	16.8	4.14	18.9	4.88	20.9	5.68
	39	10.7	2.43	12.7	3.02	14.8	3.68	15.3	4.03	16.8	4.40	18.9	5.19	20.9	6.05
41	10.1	2.74	12.1	3.39	14.0	4.11	15.0	4.14	16.0	4.52	18.0	5.32	20.0	6.19	
43	9.5	2.85	11.7	3.53	13.5	4.33	14.7	4.40	15.2	4.69	17.6	5.45	19.4	6.35	
44	9.4	2.98	11.4	3.68	13.4	4.56	14.4	4.68	15.3	4.87	17.3	5.60	19.3	6.51	
47	8.8	3.96	11.0	4.90	12.9	4.79	13.9	4.75	14.8	5.18	16.7	6.01	18.6	6.99	
50	8.1	3.89	9.9	4.81	11.5	5.05	12.4	5.14	13.2	5.53	14.9	6.42	16.8	7.31	
52	6.4	3.05	8.6	3.80	10.6	4.24	11.7	4.49	11.7	4.34	12.0	4.29	12.7	4.40	

GMV6 HR DC Inverter VRF Units Technical Sales Guide

TC—Total capacity of outdoor unit; PI—Power input of outdoor unit

Combination	Outdoor air temp (°C DB)	Indoor air temp													
		14.0°C WB		16.0°C WB		18.0°C WB		19.0°C WB		20.0°C WB		22.0°C WB		24.0°C WB	
		20.0°C DB		23.0°C DB		26.0°C DB		27.0°C DB		28.0°C DB		30.0°C DB		32.0°C DB	
		TC	PI	TC	PI	TC	PI	TC	PI	TC	PI	TC	PI	TC	PI
		kW	kW	kW	kW	kW	kW	kW	kW	kW	kW	kW	kW	kW	
60%	-5	9.1	0.98	10.9	1.20	12.7	1.43	13.5	1.56	14.4	1.70	16.2	1.98	18.0	2.29
	0	9.1	0.98	10.9	1.20	12.7	1.44	13.5	1.57	14.4	1.70	16.2	1.99	18.0	2.29
	4	9.1	0.99	10.9	1.20	12.7	1.44	13.5	1.57	14.4	1.71	16.2	1.99	18.0	2.30
	7	9.1	1.00	10.9	1.23	12.7	1.47	13.5	1.60	14.4	1.74	16.2	2.03	18.0	2.35
	10	9.1	1.25	10.9	1.46	12.7	1.70	13.5	1.82	14.4	1.94	16.2	2.20	18.0	2.46
	12	9.1	1.27	10.9	1.49	12.7	1.73	13.5	1.85	14.4	1.97	16.2	2.24	18.0	2.50
	14	9.1	1.29	10.9	1.51	12.7	1.75	13.5	1.88	14.4	2.01	16.2	2.28	18.0	2.55
	16	9.1	1.30	10.9	1.54	12.7	1.79	13.5	1.91	14.4	2.04	16.2	2.32	18.0	2.60
	18	9.1	1.33	10.9	1.56	12.7	1.82	13.5	1.95	14.4	2.08	16.2	2.36	18.0	2.65
	20	9.1	1.34	10.9	1.59	12.7	1.85	13.5	1.99	14.4	2.12	16.2	2.41	18.0	2.70
	21	9.1	1.36	10.9	1.60	12.7	1.87	13.5	2.00	14.4	2.14	16.2	2.43	18.0	2.73
	23	9.1	1.38	10.9	1.63	12.7	1.90	13.5	2.04	14.4	2.18	16.2	2.53	18.0	2.90
	25	9.1	1.40	10.9	1.67	12.7	1.97	13.5	2.14	14.4	2.32	16.2	2.70	18.0	3.10
	27	9.1	1.46	10.9	1.76	12.7	2.10	13.5	2.29	14.4	2.47	16.2	2.87	18.0	3.31
	29	9.1	1.54	10.9	1.87	12.7	2.24	13.5	2.43	14.4	2.63	16.2	3.07	18.0	3.53
	31	9.1	1.63	10.9	1.99	12.7	2.37	13.5	2.58	14.4	2.80	16.2	3.26	18.0	3.76
	33	9.1	1.72	10.9	2.10	12.7	2.52	13.5	2.74	14.4	2.98	16.2	3.47	18.0	4.01
	35	9.1	1.83	10.9	2.23	12.7	2.67	13.5	2.91	14.4	3.16	16.2	3.69	18.0	4.26
	37	9.1	1.93	10.9	2.36	12.7	2.83	13.3	3.09	14.4	3.36	16.2	3.93	18.0	4.54
	39	9.1	2.04	10.9	2.49	12.7	3.00	13.1	3.27	14.4	3.56	16.2	4.17	18.0	4.83
41	8.6	2.30	10.3	2.81	12.0	3.37	12.9	3.38	13.7	3.67	15.4	4.28	17.1	4.95	
43	8.2	2.40	9.8	2.93	11.7	3.55	12.6	3.59	13.3	3.81	15.2	4.39	16.8	5.08	
44	8.0	2.50	9.8	3.05	11.5	3.74	12.3	3.82	13.1	3.95	14.8	4.51	16.5	5.20	
47	7.6	3.33	9.5	4.06	11.1	3.93	11.9	3.87	12.7	4.21	14.3	4.84	16.0	5.59	
50	6.9	3.27	8.5	3.99	9.9	4.14	10.6	4.19	11.3	4.49	12.8	5.17	14.4	5.84	
52	5.5	2.49	7.3	3.10	9.1	3.49	10.0	3.66	10.1	3.54	10.3	3.49	10.9	3.59	
50%	-5	7.6	0.81	9.1	0.97	10.6	1.15	11.3	1.24	12.0	1.34	13.5	1.56	15.0	1.78
	0	7.6	0.81	9.1	0.97	10.6	1.15	11.3	1.25	12.0	1.35	13.5	1.56	15.0	1.78
	4	7.6	0.82	9.1	0.98	10.6	1.16	11.3	1.25	12.0	1.35	13.5	1.56	15.0	1.79
	7	7.6	0.83	9.1	1.00	10.6	1.18	11.3	1.27	12.0	1.38	13.5	1.59	15.0	1.82
	10	7.6	1.08	9.1	1.25	10.6	1.42	11.3	1.52	12.0	1.61	13.5	1.81	15.0	2.02
	12	7.6	1.09	9.1	1.26	10.6	1.45	11.3	1.54	12.0	1.64	13.5	1.84	15.0	2.05
	14	7.6	1.10	9.1	1.28	10.6	1.46	11.3	1.57	12.0	1.67	13.5	1.87	15.0	2.09
	16	7.6	1.12	9.1	1.30	10.6	1.49	11.3	1.59	12.0	1.69	13.5	1.91	15.0	2.12
	18	7.6	1.13	9.1	1.32	10.6	1.51	11.3	1.62	12.0	1.72	13.5	1.94	15.0	2.16
	20	7.6	1.15	9.1	1.34	10.6	1.54	11.3	1.65	12.0	1.75	13.5	1.98	15.0	2.20
	21	7.6	1.16	9.1	1.35	10.6	1.55	11.3	1.66	12.0	1.77	13.5	2.00	15.0	2.23
	23	7.6	1.17	9.1	1.37	10.6	1.58	11.3	1.69	12.0	1.80	13.5	2.03	15.0	2.28
	25	7.6	1.19	9.1	1.39	10.6	1.61	11.3	1.72	12.0	1.86	13.5	2.13	15.0	2.43
	27	7.6	1.21	9.1	1.45	10.6	1.70	11.3	1.83	12.0	1.97	13.5	2.27	15.0	2.59
	29	7.6	1.28	9.1	1.53	10.6	1.80	11.3	1.95	12.0	2.10	13.5	2.41	15.0	2.76
	31	7.6	1.35	9.1	1.62	10.6	1.92	11.3	2.07	12.0	2.23	13.5	2.57	15.0	2.94
	33	7.6	1.43	9.1	1.71	10.6	2.03	11.3	2.19	12.0	2.37	13.5	2.73	15.0	3.12
	35	7.6	1.51	9.1	1.81	10.6	2.14	11.3	2.32	12.0	2.50	13.5	2.90	15.0	3.31
	37	7.6	1.59	9.1	1.91	10.6	2.27	11.1	2.45	12.0	2.66	13.5	3.07	15.0	3.52
	39	7.6	1.68	9.1	2.02	10.6	2.40	10.9	2.60	12.0	2.82	13.5	3.26	15.0	3.74
41	7.2	1.91	8.6	2.28	10.0	2.70	10.7	2.69	11.4	2.90	12.8	3.36	14.3	3.85	
43	6.8	1.99	8.2	2.39	9.7	2.84	10.5	2.88	11.2	3.02	12.5	3.45	13.9	3.95	
44	6.7	2.07	8.2	2.48	9.6	3.00	10.3	3.04	10.9	3.13	12.4	3.53	13.8	4.04	
47	6.3	2.76	7.9	3.30	9.2	3.15	9.9	3.08	10.5	3.33	11.9	3.79	13.3	4.34	
50	5.8	2.71	7.1	3.24	8.2	3.32	8.8	3.34	9.4	3.55	10.7	4.06	12.0	4.54	
52	4.6	1.98	6.1	2.47	7.6	2.78	8.3	2.91	8.4	2.82	8.6	2.78	9.1	2.85	

GMV-VQ280WM/C-X

TC—Total capacity of outdoor unit; PI—Power input of outdoor unit

Combination	Outdoor air temp (°C DB)	Indoor air temp													
		14.0°C WB		16.0°C WB		18.0°C WB		19.0°C WB		20.0°C WB		22.0°C WB		24.0°C WB	
		20.0°C DB		23.0°C DB		26.0°C DB		27.0°C DB		28.0°C DB		30.0°C DB		32.0°C DB	
		TC	PI	TC	PI	TC	PI	TC	PI	TC	PI	TC	PI	TC	PI
		kW	kW	kW	kW	kW	kW	kW	kW	kW	kW	kW	kW	kW	
135%	-5	24.8	4.13	29.5	5.02	34.2	5.08	35.5	5.11	36.2	5.14	37.1	5.20	38.0	5.25
	0	24.8	4.13	29.5	5.03	34.2	5.09	35.5	5.12	36.2	5.15	37.1	5.21	38.0	5.26
	4	24.8	4.15	29.5	5.05	34.2	5.11	35.5	5.14	36.2	5.17	37.1	5.23	38.0	5.28
	7	24.8	4.23	29.5	5.15	34.2	5.21	35.5	5.24	36.2	5.26	37.1	5.33	38.0	5.38
	10	24.8	4.30	29.5	5.26	34.2	6.25	35.5	6.39	35.9	6.26	36.9	6.00	37.8	5.72
	12	24.8	4.38	29.5	5.36	34.2	6.38	35.0	6.35	35.5	6.22	36.4	5.95	37.3	5.86
	14	24.8	4.46	29.5	5.46	34.1	6.45	34.6	6.32	35.0	6.19	35.9	6.14	36.9	6.20
	16	24.8	4.54	29.5	5.57	33.7	6.43	34.1	6.38	34.5	6.40	35.4	6.46	36.4	6.53
	18	24.8	4.63	29.5	5.68	33.2	6.66	33.6	6.70	34.1	6.74	35.0	6.80	35.9	6.87
	20	24.8	4.73	29.5	6.05	32.7	6.99	33.2	7.03	33.6	7.07	34.5	7.13	35.4	7.20
	21	24.8	4.85	29.5	6.26	32.5	7.15	33.0	7.19	33.4	7.23	34.3	7.31	35.2	7.37
	23	24.8	5.21	29.5	6.71	32.1	7.48	32.5	7.52	32.9	7.56	33.8	7.63	34.7	7.71
	25	24.8	5.56	29.5	7.19	31.6	7.81	32.1	7.85	32.5	7.90	33.4	7.97	34.3	8.05
	27	24.8	5.93	29.5	7.70	31.2	8.88	31.6	8.19	32.0	8.22	32.9	8.31	33.8	8.40
	29	24.8	6.34	29.5	8.22	30.7	8.46	31.1	8.51	31.6	8.56	32.5	8.65	33.4	8.74
	31	24.8	6.76	29.4	8.70	30.2	8.80	30.7	8.85	31.1	8.89	32.0	8.99	32.9	9.09
	33	24.8	7.20	28.9	9.03	29.8	9.12	30.2	9.18	30.7	9.23	31.6	9.33	32.4	9.44
	35	24.8	7.68	28.4	9.36	29.3	9.47	29.8	9.52	30.2	9.57	31.1	9.68	32.0	9.78
	37	24.8	8.17	28.0	9.69	28.9	9.81	29.3	9.86	29.8	9.92	30.6	10.03	31.5	10.15
	39	24.8	8.70	27.5	10.02	28.4	10.13	28.9	10.20	29.3	10.26	30.2	10.37	31.1	10.50
41	23.4	9.68	27.0	11.79	27.8	11.93	28.3	11.04	28.7	11.10	29.6	11.23	30.5	11.35	
43	22.1	10.09	26.5	12.29	27.3	12.58	27.8	11.73	28.2	11.52	29.0	11.51	29.9	11.63	
44	21.8	10.53	25.6	12.82	26.5	13.26	27.1	12.47	27.6	11.96	28.5	11.81	29.5	11.93	
47	20.6	14.01	24.7	17.05	25.6	13.92	26.2	12.66	26.6	12.73	27.5	12.68	28.5	12.82	
50	18.8	13.75	22.1	16.75	22.9	14.68	23.3	13.71	23.7	13.59	24.6	13.55	25.6	13.40	
52	12.0	8.14	16.2	10.13	20.0	11.40	22.0	11.97	22.1	11.58	22.7	11.42	24.0	11.73	
120%	-5	22.9	3.67	27.2	4.75	31.6	5.05	33.8	5.08	35.6	5.10	36.4	5.16	37.2	5.21
	0	22.9	3.68	27.2	4.76	31.6	5.06	33.8	5.09	35.6	5.11	36.4	5.17	37.2	5.22
	4	22.9	3.69	27.2	4.78	31.6	5.08	33.8	5.11	35.6	5.13	36.4	5.19	37.2	5.24
	7	22.9	3.76	27.2	4.87	31.6	5.17	33.8	5.20	35.6	5.23	36.4	5.28	37.2	5.34
	10	22.9	3.92	27.2	4.79	31.6	5.70	33.8	6.16	35.4	6.43	36.3	6.17	37.1	5.93
	12	22.9	4.00	27.2	4.88	31.6	5.81	33.8	6.27	34.9	6.39	35.7	6.15	36.6	5.90
	14	22.9	4.07	27.2	4.98	31.6	5.92	33.8	6.40	34.4	6.35	35.3	6.11	36.2	6.15
	16	22.9	4.15	27.2	5.08	31.6	6.04	33.6	6.45	34.0	6.36	34.8	6.43	35.6	6.48
	18	22.9	4.22	27.2	5.18	31.6	6.25	33.1	6.66	33.5	6.69	34.3	6.75	35.2	6.82
	20	22.9	4.31	27.2	5.38	31.6	6.71	32.7	6.99	33.1	7.02	33.9	7.08	34.7	7.14
	21	22.9	4.35	27.2	5.57	31.6	6.95	32.4	7.15	32.8	7.18	33.7	7.24	34.5	7.32
	23	22.9	4.65	27.2	5.97	31.6	7.44	32.0	7.47	32.4	7.51	33.2	7.58	34.0	7.65
	25	22.9	4.97	27.2	6.39	31.1	7.77	31.5	7.80	31.9	7.83	32.8	7.91	33.6	7.98
	27	22.9	5.31	27.2	6.83	30.7	8.09	31.1	8.14	31.5	8.17	32.3	8.25	33.1	8.32
	29	22.9	5.66	27.2	7.29	30.2	8.41	30.6	8.46	31.0	8.50	31.8	8.59	32.7	8.66
	31	22.9	6.04	27.2	7.78	29.8	8.75	30.2	8.79	30.6	8.84	31.4	8.93	32.2	9.02
	33	22.9	6.43	27.2	8.31	29.3	9.08	29.7	9.13	30.1	9.17	30.9	9.27	31.7	9.36
	35	22.9	6.84	27.2	8.85	28.8	9.41	29.2	9.46	29.7	9.51	30.5	9.61	31.3	9.71
	37	22.9	7.28	27.2	9.43	28.4	9.74	28.8	9.80	29.2	9.85	30.0	9.95	30.8	10.06
	39	22.9	7.75	27.1	9.96	27.9	10.07	28.3	10.13	28.7	10.19	29.6	10.30	30.4	10.40
41	21.6	8.62	25.8	11.15	27.4	11.85	27.8	10.97	28.3	11.03	29.0	11.14	29.8	11.26	
43	20.4	8.98	24.6	11.63	26.8	12.49	27.2	11.65	27.8	11.45	28.5	11.43	29.3	11.55	
44	20.1	9.37	24.5	12.13	26.1	13.17	26.6	12.39	27.1	11.88	27.9	11.72	28.8	11.84	
47	19.0	12.47	23.7	16.14	25.2	13.83	25.6	12.58	26.1	12.64	27.0	12.58	27.9	12.72	
50	17.4	12.24	21.2	15.85	22.5	14.58	22.9	13.62	23.3	13.50	24.1	13.45	25.1	13.30	
52	11.8	8.09	15.9	10.07	19.6	11.33	21.6	11.89	21.7	11.50	22.2	11.35	23.5	11.65	

GMV6 HR DC Inverter VRF Units Technical Sales Guide

TC—Total capacity of outdoor unit; PI—Power input of outdoor unit

Combination	Outdoor air temp (°C DB)	Indoor air temp													
		14.0°C WB		16.0°C WB		18.0°C WB		19.0°C WB		20.0°C WB		22.0°C WB		24.0°C WB	
		20.0°C DB		23.0°C DB		26.0°C DB		27.0°C DB		28.0°C DB		30.0°C DB		32.0°C DB	
		TC	PI	TC	PI	TC	PI	TC	PI	TC	PI	TC	PI	TC	PI
		kW	kW	kW	kW	kW	kW	kW	kW	kW	kW	kW	kW	kW	
110%	-5	20.9	3.25	25.0	4.18	29.0	5.02	31.0	5.04	33.0	5.07	35.6	5.12	36.3	5.17
	0	20.9	3.25	25.0	4.19	29.0	5.03	31.0	5.05	33.0	5.08	35.6	5.13	36.3	5.18
	4	20.9	3.27	25.0	4.20	29.0	5.04	31.0	5.07	33.0	5.10	35.6	5.15	36.3	5.19
	7	20.9	3.33	25.0	4.28	29.0	5.14	31.0	5.17	33.0	5.19	35.6	5.24	36.3	5.29
	10	20.9	3.56	25.0	4.34	29.0	5.16	31.0	5.57	33.0	6.00	35.5	6.36	36.4	6.15
	12	20.9	3.63	25.0	4.43	29.0	5.26	31.0	5.68	33.0	6.11	35.1	6.34	35.8	6.11
	14	20.9	3.70	25.0	4.50	29.0	5.36	31.0	5.78	33.0	6.22	34.6	6.34	35.4	6.10
	16	20.9	3.76	25.0	4.59	29.0	5.46	31.0	5.90	33.0	6.35	34.2	6.38	34.9	6.44
	18	20.9	3.84	25.0	4.68	29.0	5.57	31.0	6.06	33.0	6.65	33.7	6.70	34.5	6.76
	20	20.9	3.91	25.0	4.78	29.0	5.90	31.0	6.51	32.5	6.98	33.3	7.03	34.0	7.09
	21	20.9	3.95	25.0	4.92	29.0	6.11	31.0	6.75	32.3	7.14	33.0	7.19	33.8	7.26
	23	20.9	4.14	25.0	5.27	29.0	6.55	31.0	7.24	31.8	7.46	32.6	7.53	33.3	7.59
	25	20.9	4.40	25.0	5.63	29.0	7.00	31.0	7.76	31.4	7.78	32.1	7.86	32.9	7.92
	27	20.9	4.70	25.0	6.02	29.0	7.49	30.5	8.09	30.9	8.11	31.7	8.19	32.4	8.26
	29	20.9	5.02	25.0	6.43	29.0	8.01	30.1	8.41	30.5	8.45	31.2	8.53	32.0	8.60
	31	20.9	5.34	25.0	6.85	29.0	8.55	29.6	8.74	30.0	8.78	30.8	8.85	31.5	8.94
	33	20.9	5.68	25.0	7.31	28.8	9.02	29.2	9.07	29.6	9.10	30.3	9.19	31.1	9.28
	35	20.9	6.05	25.0	7.78	28.4	9.34	28.7	9.39	29.1	9.44	29.8	9.53	30.6	9.62
	37	20.9	6.44	25.0	8.29	27.9	9.68	28.3	9.72	28.6	9.77	29.4	9.87	30.1	9.96
	39	20.9	6.84	25.0	8.83	27.4	10.01	27.8	10.06	28.2	10.11	28.9	10.21	29.7	10.31
41	19.8	7.62	23.7	9.81	27.0	11.77	27.3	10.90	27.7	10.95	28.4	11.06	29.2	11.16	
43	18.7	7.95	22.5	10.23	26.6	12.41	26.8	11.58	27.2	11.37	27.9	11.34	28.7	11.44	
44	18.4	8.29	22.5	10.66	25.7	13.08	26.1	12.30	26.6	11.80	27.3	11.63	28.2	11.74	
47	17.4	11.03	21.7	14.19	24.8	13.73	25.2	12.49	25.6	12.56	26.4	12.49	27.2	12.60	
50	15.9	10.83	19.5	13.93	22.2	14.48	22.5	13.53	22.8	13.41	23.5	13.34	24.5	13.18	
52	11.6	8.03	15.6	10.00	19.3	11.25	21.2	11.81	21.3	11.42	21.8	11.27	23.1	11.57	
100%	-5	19.0	2.84	22.7	3.64	26.4	4.53	28.0	5.01	30.0	5.04	33.7	5.08	35.6	5.13
	0	19.0	2.85	22.7	3.64	26.4	4.54	28.0	5.02	30.0	5.04	33.7	5.09	35.6	5.14
	4	19.0	2.86	22.7	3.66	26.4	4.56	28.0	5.04	30.0	5.06	33.7	5.11	35.6	5.15
	7	19.0	2.91	22.7	3.72	26.4	4.64	28.0	5.13	30.0	5.16	33.7	5.20	35.6	5.25
	10	19.0	3.22	22.7	3.91	26.4	4.63	28.0	4.99	30.0	5.39	33.7	6.10	35.6	6.34
	12	19.0	3.26	22.7	3.96	26.4	4.69	28.0	5.06	30.0	5.50	33.7	6.21	35.1	6.29
	14	19.0	3.32	22.7	4.03	26.4	4.77	28.0	5.15	30.0	5.60	33.7	6.32	34.7	6.24
	16	19.0	3.39	22.7	4.12	26.4	4.87	28.0	5.27	30.0	5.72	33.6	6.46	34.2	6.38
	18	19.0	3.47	22.7	4.21	26.4	4.97	28.0	5.37	30.0	5.84	33.1	6.58	33.8	6.68
	20	19.0	3.52	22.7	4.28	26.4	5.13	28.0	5.65	30.0	6.21	32.6	6.93	33.3	7.04
	21	19.0	3.56	22.7	4.32	26.4	5.31	28.0	5.85	30.0	6.42	32.4	7.17	33.1	7.23
	23	19.0	3.65	22.7	4.62	26.4	5.71	28.0	6.29	30.0	6.90	32.0	7.58	32.6	7.65
	25	19.0	3.88	22.7	4.91	26.4	6.07	28.0	6.69	30.0	7.38	31.5	7.86	32.2	7.93
	27	19.0	4.15	22.7	5.25	26.4	6.52	28.0	7.18	30.0	7.92	31.0	8.14	31.7	8.21
	29	19.0	4.39	22.7	5.61	26.4	6.97	28.0	7.67	29.9	8.39	30.6	8.53	31.3	8.60
	31	19.0	4.67	22.7	5.97	26.4	7.43	28.0	8.27	29.5	8.73	29.9	8.87	30.8	8.95
	33	19.0	4.97	22.7	6.36	26.4	7.92	28.0	8.75	29.0	9.05	29.7	9.13	30.4	9.21
	35	19.0	5.29	22.7	6.77	26.4	8.44	28.0	9.33	28.5	9.38	29.2	9.46	29.9	9.55
	37	19.0	5.63	22.7	7.21	26.4	8.99	27.7	9.67	28.1	9.71	28.8	9.78	29.5	9.87
	39	19.0	6.00	22.7	7.68	26.4	9.58	27.3	9.98	27.5	10.03	28.4	10.11	28.8	10.20
41	18.0	6.66	21.5	8.53	25.1	10.64	26.8	10.82	27.1	10.88	27.8	10.97	28.5	11.07	
43	17.0	6.95	20.4	8.90	24.5	11.21	26.3	11.50	26.7	11.29	27.2	11.26	28.2	11.36	
44	16.7	7.25	20.4	9.28	23.9	11.82	25.7	12.22	26.0	11.72	26.7	11.54	27.5	11.65	
47	15.8	9.64	19.7	12.35	23.1	12.41	24.8	12.41	25.1	12.47	25.8	12.39	26.6	12.51	
50	14.5	9.47	17.7	12.12	20.6	13.09	22.1	13.44	22.4	13.31	23.1	13.25	23.9	13.08	
52	11.4	7.31	15.3	9.10	18.9	10.24	20.8	10.75	20.9	10.40	21.4	10.26	22.7	10.53	

TC—Total capacity of outdoor unit; PI—Power input of outdoor unit															
Combination	Outdoor air temp (°C DB)	Indoor air temp													
		14.0°C WB		16.0°C WB		18.0°C WB		19.0°C WB		20.0°C WB		22.0°C WB		24.0°C WB	
		20.0°C DB		23.0°C DB		26.0°C DB		27.0°C DB		28.0°C DB		30.0°C DB		32.0°C DB	
		TC	PI	TC	PI	TC	PI	TC	PI	TC	PI	TC	PI	TC	PI
		kW	kW	kW	kW	kW	kW	kW	kW	kW	kW	kW	kW	kW	
90%	-5	17.1	2.48	20.4	3.14	23.7	3.87	25.4	4.28	27.0	4.71	30.3	5.04	33.6	5.08
	0	17.1	2.48	20.4	3.14	23.7	3.88	25.4	4.29	27.0	4.72	30.3	5.05	33.6	5.09
	4	17.1	2.49	20.4	3.15	23.7	3.89	25.4	4.30	27.0	4.73	30.3	5.06	33.6	5.11
	7	17.1	2.54	20.4	3.21	23.7	3.97	25.4	4.38	27.0	4.82	30.3	5.16	33.6	5.20
	10	17.1	2.81	20.4	3.37	23.7	3.95	25.4	4.45	27.0	4.74	30.4	5.43	33.6	6.15
	12	17.1	2.85	20.4	3.42	23.7	4.00	25.4	4.51	27.0	4.83	30.4	5.52	33.6	6.23
	14	17.1	2.89	20.4	3.48	23.7	4.07	25.4	4.58	27.0	4.91	30.4	5.62	33.6	6.33
	16	17.1	2.96	20.4	3.55	23.7	4.16	25.4	4.68	27.0	5.02	30.4	5.74	33.5	6.46
	18	17.1	3.03	20.4	3.63	23.7	4.24	25.4	4.77	27.0	5.12	30.4	5.88	33.2	6.69
	20	17.1	3.07	20.4	3.69	23.7	4.38	25.4	4.87	27.0	5.33	30.4	6.31	32.6	6.97
	21	17.1	3.10	20.4	3.73	23.7	4.53	25.4	5.03	27.0	5.52	30.4	6.53	32.4	7.12
	23	17.1	3.18	20.4	3.98	23.7	4.87	25.4	5.41	27.0	5.91	30.4	7.01	31.9	7.49
	25	17.1	3.39	20.4	4.24	23.7	5.19	25.4	5.77	27.0	6.32	30.4	7.50	31.5	7.80
	27	17.1	3.62	20.4	4.53	23.7	5.56	25.4	6.16	27.0	6.76	30.4	8.01	31.0	8.14
	29	17.1	3.83	20.4	4.84	23.7	5.95	25.4	6.58	27.0	7.22	30.0	8.39	30.6	8.47
	31	17.1	4.08	20.4	5.15	23.7	6.34	25.4	7.03	27.0	7.70	29.5	8.70	30.1	8.81
	33	17.1	4.34	20.4	5.48	23.7	6.76	25.4	7.47	27.0	8.19	29.1	9.05	29.7	9.13
	35	17.1	4.61	20.4	5.84	23.7	7.21	25.4	7.97	27.0	8.76	28.6	9.38	29.2	9.46
	37	17.1	4.91	20.4	6.22	23.7	7.68	24.9	8.25	27.0	9.38	28.1	9.72	28.8	9.69
	39	17.1	5.23	20.4	6.62	23.7	8.18	24.6	8.53	27.0	9.94	27.7	10.08	28.3	10.05
41	16.2	5.81	19.4	7.36	22.6	9.09	24.1	9.24	25.7	10.17	27.2	10.88	27.8	10.98	
43	15.3	6.06	18.4	7.67	22.0	9.58	23.7	9.82	25.2	10.56	26.8	11.16	27.4	11.28	
44	15.1	6.32	18.4	8.00	21.5	10.10	23.1	10.44	24.7	10.96	26.2	11.44	26.9	11.54	
47	14.2	8.41	17.7	10.65	20.8	10.60	22.3	10.60	23.8	11.66	25.3	12.29	26.0	12.40	
50	13.0	8.26	15.9	10.46	18.5	11.18	19.9	11.47	21.2	12.45	22.6	13.13	23.4	12.96	
52	10.2	6.82	13.8	8.49	17.0	9.55	18.8	10.03	18.9	9.70	19.5	9.57	20.4	9.82	
80%	-5	15.2	2.14	18.1	2.64	21.1	3.28	22.6	3.61	24.0	3.95	27.0	4.69	29.9	5.02
	0	15.2	2.14	18.1	2.65	21.1	3.29	22.6	3.62	24.0	3.96	27.0	4.70	29.9	5.03
	4	15.2	2.15	18.1	2.65	21.1	3.30	22.6	3.63	24.0	3.97	27.0	4.71	29.9	5.05
	7	15.2	2.19	18.1	2.70	21.1	3.36	22.6	3.70	24.0	4.04	27.0	4.80	29.9	5.14
	10	15.2	2.55	18.1	3.06	21.1	3.60	22.6	3.87	24.0	4.15	27.0	4.74	29.9	5.50
	12	15.2	2.59	18.1	3.11	21.1	3.66	22.6	3.95	24.0	4.23	27.0	4.82	29.9	5.46
	14	15.2	2.64	18.1	3.17	21.1	3.72	22.6	4.01	24.0	4.30	27.0	4.90	29.9	5.58
	16	15.2	2.68	18.1	3.22	21.1	3.80	22.6	4.09	24.0	4.37	27.0	5.01	29.9	5.78
	18	15.2	2.73	18.1	3.28	21.1	3.88	22.6	4.17	24.0	4.45	27.0	5.13	29.9	6.19
	20	15.2	2.78	18.1	3.34	21.1	3.95	22.6	4.25	24.0	4.55	27.0	5.31	29.9	6.41
	21	15.2	2.80	18.1	3.37	21.1	3.99	22.6	4.30	24.0	4.66	27.0	5.50	29.9	6.86
	23	15.2	2.85	18.1	3.45	21.1	4.17	22.6	4.58	24.0	4.98	27.0	5.89	29.9	7.34
	25	15.2	2.94	18.1	3.66	21.1	4.46	22.6	4.89	24.0	5.32	27.0	6.30	29.9	7.83
	27	15.2	3.13	18.1	3.90	21.1	4.75	22.6	5.22	24.0	5.70	27.0	6.73	29.9	8.11
	29	15.2	3.33	18.1	4.15	21.1	5.07	22.6	5.56	23.9	6.08	27.0	7.18	29.9	8.40
	31	15.2	3.53	18.1	4.41	21.1	5.39	22.6	5.92	23.9	6.48	27.0	7.66	29.4	8.71
	33	15.2	3.76	18.1	4.92	21.1	5.75	22.6	6.31	23.9	6.90	27.0	8.18	29.0	9.02
	35	15.2	3.99	18.1	4.92	21.1	6.11	22.6	6.73	23.9	7.35	27.0	8.73	28.5	9.35
	37	15.2	4.22	18.1	5.29	21.1	6.50	22.2	7.16	23.9	7.83	27.0	9.29	28.1	9.70
	39	15.2	4.48	18.1	5.62	21.1	6.92	21.9	7.63	23.9	8.34	27.0	9.90	27.6	10.06
41	14.4	5.02	17.2	6.19	20.1	7.70	21.4	7.80	22.8	8.53	25.7	10.12	27.2	10.85	
43	13.6	5.23	16.7	6.46	19.5	8.11	21.0	8.30	22.3	8.85	25.2	10.38	26.7	11.12	
44	13.4	5.46	16.3	6.74	19.1	8.56	20.5	8.81	21.8	9.19	24.7	10.65	26.2	11.41	
47	12.6	7.27	15.8	8.96	18.5	8.98	19.8	8.95	21.1	9.78	23.9	11.43	25.4	12.25	
50	11.6	7.13	14.1	8.80	16.5	9.47	17.7	9.69	18.8	10.44	21.3	12.22	22.8	12.81	
52	9.1	5.75	12.2	7.16	15.1	8.06	16.7	8.46	16.8	8.18	17.2	8.07	18.1	8.29	

GMV6 HR DC Inverter VRF Units Technical Sales Guide

TC—Total capacity of outdoor unit; PI—Power input of outdoor unit

Combination	Outdoor air temp (°C DB)	Indoor air temp													
		14.0°C WB		16.0°C WB		18.0°C WB		19.0°C WB		20.0°C WB		22.0°C WB		24.0°C WB	
		20.0°C DB		23.0°C DB		26.0°C DB		27.0°C DB		28.0°C DB		30.0°C DB		32.0°C DB	
		TC	PI	TC	PI	TC	PI	TC	PI	TC	PI	TC	PI	TC	PI
		kW	kW	kW	kW	kW	kW	kW	kW	kW	kW	kW	kW	kW	
70%	-5	13.3	1.82	15.9	2.26	18.5	2.73	19.7	3.00	21.0	3.27	23.6	3.85	26.2	4.48
	0	13.3	1.83	15.9	2.26	18.5	2.74	19.7	3.00	21.0	3.27	23.6	3.86	26.2	4.49
	4	13.3	1.83	15.9	2.27	18.5	2.75	19.7	3.01	21.0	3.29	23.6	3.87	26.2	4.50
	7	13.3	1.87	15.9	2.31	18.5	2.80	19.7	3.07	21.0	3.35	23.6	3.94	26.2	4.59
	10	13.3	2.25	15.9	2.67	18.5	3.11	19.7	3.34	21.0	3.58	23.6	4.07	26.2	4.58
	12	13.3	2.28	15.9	2.70	18.5	3.17	19.7	3.41	21.0	3.65	23.6	4.15	26.2	4.66
	14	13.3	2.31	15.9	2.75	18.5	3.22	19.7	3.46	21.0	3.71	23.6	4.22	26.2	4.75
	16	13.3	2.35	15.9	2.80	18.5	3.28	19.7	3.53	21.0	3.78	23.6	4.30	26.2	4.84
	18	13.3	2.39	15.9	2.85	18.5	3.34	19.7	3.60	21.0	3.85	23.6	4.39	26.2	4.94
	20	13.3	2.43	15.9	2.90	18.5	3.41	19.7	3.66	21.0	3.92	23.6	4.48	26.2	5.08
	21	13.3	2.45	15.9	2.93	18.5	3.43	19.7	3.70	21.0	3.96	23.6	4.53	26.2	5.26
	23	13.3	2.49	15.9	2.98	18.5	3.51	19.7	3.82	21.0	4.16	23.6	4.87	26.2	5.63
	25	13.3	2.54	15.9	3.11	18.5	3.73	19.7	4.09	21.0	4.44	23.6	5.21	26.2	6.02
	27	13.3	2.69	15.9	3.31	18.5	3.99	19.7	4.35	21.0	4.74	23.6	5.56	26.2	6.44
	29	13.3	2.85	15.9	3.51	18.5	4.24	19.7	4.64	21.0	5.04	23.6	5.92	26.2	6.88
	31	13.3	3.02	15.9	3.72	18.5	4.51	19.7	4.93	21.0	5.37	23.6	6.31	26.2	7.33
	33	13.3	3.21	15.9	3.96	18.5	4.80	19.7	5.24	21.0	5.72	23.6	6.73	26.2	7.82
	35	13.3	3.40	15.9	4.20	18.5	5.09	19.7	5.58	21.0	6.09	23.6	7.17	26.2	8.34
	37	13.3	3.58	15.9	4.45	18.5	5.42	19.4	5.93	21.0	6.48	23.6	7.63	26.2	8.88
	39	13.3	3.80	15.9	4.72	18.5	5.75	19.1	6.30	21.0	6.88	23.6	8.11	26.2	9.46
41	12.6	4.28	15.1	5.29	17.5	6.42	18.8	6.48	20.0	7.06	22.5	8.31	25.0	9.67	
43	11.9	4.46	14.6	5.52	16.9	6.76	18.4	6.88	19.0	7.33	22.1	8.52	24.3	9.92	
44	11.7	4.65	14.3	5.75	16.7	7.13	18.0	7.31	19.2	7.61	21.6	8.74	24.1	10.17	
47	11.1	6.19	13.8	7.66	16.2	7.49	17.3	7.43	18.5	8.09	20.9	9.39	23.3	10.92	
50	10.1	6.08	12.4	7.52	14.4	7.89	15.5	8.04	16.5	8.64	18.6	10.03	20.9	11.42	
52	8.0	4.77	10.7	5.94	13.3	6.63	14.6	7.02	14.7	6.79	15.0	6.70	15.9	6.88	
60%	-5	11.4	1.53	13.6	1.87	15.8	2.24	16.9	2.44	18.0	2.65	20.2	3.10	22.5	3.58
	0	11.4	1.54	13.6	1.87	15.8	2.25	16.9	2.45	18.0	2.66	20.2	3.11	22.5	3.59
	4	11.4	1.54	13.6	1.88	15.8	2.25	16.9	2.46	18.0	2.67	20.2	3.12	22.5	3.60
	7	11.4	1.57	13.6	1.92	15.8	2.30	16.9	2.50	18.0	2.72	20.2	3.17	22.5	3.67
	10	11.4	1.95	13.6	2.29	15.8	2.65	16.9	2.84	18.0	3.03	20.2	3.43	22.5	3.85
	12	11.4	1.99	13.6	2.33	15.8	2.70	16.9	2.89	18.0	3.08	20.2	3.50	22.5	3.91
	14	11.4	2.01	13.6	2.36	15.8	2.74	16.9	2.94	18.0	3.14	20.2	3.56	22.5	3.99
	16	11.4	2.04	13.6	2.40	15.8	2.79	16.9	2.99	18.0	3.19	20.2	3.62	22.5	4.06
	18	11.4	2.07	13.6	2.44	15.8	2.84	16.9	3.04	18.0	3.26	20.2	3.68	22.5	4.14
	20	11.4	2.10	13.6	2.49	15.8	2.89	16.9	3.11	18.0	3.32	20.2	3.76	22.5	4.22
	21	11.4	2.13	13.6	2.50	15.8	2.92	16.9	3.13	18.0	3.34	20.2	3.80	22.5	4.26
	23	11.4	2.15	13.6	2.55	15.8	2.97	16.9	3.19	18.0	3.41	20.2	3.95	22.5	4.54
	25	11.4	2.19	13.6	2.60	15.8	3.08	16.9	3.34	18.0	3.62	20.2	4.21	22.5	4.84
	27	11.4	2.28	13.6	2.75	15.8	3.28	16.9	3.57	18.0	3.86	20.2	4.49	22.5	5.17
	29	11.4	2.40	13.6	2.92	15.8	3.50	16.9	3.80	18.0	4.11	20.2	4.79	22.5	5.52
	31	11.4	2.55	13.6	3.11	15.8	3.71	16.9	4.04	18.0	4.38	20.2	5.09	22.5	5.87
	33	11.4	2.69	13.6	3.28	15.8	3.94	16.9	4.29	18.0	4.65	20.2	5.42	22.5	6.26
	35	11.4	2.85	13.6	3.48	15.8	4.17	16.9	4.55	18.0	4.94	20.2	5.77	22.5	6.66
	37	11.4	3.02	13.6	3.68	15.8	4.43	16.6	4.83	18.0	5.24	20.2	6.14	22.5	7.09
	39	11.4	3.18	13.6	3.90	15.8	4.69	16.4	5.12	18.0	5.57	20.2	6.51	22.5	7.54
41	10.8	3.60	12.9	4.39	15.0	5.26	16.1	5.28	17.1	5.73	19.3	6.69	21.4	7.73	
43	10.2	3.75	12.3	4.57	14.6	5.54	15.8	5.61	16.6	5.95	19.0	6.86	20.9	7.93	
44	10.0	3.91	12.2	4.77	14.3	5.84	15.4	5.96	16.4	6.18	18.5	7.04	20.7	8.13	
47	9.5	5.20	11.8	6.35	13.9	6.14	14.9	6.05	15.8	6.57	17.9	7.56	20.0	8.73	
50	8.7	5.11	10.6	6.23	12.4	6.47	13.2	6.55	14.1	7.02	16.0	8.08	18.0	9.13	
52	6.8	3.89	9.2	4.85	11.4	5.45	12.5	5.72	12.6	5.54	12.9	5.46	13.6	5.61	

TC—Total capacity of outdoor unit; PI—Power input of outdoor unit															
Combination	Outdoor air temp (°C DB)	Indoor air temp													
		14.0°C WB		16.0°C WB		18.0°C WB		19.0°C WB		20.0°C WB		22.0°C WB		24.0°C WB	
		20.0°C DB		23.0°C DB		26.0°C DB		27.0°C DB		28.0°C DB		30.0°C DB		32.0°C DB	
		TC	PI	TC	PI	TC	PI	TC	PI	TC	PI	TC	PI	TC	PI
		kW	kW	kW	kW	kW	kW	kW	kW	kW	kW	kW	kW	kW	
50%	-5	9.5	1.27	11.3	1.52	13.2	1.80	14.1	1.94	15.0	2.10	16.9	2.43	18.7	2.78
	0	9.5	1.27	11.3	1.52	13.2	1.80	14.1	1.95	15.0	2.10	16.9	2.44	18.7	2.79
	4	9.5	1.28	11.3	1.53	13.2	1.81	14.1	1.96	15.0	2.11	16.9	2.44	18.7	2.80
	7	9.5	1.30	11.3	1.56	13.2	1.84	14.1	1.99	15.0	2.15	16.9	2.49	18.7	2.85
	10	9.5	1.68	11.3	1.95	13.2	2.23	14.1	2.38	15.0	2.51	16.9	2.83	18.7	3.16
	12	9.5	1.70	11.3	1.97	13.2	2.26	14.1	2.40	15.0	2.57	16.9	2.88	18.7	3.21
	14	9.5	1.72	11.3	2.00	13.2	2.29	14.1	2.45	15.0	2.60	16.9	2.93	18.7	3.27
	16	9.5	1.75	11.3	2.02	13.2	2.33	14.1	2.49	15.0	2.64	16.9	2.98	18.7	3.32
	18	9.5	1.77	11.3	2.06	13.2	2.36	14.1	2.53	15.0	2.69	16.9	3.03	18.7	3.38
	20	9.5	1.80	11.3	2.09	13.2	2.40	14.1	2.58	15.0	2.74	16.9	3.09	18.7	3.45
	21	9.5	1.81	11.3	2.11	13.2	2.43	14.1	2.59	15.0	2.77	16.9	3.12	18.7	3.48
	23	9.5	1.84	11.3	2.14	13.2	2.46	14.1	2.64	15.0	2.82	16.9	3.17	18.7	3.56
	25	9.5	1.86	11.3	2.18	13.2	2.51	14.1	2.69	15.0	2.90	16.9	3.33	18.7	3.80
	27	9.5	1.90	11.3	2.26	13.2	2.65	14.1	2.87	15.0	3.08	16.9	3.55	18.7	4.05
	29	9.5	2.00	11.3	2.39	13.2	2.82	14.1	3.04	15.0	3.28	16.9	3.77	18.7	4.31
	31	9.5	2.11	11.3	2.53	13.2	3.01	14.1	3.23	15.0	3.48	16.9	4.01	18.7	4.59
	33	9.5	2.24	11.3	2.68	13.2	3.17	14.1	3.42	15.0	3.70	16.9	4.26	18.7	4.88
	35	9.5	2.36	11.3	2.83	13.2	3.34	14.1	3.62	15.0	3.91	16.9	4.53	18.7	5.18
	37	9.5	2.49	11.3	2.99	13.2	3.55	13.8	3.84	15.0	4.15	16.9	4.80	18.7	5.51
	39	9.5	2.63	11.3	3.16	13.2	3.75	13.7	4.06	15.0	4.40	16.9	5.09	18.7	5.85
41	9.0	2.98	10.8	3.56	12.5	4.21	13.4	4.20	14.2	4.54	16.1	5.25	17.8	6.01	
43	8.5	3.11	10.2	3.74	12.2	4.44	13.1	4.50	14.0	4.71	15.6	5.39	17.4	6.17	
44	8.4	3.24	10.2	3.88	11.9	4.68	12.8	4.74	13.7	4.89	15.4	5.52	17.2	6.32	
47	7.9	4.31	9.9	5.16	11.5	4.92	12.4	4.82	13.2	5.20	14.9	5.93	16.7	6.79	
50	7.2	4.23	8.8	5.06	10.3	5.18	11.0	5.21	11.7	5.55	13.3	6.34	15.0	7.10	
52	5.7	3.10	7.7	3.86	9.5	4.34	10.4	4.55	10.5	4.40	10.7	4.35	11.3	4.46	

GMV-VQ335WM/C-X

TC—Total capacity of outdoor unit; PI—Power input of outdoor unit															
Combination	Outdoor air temp (°C DB)	Indoor air temp													
		14.0°C WB		16.0°C WB		18.0°C WB		19.0°C WB		20.0°C WB		22.0°C WB		24.0°C WB	
		20.0°C DB		23.0°C DB		26.0°C DB		27.0°C DB		28.0°C DB		30.0°C DB		32.0°C DB	
		TC	PI	TC	PI	TC	PI	TC	PI	TC	PI	TC	PI	TC	PI
		kW	kW	kW	kW	kW	kW	kW	kW	kW	kW	kW	kW	kW	
135%	-5	29.6	5.39	35.3	6.56	41.0	6.64	42.5	6.67	43.3	6.71	44.4	6.79	45.5	6.86
	0	29.6	5.40	35.3	6.57	41.0	6.65	42.5	6.69	43.3	6.72	44.4	6.80	45.5	6.87
	4	29.6	5.42	35.3	6.59	41.0	6.67	42.5	6.71	43.3	6.75	44.4	6.83	45.5	6.90
	7	29.6	5.52	35.3	6.72	41.0	6.80	42.5	6.83	43.3	6.87	44.4	6.95	45.5	7.02
	10	29.6	5.61	35.3	6.86	41.0	8.16	42.5	8.34	43.0	8.17	44.1	7.83	45.2	7.47
	12	29.6	5.24	35.3	6.41	41.0	7.63	41.9	7.60	42.5	7.45	43.5	7.12	44.6	7.02
	14	29.6	5.34	35.3	6.53	40.8	7.72	41.4	7.57	41.9	7.41	43.0	7.35	44.1	7.42
	16	29.6	5.43	35.3	6.67	40.4	7.69	40.8	7.63	41.3	7.66	42.4	7.74	43.5	7.81
	18	29.6	5.54	35.3	6.80	39.8	7.98	40.2	8.02	40.8	8.07	41.9	8.14	43.0	8.22
	20	29.6	5.66	35.3	7.24	39.2	8.37	39.8	8.42	40.2	8.46	41.3	8.54	42.4	8.63
	21	29.6	5.81	35.3	7.50	38.9	8.57	39.5	8.61	40.0	8.66	41.1	8.75	42.2	8.82
	23	29.6	6.23	35.3	8.04	38.4	8.96	38.9	9.00	39.4	9.05	40.5	9.14	41.6	9.23
	25	29.6	6.65	35.3	8.61	37.8	9.35	38.4	9.39	38.9	9.45	40.0	9.54	41.1	9.63
	27	29.6	7.11	35.3	9.21	37.3	8.23	37.8	9.80	38.3	9.85	39.4	9.95	40.5	10.06
	29	29.6	7.59	35.3	9.85	36.7	10.13	37.2	10.19	37.8	10.25	38.9	10.36	40.0	10.46
	31	29.6	8.10	35.2	10.42	36.1	10.54	36.7	10.60	37.2	10.64	38.3	10.76	39.4	10.88
	33	29.6	8.63	34.6	10.81	35.7	10.91	36.1	10.99	36.7	11.05	37.8	11.17	38.8	11.31
	35	29.6	9.20	34.0	11.20	35.1	11.34	35.7	11.40	36.1	11.46	37.2	11.59	38.3	11.71
	37	29.6	9.79	33.5	11.61	34.6	11.74	35.1	11.80	35.7	11.88	36.6	12.01	37.7	12.15
	39	29.6	10.42	32.9	12.00	34.0	12.13	34.6	12.21	35.1	12.28	36.1	12.42	37.2	12.57
41	28.0	11.59	32.3	14.11	33.3	14.28	33.9	13.22	34.4	13.29	35.4	13.45	36.5	13.59	
43	26.5	12.09	31.7	14.71	32.7	15.06	33.2	14.05	33.7	13.79	34.8	13.79	35.8	13.93	
44	26.1	12.60	30.6	15.34	31.7	15.87	32.5	14.93	33.0	14.32	34.1	14.14	35.2	14.29	
47	24.6	16.77	29.6	20.42	30.7	16.66	31.3	15.16	31.8	15.24	32.9	15.18	34.1	15.34	
50	22.5	16.46	26.5	20.05	27.4	17.57	27.9	16.41	28.4	16.27	29.4	16.23	30.7	16.05	
52	14.4	9.74	19.4	12.13	23.9	13.65	26.4	14.33	26.5	13.86	27.1	13.67	28.7	14.04	

GMV6 HR DC Inverter VRF Units Technical Sales Guide

TC—Total capacity of outdoor unit; PI—Power input of outdoor unit															
Combination	Outdoor air temp (°C DB)	Indoor air temp													
		14.0°C WB		16.0°C WB		18.0°C WB		19.0°C WB		20.0°C WB		22.0°C WB		24.0°C WB	
		20.0°C DB		23.0°C DB		26.0°C DB		27.0°C DB		28.0°C DB		30.0°C DB		32.0°C DB	
		TC	PI	TC	PI	TC	PI	TC	PI	TC	PI	TC	PI	TC	PI
		kW	kW	kW	kW	kW	kW	kW	kW	kW	kW	kW	kW	kW	
120%	-5	27.3	4.40	32.5	5.69	37.8	6.05	40.5	6.08	42.6	6.11	43.6	6.18	44.5	6.24
	0	27.3	4.41	32.5	5.70	37.8	6.06	40.5	6.09	42.6	6.12	43.6	6.19	44.5	6.25
	4	27.3	4.42	32.5	5.72	37.8	6.08	40.5	6.11	42.6	6.15	43.6	6.21	44.5	6.28
	7	27.3	4.50	32.5	5.83	37.8	6.19	40.5	6.23	42.6	6.26	43.6	6.33	44.5	6.39
	10	27.3	4.70	32.5	5.74	37.8	6.82	40.5	7.38	42.4	7.69	43.4	7.39	44.3	7.11
	12	27.3	4.79	32.5	5.84	37.8	6.95	40.5	7.51	41.8	7.65	42.8	7.36	43.7	7.06
	14	27.3	4.88	32.5	5.96	37.8	7.09	40.5	7.66	41.2	7.60	42.3	7.32	43.3	7.36
	16	27.3	4.97	32.5	6.08	37.8	7.23	40.2	7.72	40.7	7.62	41.7	7.69	42.7	7.75
	18	27.3	5.06	32.5	6.20	37.8	7.48	39.6	7.98	40.1	8.01	41.1	8.08	42.2	8.16
	20	27.3	5.16	32.5	6.44	37.8	8.04	39.2	8.37	39.6	8.40	40.6	8.48	41.6	8.55
	21	27.3	5.21	32.5	6.67	37.8	8.32	38.8	8.57	39.3	8.60	40.4	8.67	41.3	8.76
	23	27.3	5.57	32.5	7.15	37.8	8.91	38.3	8.94	38.8	8.99	39.8	9.08	40.7	9.15
	25	27.3	5.95	32.5	7.65	37.2	9.30	37.7	9.33	38.2	9.38	39.3	9.47	40.2	9.56
	27	27.3	6.35	32.5	8.17	36.7	9.68	37.2	9.74	37.7	9.79	38.7	9.88	39.6	9.97
	29	27.3	6.77	32.5	8.73	36.1	10.07	36.6	10.13	37.1	10.18	38.1	10.28	39.2	10.37
	31	27.3	7.23	32.5	9.32	35.7	10.48	36.1	10.52	36.6	10.58	37.6	10.69	38.6	10.79
	33	27.3	7.69	32.5	9.95	35.1	10.87	35.5	10.93	36.0	10.97	37.0	11.09	38.0	11.20
	35	27.3	8.19	32.5	10.60	34.5	11.26	34.9	11.32	35.5	11.38	36.5	11.50	37.5	11.62
	37	27.3	8.72	32.5	11.29	34.0	11.67	34.5	11.73	34.9	11.79	35.9	11.91	36.9	12.04
	39	27.3	9.27	32.4	11.92	33.4	12.06	33.9	12.13	34.3	12.19	35.4	12.33	36.4	12.45
41	25.8	10.32	30.9	13.35	32.7	14.19	33.2	13.13	33.8	13.20	34.8	13.34	35.7	13.48	
43	24.4	10.75	29.5	13.92	32.1	14.95	32.6	13.95	33.3	13.70	34.1	13.68	35.0	13.83	
44	24.1	11.22	29.3	14.52	31.2	15.76	31.8	14.83	32.4	14.23	33.4	14.03	34.5	14.18	
47	22.7	14.93	28.3	19.32	30.2	16.55	30.7	15.06	31.3	15.14	32.3	15.07	33.3	15.22	
50	20.8	14.66	25.4	18.97	26.9	17.45	27.4	16.30	27.9	16.16	28.8	16.10	30.0	15.92	
52	14.1	9.68	19.0	12.05	23.5	13.56	25.8	14.24	26.0	13.77	26.6	13.58	28.1	13.95	
110%	-5	25.1	3.89	29.9	5.00	34.7	6.01	37.1	6.04	39.5	6.07	42.6	6.13	43.5	6.18
	0	25.1	3.90	29.9	5.01	34.7	6.02	37.1	6.05	39.5	6.08	42.6	6.14	43.5	6.20
	4	25.1	3.91	29.9	5.03	34.7	6.04	37.1	6.07	39.5	6.10	42.6	6.16	43.5	6.22
	7	25.1	3.98	29.9	5.13	34.7	6.15	37.1	6.18	39.5	6.22	42.6	6.28	43.5	6.33
	10	25.1	4.26	29.9	5.19	34.7	6.17	37.1	6.67	39.5	7.18	42.5	7.62	43.5	7.36
	12	25.1	4.35	29.9	5.30	34.7	6.29	37.1	6.80	39.5	7.32	42.0	7.59	42.9	7.32
	14	25.1	4.43	29.9	5.39	34.7	6.41	37.1	6.92	39.5	7.45	41.4	7.59	42.4	7.30
	16	25.1	4.50	29.9	5.49	34.7	6.53	37.1	7.06	39.5	7.60	41.0	7.63	41.8	7.71
	18	25.1	4.59	29.9	5.60	34.7	6.67	37.1	7.26	39.5	7.96	40.4	8.02	41.3	8.10
	20	25.1	4.68	29.9	5.72	34.7	7.06	37.1	7.80	38.9	8.35	39.9	8.42	40.7	8.49
	21	25.1	4.73	29.9	5.89	34.7	7.32	37.1	8.08	38.7	8.55	39.5	8.61	40.5	8.69
	23	25.1	4.95	29.9	6.31	34.7	7.84	37.1	8.67	38.1	8.93	39.0	9.02	39.9	9.09
	25	25.1	5.27	29.9	6.74	34.7	8.39	37.1	9.29	37.6	9.32	38.4	9.41	39.4	9.48
	27	25.1	5.63	29.9	7.21	34.7	8.97	36.5	9.68	37.0	9.71	38.0	9.80	38.8	9.89
	29	25.1	6.01	29.9	7.69	34.7	9.59	36.0	10.07	36.5	10.12	37.3	10.21	38.3	10.30
	31	25.1	6.40	29.9	8.20	34.7	10.24	35.4	10.46	35.9	10.51	36.9	10.60	37.7	10.70
	33	25.1	6.80	29.9	8.75	34.5	10.79	34.9	10.85	35.4	10.90	36.3	11.00	37.2	11.11
	35	25.1	7.24	29.9	9.32	34.0	11.19	34.3	11.25	34.8	11.31	35.7	11.41	36.6	11.52
	37	25.1	7.71	29.9	9.92	33.4	11.59	33.9	11.64	34.2	11.70	35.2	11.82	36.0	11.92
	39	25.1	8.19	29.9	10.57	32.8	11.98	33.3	12.04	33.7	12.10	34.6	12.22	35.5	12.34
41	23.7	9.12	28.4	11.74	32.3	14.09	32.6	13.04	33.1	13.11	34.0	13.24	34.9	13.36	
43	22.4	9.51	27.0	12.24	31.8	14.85	32.0	13.87	32.5	13.61	33.3	13.57	34.3	13.69	
44	22.1	9.92	26.9	12.77	30.7	15.66	31.2	14.73	31.8	14.13	32.7	13.92	33.7	14.05	
47	20.8	13.20	26.0	16.99	29.7	16.44	30.1	14.96	30.6	15.04	31.6	14.95	32.6	15.09	
50	19.0	12.96	23.3	16.68	26.5	17.34	26.9	16.19	27.3	16.05	28.2	15.98	29.3	15.78	
52	13.9	9.62	18.6	11.97	23.1	13.47	25.4	14.14	25.5	13.68	26.1	13.49	27.6	13.85	

TC—Total capacity of outdoor unit; PI—Power input of outdoor unit															
Combination	Outdoor air temp (°C DB)	Indoor air temp													
		14.0°C WB		16.0°C WB		18.0°C WB		19.0°C WB		20.0°C WB		22.0°C WB		24.0°C WB	
		20.0°C DB		23.0°C DB		26.0°C DB		27.0°C DB		28.0°C DB		30.0°C DB		32.0°C DB	
		TC	PI	TC	PI	TC	PI	TC	PI	TC	PI	TC	PI	TC	PI
		kW	kW	kW	kW	kW	kW	kW	kW	kW	kW	kW	kW	kW	
100%	-5	22.8	3.40	27.1	4.35	31.6	5.43	33.5	6.00	35.9	6.03	40.4	6.08	42.6	6.14
	0	22.8	3.41	27.1	4.36	31.6	5.44	33.5	6.01	35.9	6.04	40.4	6.09	42.6	6.15
	4	22.8	3.42	27.1	4.38	31.6	5.46	33.5	6.03	35.9	6.06	40.4	6.12	42.6	6.17
	7	22.8	3.48	27.1	4.46	31.6	5.56	33.5	6.14	35.9	6.17	40.4	6.23	42.6	6.29
	10	22.8	3.85	27.1	4.68	31.6	5.54	33.5	5.98	35.9	6.46	40.3	7.31	42.6	7.59
	12	22.8	3.90	27.1	4.74	31.6	5.61	33.5	6.06	35.9	6.58	40.3	7.43	42.0	7.53
	14	22.8	3.97	27.1	4.83	31.6	5.71	33.5	6.17	35.9	6.70	40.3	7.56	41.6	7.47
	16	22.8	4.06	27.1	4.93	31.6	5.84	33.5	6.31	35.9	6.85	40.2	7.73	41.0	7.64
	18	22.8	4.15	27.1	5.05	31.6	5.95	33.5	6.43	35.9	6.99	39.6	7.88	40.5	8.00
	20	22.8	4.22	27.1	5.12	31.6	6.15	33.5	6.77	35.9	7.43	39.0	8.30	39.9	8.42
	21	22.8	4.26	27.1	5.17	31.6	6.36	33.5	7.00	35.9	7.69	38.8	8.58	39.6	8.66
	23	22.8	4.37	27.1	5.53	31.6	6.83	33.5	7.53	35.9	8.26	38.3	9.08	39.0	9.16
	25	22.8	4.65	27.1	5.88	31.6	7.27	33.5	8.01	35.9	8.84	37.7	9.41	38.6	9.49
	27	22.8	4.96	27.1	6.28	31.6	7.80	33.5	8.59	35.9	9.48	37.1	9.74	38.0	9.83
	29	22.8	5.26	27.1	6.71	31.6	8.34	33.5	9.19	35.8	10.05	36.6	10.21	37.4	10.30
	31	22.8	5.59	27.1	7.15	31.6	8.89	33.5	9.90	35.3	10.45	35.8	10.62	36.9	10.72
	33	22.8	5.95	27.1	7.61	31.6	9.48	33.5	10.48	34.7	10.83	35.6	10.93	36.4	11.03
	35	22.8	6.33	27.1	8.11	31.6	10.11	33.5	11.17	34.1	11.23	34.9	11.33	35.8	11.43
	37	22.8	6.74	27.1	8.63	31.6	10.77	33.1	11.57	33.7	11.63	34.4	11.71	35.3	11.82
	39	22.8	7.18	27.1	9.20	31.6	11.47	32.7	11.95	32.9	12.01	34.0	12.10	34.4	12.21
41	21.5	7.98	25.8	10.22	30.0	12.74	32.1	12.96	32.4	13.02	33.2	13.14	34.1	13.26	
43	20.3	8.32	24.5	10.66	29.3	13.42	31.5	13.77	32.0	13.52	32.5	13.48	33.7	13.60	
44	20.0	8.67	24.4	11.11	28.6	14.15	30.7	14.63	31.1	14.03	32.0	13.82	32.9	13.94	
47	18.9	11.54	23.6	14.78	27.6	14.86	29.6	14.86	30.0	14.93	30.9	14.84	31.8	14.97	
50	17.3	11.33	21.1	14.51	24.7	15.67	26.4	16.08	26.8	15.94	27.6	15.86	28.6	15.66	
52	13.6	8.75	18.3	10.90	22.7	12.26	24.9	12.87	25.1	12.45	25.7	12.28	27.1	12.61	
90%	-5	20.5	2.97	24.4	3.76	28.4	4.64	30.4	5.12	32.3	5.63	36.3	6.03	40.2	6.08
	0	20.5	2.97	24.4	3.76	28.4	4.64	30.4	5.13	32.3	5.65	36.3	6.04	40.2	6.09
	4	20.5	2.98	24.4	3.78	28.4	4.66	30.4	5.15	32.3	5.67	36.3	6.06	40.2	6.12
	7	20.5	3.04	24.4	3.85	28.4	4.75	30.4	5.25	32.3	5.77	36.3	6.18	40.2	6.23
	10	20.5	3.36	24.4	4.04	28.4	4.73	30.4	5.33	32.3	5.67	36.3	6.50	40.2	7.36
	12	20.5	3.41	24.4	4.09	28.4	4.79	30.4	5.40	32.3	5.78	36.3	6.61	40.2	7.46
	14	20.5	3.47	24.4	4.16	28.4	4.87	30.4	5.48	32.3	5.88	36.3	6.73	40.2	7.58
	16	20.5	3.54	24.4	4.26	28.4	4.98	30.4	5.60	32.3	6.01	36.3	6.88	40.1	7.73
	18	20.5	3.62	24.4	4.35	28.4	5.08	30.4	5.71	32.3	6.13	36.3	7.04	39.7	8.01
	20	20.5	3.68	24.4	4.42	28.4	5.25	30.4	5.83	32.3	6.39	36.3	7.56	39.0	8.34
	21	20.5	3.72	24.4	4.46	28.4	5.43	30.4	6.02	32.3	6.60	36.3	7.82	38.8	8.53
	23	20.5	3.81	24.4	4.77	28.4	5.84	30.4	6.48	32.3	7.07	36.3	8.40	38.2	8.97
	25	20.5	4.05	24.4	5.07	28.4	6.21	30.4	6.91	32.3	7.56	36.3	8.98	37.7	9.33
	27	20.5	4.33	24.4	5.42	28.4	6.66	30.4	7.38	32.3	8.10	36.3	9.59	37.1	9.74
	29	20.5	4.59	24.4	5.79	28.4	7.12	30.4	7.88	32.3	8.64	35.9	10.05	36.6	10.14
	31	20.5	4.88	24.4	6.17	28.4	7.60	30.4	8.41	32.3	9.22	35.3	10.41	36.0	10.55
	33	20.5	5.19	24.4	6.57	28.4	8.10	30.4	8.95	32.3	9.81	34.8	10.83	35.5	10.93
	35	20.5	5.52	24.4	6.99	28.4	8.63	30.4	9.54	32.3	10.49	34.2	11.23	34.9	11.33
	37	20.5	5.88	24.4	7.45	28.4	9.19	29.8	9.88	32.3	11.23	33.6	11.63	34.5	11.60
	39	20.5	6.27	24.4	7.93	28.4	9.79	29.4	10.21	32.3	11.90	33.1	12.06	33.9	12.03
41	19.4	6.96	23.2	8.81	27.0	10.88	28.9	11.07	30.7	12.17	32.6	13.02	33.3	13.14	
43	18.3	7.26	22.0	9.18	26.3	11.47	28.3	11.76	30.1	12.64	32.0	13.36	32.7	13.50	
44	18.0	7.57	22.0	9.58	25.7	12.09	27.6	12.50	29.5	13.12	31.3	13.70	32.1	13.82	
47	17.0	10.07	21.2	12.75	24.9	12.69	26.7	12.69	28.4	13.96	30.3	14.71	31.1	14.84	
50	15.6	9.89	19.0	12.52	22.2	13.38	23.8	13.74	25.4	14.90	27.0	15.72	28.0	15.52	
52	12.3	8.16	16.5	10.16	20.4	11.43	22.4	12.00	22.6	11.61	23.4	11.45	24.4	11.76	

GMV6 HR DC Inverter VRF Units Technical Sales Guide

TC—Total capacity of outdoor unit; PI—Power input of outdoor unit

Combination	Outdoor air temp (°C DB)	Indoor air temp													
		14.0°C WB		16.0°C WB		18.0°C WB		19.0°C WB		20.0°C WB		22.0°C WB		24.0°C WB	
		20.0°C DB		23.0°C DB		26.0°C DB		27.0°C DB		28.0°C DB		30.0°C DB		32.0°C DB	
		TC	PI	TC	PI	TC	PI	TC	PI	TC	PI	TC	PI	TC	PI
		kW	kW	kW	kW	kW	kW	kW	kW	kW	kW	kW	kW	kW	
80%	-5	18.2	2.56	21.7	3.16	25.3	3.93	27.0	4.32	28.7	4.73	32.3	5.61	35.8	6.01
	0	18.2	2.57	21.7	3.17	25.3	3.94	27.0	4.33	28.7	4.74	32.3	5.62	35.8	6.02
	4	18.2	2.58	21.7	3.18	25.3	3.95	27.0	4.35	28.7	4.75	32.3	5.64	35.8	6.05
	7	18.2	2.62	21.7	3.24	25.3	4.02	27.0	4.43	28.7	4.84	32.3	5.75	35.8	6.16
	10	18.2	3.06	21.7	3.66	25.3	4.31	27.0	4.64	28.7	4.96	32.3	5.67	35.8	6.59
	12	18.2	3.10	21.7	3.72	25.3	4.38	27.0	4.73	28.7	5.06	32.3	5.77	35.8	6.53
	14	18.2	3.16	21.7	3.79	25.3	4.46	27.0	4.80	28.7	5.15	32.3	5.87	35.8	6.68
	16	18.2	3.21	21.7	3.85	25.3	4.55	27.0	4.89	28.7	5.23	32.3	6.00	35.8	6.92
	18	18.2	3.27	21.7	3.93	25.3	4.65	27.0	5.00	28.7	5.33	32.3	6.14	35.8	7.40
	20	18.2	3.33	21.7	4.00	25.3	4.73	27.0	5.09	28.7	5.45	32.3	6.36	35.8	7.67
	21	18.2	3.36	21.7	4.03	25.3	4.77	27.0	5.15	28.7	5.58	32.3	6.59	35.8	8.22
	23	18.2	3.42	21.7	4.12	25.3	5.00	27.0	5.48	28.7	5.96	32.3	7.05	35.8	8.79
	25	18.2	3.52	21.7	4.38	25.3	5.34	27.0	5.86	28.7	6.36	32.3	7.55	35.8	9.38
	27	18.2	3.75	21.7	4.67	25.3	5.69	27.0	6.25	28.7	6.83	32.3	8.05	35.8	9.71
	29	18.2	3.99	21.7	4.97	25.3	6.07	27.0	6.65	28.6	7.28	32.3	8.60	35.8	10.06
	31	18.2	4.23	21.7	5.28	25.3	6.46	27.0	7.09	28.6	7.76	32.3	9.17	35.2	10.42
	33	18.2	4.50	21.7	5.89	25.3	6.88	27.0	7.55	28.6	8.27	32.3	9.79	34.7	10.80
	35	18.2	4.77	21.7	5.89	25.3	7.32	27.0	8.05	28.6	8.80	32.3	10.45	34.1	11.19
	37	18.2	5.06	21.7	6.34	25.3	7.78	26.5	8.58	28.6	9.37	32.3	11.13	33.6	11.61
	39	18.2	5.36	21.7	6.73	25.3	8.28	26.1	9.13	28.6	9.98	32.3	11.85	33.0	12.04
41	17.2	6.01	20.6	7.42	24.0	9.22	25.7	9.34	27.2	10.21	30.7	12.12	32.5	12.99	
43	16.3	6.26	20.0	7.74	23.4	9.71	25.2	9.93	26.6	10.60	30.1	12.43	32.0	13.32	
44	16.0	6.54	19.5	8.06	22.9	10.24	24.6	10.55	26.1	11.00	29.6	12.75	31.4	13.66	
47	15.1	8.70	18.9	10.73	22.1	10.75	23.7	10.71	25.2	11.71	28.6	13.69	30.3	14.66	
50	13.8	8.54	16.9	10.54	19.7	11.34	21.1	11.60	22.5	12.50	25.5	14.63	27.3	15.34	
52	10.9	6.89	14.7	8.57	18.1	9.65	20.0	10.13	20.0	9.80	20.5	9.66	21.7	9.92	
70%	-5	15.9	2.18	19.0	2.70	22.1	3.27	23.6	3.59	25.2	3.91	28.2	4.61	31.3	5.36
	0	15.9	2.19	19.0	2.71	22.1	3.28	23.6	3.60	25.2	3.92	28.2	4.62	31.3	5.37
	4	15.9	2.19	19.0	2.72	22.1	3.29	23.6	3.61	25.2	3.93	28.2	4.63	31.3	5.39
	7	15.9	2.24	19.0	2.77	22.1	3.35	23.6	3.68	25.2	4.01	28.2	4.72	31.3	5.49
	10	15.9	2.69	19.0	3.19	22.1	3.72	23.6	4.00	25.1	4.29	28.2	4.88	31.3	5.48
	12	15.9	2.72	19.0	3.24	22.1	3.79	23.6	4.08	25.1	4.37	28.2	4.97	31.3	5.58
	14	15.9	2.77	19.0	3.30	22.1	3.85	23.6	4.14	25.1	4.44	28.2	5.06	31.3	5.69
	16	15.9	2.82	19.0	3.36	22.1	3.93	23.6	4.23	25.1	4.53	28.2	5.15	31.3	5.80
	18	15.9	2.86	19.0	3.42	22.1	4.00	23.6	4.31	25.1	4.61	28.2	5.25	31.3	5.92
	20	15.9	2.91	19.0	3.48	22.1	4.08	23.6	4.38	25.1	4.70	28.2	5.36	31.3	6.08
	21	15.9	2.94	19.0	3.51	22.1	4.11	23.6	4.43	25.1	4.74	28.2	5.42	31.3	6.29
	23	15.9	2.98	19.0	3.57	22.1	4.20	23.6	4.58	25.1	4.98	28.2	5.83	31.3	6.74
	25	15.9	3.04	19.0	3.72	22.1	4.47	23.6	4.89	25.1	5.31	28.2	6.23	31.3	7.21
	27	15.9	3.22	19.0	3.96	22.1	4.77	23.6	5.21	25.1	5.68	28.2	6.65	31.3	7.71
	29	15.9	3.42	19.0	4.20	22.1	5.07	23.6	5.55	25.1	6.04	28.2	7.09	31.3	8.23
	31	15.9	3.61	19.0	4.46	22.1	5.40	23.6	5.90	25.1	6.43	28.2	7.56	31.3	8.78
	33	15.9	3.84	19.0	4.74	22.1	5.75	23.6	6.28	25.1	6.85	28.2	8.05	31.3	9.36
	35	15.9	4.06	19.0	5.03	22.1	6.10	23.6	6.68	25.1	7.29	28.2	8.58	31.3	9.98
	37	15.9	4.29	19.0	5.33	22.1	6.49	23.2	7.11	25.1	7.75	28.2	9.14	31.3	10.63
	39	15.9	4.55	19.0	5.65	22.1	6.88	22.9	7.54	25.1	8.23	28.2	9.71	31.3	11.32
41	15.1	5.12	18.0	6.34	21.0	7.68	22.4	7.75	23.9	8.45	26.9	9.95	29.9	11.58	
43	14.2	5.34	17.5	6.61	20.2	8.10	22.0	8.24	22.7	8.77	26.4	10.20	29.0	11.87	
44	14.0	5.57	17.1	6.89	20.0	8.54	21.5	8.76	22.9	9.11	25.9	10.47	28.8	12.18	
47	13.2	7.41	16.5	9.17	19.3	8.96	20.7	8.89	22.1	9.69	25.0	11.24	27.9	13.07	
50	12.1	7.28	14.8	9.00	17.3	9.45	18.5	9.62	19.7	10.35	22.3	12.01	25.1	13.67	
52	9.5	5.72	12.8	7.12	15.9	7.93	17.5	8.41	17.5	8.13	18.0	8.02	19.0	8.23	

TC—Total capacity of outdoor unit; PI—Power input of outdoor unit															
Combination	Outdoor air temp (°C DB)	Indoor air temp													
		14.0°C WB		16.0°C WB		18.0°C WB		19.0°C WB		20.0°C WB		22.0°C WB		24.0°C WB	
		20.0°C DB		23.0°C DB		26.0°C DB		27.0°C DB		28.0°C DB		30.0°C DB		32.0°C DB	
		TC	PI	TC	PI	TC	PI	TC	PI	TC	PI	TC	PI	TC	PI
		kW	kW	kW	kW	kW	kW	kW	kW	kW	kW	kW	kW	kW	
60%	-5	13.7	1.84	16.3	2.24	18.9	2.68	20.2	2.93	21.6	3.18	24.2	3.71	26.9	4.28
	0	13.7	1.84	16.3	2.24	18.9	2.69	20.2	2.93	21.6	3.18	24.2	3.72	26.9	4.29
	4	13.7	1.85	16.3	2.25	18.9	2.70	20.2	2.94	21.6	3.19	24.2	3.73	26.9	4.31
	7	13.7	1.88	16.3	2.29	18.9	2.75	20.2	3.00	21.6	3.25	24.2	3.80	26.9	4.39
	10	13.7	2.33	16.3	2.74	18.9	3.18	20.2	3.40	21.5	3.63	24.2	4.11	26.9	4.61
	12	13.7	2.38	16.3	2.78	18.9	3.24	20.2	3.46	21.5	3.69	24.2	4.18	26.9	4.68
	14	13.7	2.41	16.3	2.83	18.9	3.28	20.2	3.52	21.5	3.76	24.2	4.26	26.9	4.77
	16	13.7	2.44	16.3	2.88	18.9	3.34	20.2	3.58	21.5	3.82	24.2	4.34	26.9	4.86
	18	13.7	2.48	16.3	2.92	18.9	3.40	20.2	3.64	21.5	3.90	24.2	4.41	26.9	4.95
	20	13.7	2.51	16.3	2.98	18.9	3.46	20.2	3.72	21.5	3.97	24.2	4.50	26.9	5.06
	21	13.7	2.54	16.3	3.00	18.9	3.49	20.2	3.75	21.5	4.00	24.2	4.55	26.9	5.10
	23	13.7	2.57	16.3	3.06	18.9	3.55	20.2	3.82	21.5	4.08	24.2	4.73	26.9	5.43
	25	13.7	2.62	16.3	3.12	18.9	3.69	20.2	4.00	21.5	4.34	24.2	5.04	26.9	5.80
	27	13.7	2.72	16.3	3.30	18.9	3.93	20.2	4.28	21.5	4.62	24.2	5.37	26.9	6.19
	29	13.7	2.88	16.3	3.49	18.9	4.18	20.2	4.55	21.5	4.92	24.2	5.74	26.9	6.61
	31	13.7	3.06	16.3	3.72	18.9	4.44	20.2	4.83	21.5	5.24	24.2	6.10	26.9	7.03
	33	13.7	3.22	16.3	3.93	18.9	4.71	20.2	5.13	21.5	5.57	24.2	6.49	26.9	7.50
	35	13.7	3.42	16.3	4.17	18.9	5.00	20.2	5.45	21.5	5.92	24.2	6.91	26.9	7.98
	37	13.7	3.61	16.3	4.41	18.9	5.30	19.9	5.78	21.5	6.28	24.2	7.35	26.9	8.49
	39	13.7	3.81	16.3	4.67	18.9	5.62	19.6	6.13	21.5	6.67	24.2	7.80	26.9	9.03
41	12.9	4.31	15.5	5.25	18.0	6.30	19.2	6.32	20.5	6.86	23.0	8.02	25.6	9.26	
43	12.2	4.49	14.7	5.47	17.5	6.64	18.9	6.72	19.9	7.12	22.8	8.22	25.1	9.50	
44	12.0	4.68	14.6	5.71	17.1	7.00	18.4	7.14	19.7	7.40	22.2	8.43	24.7	9.73	
47	11.3	6.23	14.2	7.60	16.6	7.35	17.8	7.25	19.0	7.87	21.4	9.05	23.9	10.45	
50	10.4	6.12	12.7	7.46	14.8	7.75	15.8	7.85	16.9	8.40	19.1	9.67	21.5	10.93	
52	8.2	4.66	11.0	5.80	13.6	6.53	15.0	6.85	15.0	6.63	15.4	6.54	16.3	6.71	
50%	-5	11.4	1.52	13.6	1.82	15.8	2.15	16.9	2.33	18.0	2.51	20.2	2.91	22.4	3.33
	0	11.4	1.52	13.6	1.82	15.8	2.15	16.9	2.33	18.0	2.52	20.2	2.92	22.4	3.34
	4	11.4	1.53	13.6	1.83	15.8	2.16	16.9	2.34	18.0	2.53	20.2	2.93	22.4	3.35
	7	11.4	1.56	13.6	1.86	15.8	2.20	16.9	2.38	18.0	2.57	20.2	2.98	22.4	3.41
	10	11.4	2.02	13.6	2.33	15.8	2.66	16.9	2.85	18.0	3.01	20.2	3.39	22.4	3.78
	12	11.4	2.03	13.6	2.36	15.8	2.71	16.9	2.88	18.0	3.07	20.2	3.45	22.4	3.84
	14	11.4	2.06	13.6	2.39	15.8	2.74	16.9	2.94	18.0	3.12	20.2	3.51	22.4	3.91
	16	11.4	2.09	13.6	2.42	15.8	2.78	16.9	2.98	18.0	3.16	20.2	3.57	22.4	3.97
	18	11.4	2.12	13.6	2.47	15.8	2.83	16.9	3.03	18.0	3.22	20.2	3.63	22.4	4.05
	20	11.4	2.15	13.6	2.50	15.8	2.88	16.9	3.09	18.0	3.28	20.2	3.70	22.4	4.12
	21	11.4	2.17	13.6	2.53	15.8	2.91	16.9	3.10	18.0	3.31	20.2	3.73	22.4	4.17
	23	11.4	2.20	13.6	2.56	15.8	2.95	16.9	3.16	18.0	3.37	20.2	3.79	22.4	4.26
	25	11.4	2.23	13.6	2.60	15.8	3.01	16.9	3.22	18.0	3.48	20.2	3.99	22.4	4.55
	27	11.4	2.27	13.6	2.71	15.8	3.18	16.9	3.43	18.0	3.69	20.2	4.25	22.4	4.85
	29	11.4	2.39	13.6	2.86	15.8	3.37	16.9	3.64	17.9	3.93	20.2	4.52	22.4	5.16
	31	11.4	2.53	13.6	3.03	15.8	3.60	16.9	3.87	17.9	4.17	20.2	4.80	22.4	5.49
	33	11.4	2.68	13.6	3.21	15.8	3.79	16.9	4.09	17.9	4.43	20.2	5.10	22.4	5.84
	35	11.4	2.83	13.6	3.39	15.8	4.00	16.9	4.34	17.9	4.68	20.2	5.42	22.4	6.20
	37	11.4	2.98	13.6	3.58	15.8	4.25	16.6	4.59	17.9	4.97	20.2	5.75	22.4	6.59
	39	11.4	3.15	13.6	3.78	15.8	4.49	16.3	4.86	17.9	5.27	20.2	6.10	22.4	7.00
41	10.8	3.57	12.9	4.27	15.0	5.05	16.0	5.03	17.0	5.43	19.2	6.29	21.4	7.19	
43	10.2	3.72	12.2	4.48	14.6	5.31	15.7	5.39	16.7	5.64	18.7	6.45	20.8	7.38	
44	10.0	3.88	12.2	4.64	14.3	5.61	15.3	5.68	16.3	5.85	18.5	6.61	20.6	7.57	
47	9.4	5.16	11.8	6.17	13.8	5.89	14.8	5.77	15.7	6.23	17.9	7.10	19.9	8.12	
50	8.7	5.07	10.6	6.06	12.3	6.21	13.2	6.24	14.0	6.65	15.9	7.59	17.9	8.50	
52	6.8	3.71	9.2	4.62	11.3	5.19	12.5	5.45	12.5	5.27	12.8	5.20	13.6	5.34	

GMV6 HR DC Inverter VRF Units Technical Sales Guide

GMV-VQ400WM/C-X

TC—Total capacity of outdoor unit; PI—Power input of outdoor unit

Combination	Outdoor air temp (°C DB)	Indoor air temp													
		14.0°C WB		16.0°C WB		18.0°C WB		19.0°C WB		20.0°C WB		22.0°C WB		24.0°C WB	
		20.0°C DB		23.0°C DB		26.0°C DB		27.0°C DB		28.0°C DB		30.0°C DB		32.0°C DB	
		TC	PI	TC	PI	TC	PI	TC	PI	TC	PI	TC	PI	TC	PI
		kW	kW	kW	kW	kW	kW	kW	kW	kW	kW	kW	kW	kW	
135%	-5	35.4	6.36	42.1	7.75	48.9	7.84	50.8	7.88	51.7	7.93	53.0	8.02	54.3	8.10
	0	35.4	6.38	42.1	7.76	48.9	7.86	50.8	7.90	51.7	7.94	53.0	8.03	54.3	8.12
	4	35.4	6.40	42.1	7.79	48.9	7.89	50.8	7.93	51.7	7.97	53.0	8.06	54.3	8.15
	7	35.4	6.52	42.1	7.94	48.9	8.03	50.8	8.07	51.7	8.12	53.0	8.21	54.3	8.30
	10	35.4	6.63	42.2	8.11	48.9	9.64	50.8	9.85	51.4	9.66	52.7	9.25	53.9	8.82
	12	35.4	6.75	42.2	8.26	48.9	9.83	50.1	9.79	50.8	9.60	51.9	9.17	53.2	9.04
	14	35.4	6.88	42.2	8.42	48.8	9.95	49.5	9.75	50.1	9.54	51.4	9.46	52.7	9.56
	16	35.4	7.00	42.2	8.59	48.2	9.91	48.8	9.83	49.3	9.87	50.6	9.97	51.9	10.07
	18	35.4	7.14	42.2	8.77	47.5	10.28	48.0	10.34	48.8	10.39	50.1	10.49	51.4	10.59
	20	35.4	7.29	42.2	9.33	46.8	10.78	47.5	10.84	48.0	10.90	49.3	11.00	50.6	11.11
	21	35.4	7.49	42.2	9.66	46.5	11.03	47.2	11.09	47.8	11.15	49.1	11.27	50.4	11.36
	23	35.4	8.03	42.2	10.36	45.9	11.54	46.5	11.60	47.0	11.66	48.3	11.77	49.6	11.89
	25	35.4	8.57	42.2	11.09	45.2	12.04	45.9	12.10	46.5	12.18	47.8	12.30	49.1	12.41
	27	35.4	9.15	42.2	11.87	44.6	10.61	45.2	12.63	45.7	12.68	47.0	12.82	48.3	12.95
	29	35.4	9.77	42.2	12.68	43.9	13.05	44.5	13.13	45.2	13.21	46.5	13.34	47.8	13.48
	31	35.4	10.43	42.0	13.42	43.2	13.58	43.9	13.65	44.5	13.71	45.7	13.87	47.0	14.02
	33	35.4	11.11	41.3	13.92	42.6	14.06	43.2	14.16	43.9	14.23	45.2	14.39	46.3	14.56
	35	35.4	11.85	40.6	14.43	41.9	14.60	42.6	14.68	43.2	14.76	44.5	14.93	45.7	15.09
	37	35.4	12.61	40.0	14.95	41.3	15.13	41.9	15.20	42.6	15.30	43.7	15.48	45.0	15.65
	39	35.4	13.42	39.3	15.46	40.6	15.63	41.3	15.73	41.9	15.83	43.2	16.00	44.5	16.19
41	33.4	14.93	38.5	18.18	39.8	18.40	40.5	17.03	41.0	17.12	42.3	17.32	43.6	17.50	
43	31.6	15.57	37.8	18.95	39.0	19.40	39.7	18.10	40.2	17.77	41.5	17.76	42.8	17.94	
44	31.1	16.23	36.5	19.77	37.9	20.44	38.7	19.23	39.4	18.45	40.7	18.22	42.1	18.41	
47	29.4	21.60	35.3	26.30	36.6	21.47	37.4	19.53	38.0	19.63	39.3	19.56	40.7	19.77	
50	26.9	21.21	31.6	25.83	32.7	22.64	33.3	21.14	33.9	20.96	35.1	20.91	36.6	20.67	
52	17.2	12.55	23.1	15.63	28.6	17.59	31.5	18.46	31.6	17.86	32.4	17.61	34.2	18.09	
120%	-5	32.7	5.67	38.8	7.33	45.2	7.79	48.3	7.83	50.8	7.87	52.0	7.96	53.2	8.04
	0	32.7	5.68	38.8	7.35	45.2	7.80	48.3	7.85	50.8	7.89	52.0	7.97	53.2	8.05
	4	32.7	5.70	38.8	7.37	45.2	7.83	48.3	7.88	50.8	7.92	52.0	8.00	53.2	8.08
	7	32.7	5.80	38.8	7.51	45.2	7.98	48.3	8.02	50.8	8.06	52.0	8.15	53.2	8.23
	10	32.7	6.05	38.8	7.39	45.2	8.79	48.3	9.50	50.6	9.91	51.8	9.52	52.9	9.15
	12	32.7	6.17	38.8	7.52	45.2	8.96	48.3	9.68	49.9	9.85	51.1	9.48	52.2	9.10
	14	32.7	6.28	38.8	7.68	45.2	9.13	48.3	9.87	49.2	9.79	50.5	9.43	51.6	9.48
	16	32.7	6.40	38.8	7.83	45.2	9.31	48.0	9.95	48.6	9.81	49.8	9.91	50.9	9.99
	18	32.7	6.52	38.8	7.99	45.2	9.64	47.3	10.28	47.9	10.32	49.1	10.41	50.4	10.51
	20	32.7	6.65	38.8	8.30	45.2	10.36	46.8	10.78	47.3	10.82	48.5	10.92	49.6	11.02
	21	32.7	6.71	38.8	8.59	45.2	10.72	46.3	11.03	46.9	11.07	48.2	11.17	49.3	11.29
	23	32.7	7.18	38.8	9.21	45.2	11.48	45.7	11.52	46.3	11.58	47.5	11.69	48.6	11.79
	25	32.7	7.66	38.8	9.85	44.5	11.99	45.0	12.02	45.6	12.08	46.9	12.20	48.0	12.31
	27	32.7	8.18	38.8	10.53	43.9	12.47	44.5	12.55	45.0	12.61	46.2	12.72	47.3	12.84
	29	32.7	8.73	38.8	11.25	43.2	12.97	43.7	13.05	44.3	13.11	45.5	13.25	46.8	13.36
	31	32.7	9.31	38.8	12.00	42.6	13.50	43.2	13.56	43.7	13.63	44.9	13.77	46.0	13.91
	33	32.7	9.91	38.8	12.82	41.9	14.00	42.4	14.08	43.0	14.14	44.2	14.29	45.3	14.43
	35	32.7	10.55	38.8	13.65	41.1	14.51	41.7	14.58	42.4	14.66	43.6	14.82	44.7	14.97
	37	32.7	11.23	38.8	14.55	40.6	15.03	41.1	15.11	41.7	15.19	42.9	15.34	44.0	15.51
	39	32.7	11.95	38.7	15.36	39.8	15.53	40.4	15.63	41.0	15.71	42.3	15.88	43.4	16.04
41	30.9	13.29	36.9	17.20	39.1	18.28	39.7	16.92	40.4	17.01	41.5	17.19	42.6	17.37	
43	29.2	13.85	35.2	17.93	38.4	19.26	38.9	17.97	39.7	17.66	40.7	17.62	41.8	17.82	
44	28.7	14.45	35.0	18.70	37.2	20.31	38.0	19.10	38.7	18.33	39.9	18.08	41.2	18.27	
47	27.1	19.23	33.8	24.89	36.0	21.32	36.6	19.40	37.3	19.50	38.6	19.41	39.8	19.61	
50	24.8	18.88	30.3	24.44	32.1	22.48	32.7	21.00	33.3	20.82	34.4	20.74	35.8	20.51	
52	16.8	12.47	22.6	15.53	28.0	17.47	30.8	18.34	31.0	17.74	31.7	17.50	33.5	17.97	

TC—Total capacity of outdoor unit; PI—Power input of outdoor unit															
Combination	Outdoor air temp (°C DB)	Indoor air temp													
		14.0°C WB		16.0°C WB		18.0°C WB		19.0°C WB		20.0°C WB		22.0°C WB		24.0°C WB	
		20.0°C DB		23.0°C DB		26.0°C DB		27.0°C DB		28.0°C DB		30.0°C DB		32.0°C DB	
		TC	PI	TC	PI	TC	PI	TC	PI	TC	PI	TC	PI	TC	PI
		kW	kW	kW	kW	kW	kW	kW	kW	kW	kW	kW	kW	kW	
110%	-5	29.9	5.01	35.7	6.45	41.4	7.74	44.3	7.78	47.2	7.82	50.8	7.89	51.9	7.97
	0	29.9	5.02	35.7	6.46	41.4	7.75	44.3	7.79	47.2	7.84	50.8	7.91	51.9	7.98
	4	29.9	5.04	35.7	6.48	41.4	7.78	44.3	7.82	47.2	7.86	50.8	7.94	51.9	8.01
	7	29.9	5.13	35.7	6.60	41.4	7.93	44.3	7.97	47.2	8.01	50.8	8.09	51.9	8.16
	10	29.9	5.49	35.7	6.69	41.4	7.95	44.3	8.59	47.2	9.25	50.8	9.81	51.9	9.48
	12	29.9	5.60	35.7	6.83	41.4	8.11	44.3	8.77	47.2	9.43	50.2	9.77	51.2	9.43
	14	29.9	5.70	35.7	6.94	41.4	8.26	44.3	8.92	47.2	9.60	49.5	9.77	50.6	9.41
	16	29.9	5.80	35.7	7.08	41.4	8.42	44.3	9.10	47.2	9.79	48.9	9.83	49.9	9.93
	18	29.9	5.92	35.7	7.21	41.4	8.59	44.3	9.35	47.2	10.26	48.2	10.34	49.3	10.43
	20	29.9	6.03	35.7	7.37	41.4	9.10	44.3	10.05	46.5	10.76	47.6	10.84	48.6	10.94
	21	29.9	6.09	35.7	7.58	41.4	9.43	44.3	10.41	46.2	11.02	47.2	11.09	48.3	11.19
	23	29.9	6.38	35.7	8.13	41.4	10.10	44.3	11.17	45.5	11.50	46.6	11.62	47.6	11.71
	25	29.9	6.79	35.7	8.69	41.4	10.80	44.3	11.97	44.9	12.00	45.9	12.12	47.0	12.22
	27	29.9	7.25	35.7	9.29	41.4	11.56	43.6	12.47	44.2	12.51	45.3	12.63	46.3	12.74
	29	29.9	7.74	35.7	9.91	41.4	12.35	43.0	12.97	43.6	13.03	44.6	13.15	45.7	13.27
	31	29.9	8.24	35.7	10.57	41.4	13.19	42.3	13.48	42.9	13.54	44.0	13.65	45.0	13.79
	33	29.9	8.77	35.7	11.27	41.1	13.91	41.7	13.98	42.3	14.04	43.3	14.18	44.5	14.31
	35	29.9	9.33	35.7	12.00	40.6	14.41	41.0	14.49	41.6	14.56	42.6	14.70	43.7	14.84
	37	29.9	9.93	35.7	12.78	39.8	14.93	40.4	14.99	40.9	15.07	42.0	15.22	43.0	15.36
	39	29.9	10.55	35.7	13.61	39.1	15.44	39.7	15.51	40.3	15.59	41.3	15.75	42.4	15.90
41	28.3	11.75	33.9	15.13	38.5	18.16	39.0	16.80	39.5	16.89	40.5	17.05	41.7	17.21	
43	26.7	12.26	32.2	15.77	38.0	19.13	38.2	17.87	38.8	17.54	39.8	17.49	40.9	17.64	
44	26.3	12.78	32.1	16.45	36.7	20.17	37.3	18.98	38.0	18.21	39.0	17.93	40.2	18.10	
47	24.8	17.01	31.0	21.88	35.5	21.18	36.0	19.27	36.6	19.37	37.7	19.26	38.9	19.44	
50	22.7	16.70	27.8	21.49	31.7	22.33	32.1	20.86	32.6	20.68	33.6	20.58	35.0	20.33	
52	16.5	12.39	22.3	15.42	27.5	17.35	30.3	18.22	30.5	17.62	31.2	17.38	32.9	17.85	
100%	-5	27.2	4.38	32.4	5.61	37.7	6.99	40.0	7.73	42.9	7.77	48.2	7.84	50.9	7.91
	0	27.2	4.39	32.4	5.62	37.7	7.01	40.0	7.74	42.9	7.78	48.2	7.85	50.9	7.92
	4	27.2	4.40	32.4	5.64	37.7	7.03	40.0	7.77	42.9	7.81	48.2	7.88	50.9	7.95
	7	27.2	4.49	32.4	5.74	37.7	7.16	40.0	7.91	42.9	7.95	48.2	8.03	50.9	8.10
	10	27.2	4.96	32.4	6.03	37.7	7.13	40.0	7.70	42.9	8.32	48.2	9.41	50.9	9.78
	12	27.2	5.03	32.4	6.11	37.7	7.23	40.0	7.80	42.9	8.48	48.2	9.58	50.2	9.71
	14	27.2	5.12	32.4	6.22	37.7	7.35	40.0	7.95	42.9	8.63	48.2	9.74	49.6	9.63
	16	27.2	5.23	32.4	6.36	37.7	7.52	40.0	8.13	42.9	8.83	48.0	9.96	48.9	9.85
	18	27.2	5.35	32.4	6.50	37.7	7.66	40.0	8.28	42.9	9.00	47.3	10.15	48.3	10.31
	20	27.2	5.43	32.4	6.60	37.7	7.92	40.0	8.72	42.9	9.57	46.6	10.69	47.6	10.85
	21	27.2	5.49	32.4	6.67	37.7	8.19	40.0	9.02	42.9	9.90	46.3	11.05	47.3	11.15
	23	27.2	5.63	32.4	7.12	37.7	8.80	40.0	9.70	42.9	10.65	45.8	11.70	46.6	11.80
	25	27.2	5.99	32.4	7.58	37.7	9.37	40.0	10.32	42.9	11.39	45.0	12.12	46.0	12.23
	27	27.2	6.40	32.4	8.09	37.7	10.05	40.0	11.07	42.9	12.22	44.3	12.55	45.3	12.66
	29	27.2	6.78	32.4	8.65	37.7	10.75	40.0	11.84	42.7	12.94	43.7	13.15	44.7	13.27
	31	27.2	7.21	32.4	9.21	37.7	11.46	40.0	12.76	42.2	13.47	42.7	13.69	44.0	13.81
	33	27.2	7.67	32.4	9.81	37.7	12.22	40.0	13.50	41.4	13.96	42.5	14.08	43.4	14.21
	35	27.2	8.16	32.4	10.44	37.7	13.02	40.0	14.39	40.7	14.46	41.7	14.59	42.7	14.72
	37	27.2	8.69	32.4	11.12	37.7	13.87	39.6	14.91	40.2	14.98	41.1	15.09	42.1	15.22
	39	27.2	9.25	32.4	11.85	37.7	14.77	39.0	15.40	39.2	15.48	40.6	15.59	41.1	15.73
41	25.7	10.28	30.7	13.16	35.8	16.41	38.3	16.69	38.7	16.78	39.7	16.93	40.7	17.08	
43	24.3	10.72	29.2	13.73	35.0	17.29	37.6	17.74	38.2	17.41	38.8	17.36	40.3	17.52	
44	23.9	11.18	29.1	14.31	34.1	18.23	36.7	18.85	37.2	18.08	38.2	17.80	39.3	17.96	
47	22.6	14.87	28.2	19.04	33.0	19.14	35.4	19.14	35.8	19.23	36.9	19.12	38.0	19.29	
50	20.7	14.60	25.2	18.70	29.4	20.19	31.5	20.72	32.0	20.54	32.9	20.43	34.2	20.17	
52	16.3	11.28	21.9	14.04	27.0	15.80	29.8	16.59	29.9	16.04	30.6	15.82	32.4	16.25	

GMV6 HR DC Inverter VRF Units Technical Sales Guide

TC—Total capacity of outdoor unit; PI—Power input of outdoor unit

Combination	Outdoor air temp (°C DB)	Indoor air temp													
		14.0°C WB		16.0°C WB		18.0°C WB		19.0°C WB		20.0°C WB		22.0°C WB		24.0°C WB	
		20.0°C DB		23.0°C DB		26.0°C DB		27.0°C DB		28.0°C DB		30.0°C DB		32.0°C DB	
		TC	PI	TC	PI	TC	PI	TC	PI	TC	PI	TC	PI	TC	PI
		kW	kW	kW	kW	kW	kW	kW	kW	kW	kW	kW	kW	kW	
90%	-5	24.5	3.82	29.1	4.84	33.9	5.97	36.3	6.60	38.6	7.26	43.3	7.77	48.0	7.84
	0	24.5	3.83	29.1	4.85	33.9	5.98	36.3	6.61	38.6	7.27	43.3	7.78	48.0	7.85
	4	24.5	3.84	29.1	4.86	33.9	6.01	36.3	6.64	38.6	7.30	43.3	7.81	48.0	7.88
	7	24.5	3.91	29.1	4.95	33.9	6.12	36.3	6.76	38.6	7.43	43.3	7.96	48.0	8.03
	10	24.5	4.33	29.1	5.20	33.9	6.09	36.3	6.86	38.6	7.31	43.4	8.37	48.0	9.49
	12	24.5	4.39	29.1	5.27	33.9	6.17	36.3	6.95	38.6	7.45	43.4	8.52	48.0	9.61
	14	24.5	4.46	29.1	5.36	33.9	6.28	36.3	7.06	38.6	7.58	43.4	8.66	48.0	9.77
	16	24.5	4.57	29.1	5.48	33.9	6.42	36.3	7.22	38.6	7.75	43.4	8.86	47.9	9.96
	18	24.5	4.67	29.1	5.61	33.9	6.55	36.3	7.36	38.6	7.90	43.4	9.07	47.5	10.32
	20	24.5	4.74	29.1	5.69	33.9	6.76	36.3	7.51	38.6	8.23	43.4	9.74	46.6	10.75
	21	24.5	4.79	29.1	5.75	33.9	6.99	36.3	7.76	38.6	8.51	43.4	10.07	46.3	10.99
	23	24.5	4.91	29.1	6.14	33.9	7.52	36.3	8.34	38.6	9.11	43.4	10.82	45.6	11.56
	25	24.5	5.22	29.1	6.53	33.9	8.00	36.3	8.90	38.6	9.74	43.4	11.57	45.0	12.02
	27	24.5	5.58	29.1	6.98	33.9	8.58	36.3	9.50	38.6	10.43	43.4	12.35	44.3	12.55
	29	24.5	5.91	29.1	7.46	33.9	9.18	36.3	10.15	38.6	11.13	42.9	12.94	43.7	13.06
	31	24.5	6.29	29.1	7.94	33.9	9.79	36.3	10.84	38.6	11.88	42.2	13.41	43.0	13.59
	33	24.5	6.69	29.1	8.46	33.9	10.43	36.3	11.53	38.6	12.64	41.6	13.96	42.4	14.08
	35	24.5	7.12	29.1	9.01	33.9	11.12	36.3	12.29	38.6	13.52	40.9	14.46	41.7	14.59
	37	24.5	7.58	29.1	9.59	33.9	11.84	35.6	12.73	38.6	14.46	40.1	14.98	41.1	14.94
	39	24.5	8.07	29.1	10.22	33.9	12.61	35.1	13.15	38.6	15.33	39.6	15.54	40.4	15.50
41	23.1	8.97	27.7	11.35	32.2	14.01	34.5	14.26	36.7	15.68	38.9	16.78	39.8	16.93	
43	21.9	9.35	26.3	11.83	31.4	14.78	33.8	15.15	36.0	16.28	38.2	17.21	39.1	17.39	
44	21.5	9.75	26.2	12.34	30.7	15.57	33.0	16.10	35.2	16.90	37.4	17.65	38.4	17.81	
47	20.3	12.97	25.3	16.42	29.7	16.35	31.8	16.34	33.9	17.98	36.2	18.95	37.1	19.12	
50	18.6	12.74	22.7	16.13	26.5	17.24	28.4	17.70	30.3	19.20	32.3	20.25	33.4	19.99	
52	14.6	10.51	19.7	13.09	24.3	14.73	26.8	15.46	26.9	14.95	27.9	14.75	29.1	15.15	
80%	-5	21.8	3.30	25.9	4.07	30.2	5.06	32.2	5.57	34.2	6.09	38.6	7.23	42.7	7.74
	0	21.8	3.31	25.9	4.08	30.2	5.07	32.2	5.58	34.2	6.10	38.6	7.24	42.7	7.76
	4	21.8	3.32	25.9	4.09	30.2	5.09	32.2	5.60	34.2	6.12	38.6	7.27	42.7	7.79
	7	21.8	3.38	25.9	4.17	30.2	5.18	32.2	5.71	34.2	6.24	38.6	7.40	42.7	7.93
	10	21.8	3.94	25.9	4.71	30.2	5.55	32.2	5.97	34.3	6.40	38.5	7.31	42.7	8.49
	12	21.8	4.00	25.9	4.79	30.2	5.64	32.2	6.09	34.3	6.52	38.5	7.43	42.7	8.42
	14	21.8	4.07	25.9	4.89	30.2	5.74	32.2	6.19	34.3	6.64	38.5	7.56	42.7	8.61
	16	21.8	4.13	25.9	4.96	30.2	5.86	32.2	6.30	34.3	6.74	38.5	7.73	42.7	8.92
	18	21.8	4.21	25.9	5.06	30.2	5.99	32.2	6.44	34.3	6.87	38.5	7.91	42.7	9.54
	20	21.8	4.29	25.9	5.16	30.2	6.09	32.2	6.56	34.3	7.03	38.5	8.19	42.7	9.89
	21	21.8	4.32	25.9	5.20	30.2	6.15	32.2	6.63	34.3	7.18	38.5	8.49	42.7	10.58
	23	21.8	4.40	25.9	5.31	30.2	6.44	32.2	7.06	34.3	7.68	38.5	9.08	42.7	11.32
	25	21.8	4.54	25.9	5.64	30.2	6.88	32.2	7.54	34.3	8.20	38.5	9.72	42.7	12.08
	27	21.8	4.83	25.9	6.01	30.2	7.33	32.2	8.05	34.3	8.80	38.5	10.38	42.7	12.51
	29	21.8	5.14	25.9	6.40	30.2	7.82	32.2	8.57	34.2	9.38	38.5	11.07	42.7	12.96
	31	21.8	5.45	25.9	6.81	30.2	8.32	32.2	9.13	34.2	10.00	38.5	11.82	42.0	13.43
	33	21.8	5.80	25.9	7.58	30.2	8.86	32.2	9.73	34.2	10.65	38.5	12.61	41.4	13.92
	35	21.8	6.15	25.9	7.58	30.2	9.43	32.2	10.38	34.2	11.34	38.5	13.46	40.7	14.42
	37	21.8	6.52	25.9	8.16	30.2	10.03	31.6	11.05	34.2	12.08	38.5	14.34	40.1	14.96
	39	21.8	6.90	25.9	8.67	30.2	10.67	31.2	11.77	34.2	12.86	38.5	15.27	39.4	15.51
41	20.6	7.75	24.6	9.55	28.7	11.88	30.6	12.04	32.5	13.15	36.7	15.61	38.8	16.73	
43	19.4	8.07	23.9	9.97	27.9	12.51	30.1	12.80	31.8	13.65	36.0	16.01	38.2	17.16	
44	19.1	8.42	23.3	10.39	27.3	13.20	29.3	13.59	31.2	14.18	35.3	16.42	37.5	17.59	
47	18.1	11.21	22.5	13.82	26.4	13.86	28.3	13.80	30.1	15.08	34.1	17.63	36.2	18.89	
50	16.5	11.00	20.2	13.57	23.5	14.61	25.2	14.94	26.8	16.10	30.4	18.84	32.6	19.76	
52	13.0	8.87	17.5	11.05	21.6	12.43	23.8	13.05	23.9	12.62	24.5	12.45	25.9	12.78	

TC—Total capacity of outdoor unit; PI—Power input of outdoor unit															
Combination	Outdoor air temp (°C DB)	Indoor air temp													
		14.0°C WB		16.0°C WB		18.0°C WB		19.0°C WB		20.0°C WB		22.0°C WB		24.0°C WB	
		20.0°C DB		23.0°C DB		26.0°C DB		27.0°C DB		28.0°C DB		30.0°C DB		32.0°C DB	
		TC	PI	TC	PI	TC	PI	TC	PI	TC	PI	TC	PI	TC	PI
		kW	kW	kW	kW	kW	kW	kW	kW	kW	kW	kW	kW	kW	
70%	-5	19.0	2.81	22.7	3.48	26.4	4.22	28.2	4.62	30.1	5.04	33.7	5.94	37.4	6.90
	0	19.0	2.82	22.7	3.48	26.4	4.23	28.2	4.63	30.1	5.05	33.7	5.95	37.4	6.92
	4	19.0	2.83	22.7	3.50	26.4	4.24	28.2	4.65	30.1	5.07	33.7	5.97	37.4	6.94
	7	19.0	2.88	22.7	3.56	26.4	4.32	28.2	4.74	30.1	5.16	33.7	6.08	37.4	7.07
	10	19.0	3.47	22.7	4.11	26.4	4.79	28.2	5.16	30.0	5.53	33.7	6.28	37.4	7.06
	12	19.0	3.51	22.7	4.17	26.4	4.89	28.2	5.26	30.0	5.62	33.7	6.40	37.4	7.20
	14	19.0	3.57	22.7	4.25	26.4	4.96	28.2	5.33	30.0	5.72	33.7	6.52	37.4	7.33
	16	19.0	3.63	22.7	4.32	26.4	5.06	28.2	5.45	30.0	5.84	33.7	6.63	37.4	7.47
	18	19.0	3.68	22.7	4.40	26.4	5.16	28.2	5.55	30.0	5.93	33.7	6.77	37.4	7.62
	20	19.0	3.74	22.7	4.48	26.4	5.26	28.2	5.64	30.0	6.05	33.7	6.90	37.4	7.83
	21	19.0	3.78	22.7	4.52	26.4	5.29	28.2	5.70	30.0	6.11	33.7	6.98	37.4	8.11
	23	19.0	3.84	22.7	4.60	26.4	5.41	28.2	5.90	30.0	6.42	33.7	7.51	37.4	8.69
	25	19.0	3.92	22.7	4.79	26.4	5.76	28.2	6.30	30.0	6.85	33.7	8.03	37.4	9.29
	27	19.0	4.15	22.7	5.10	26.4	6.15	28.2	6.71	30.0	7.31	33.7	8.57	37.4	9.93
	29	19.0	4.40	22.7	5.41	26.4	6.54	28.2	7.16	30.0	7.78	33.7	9.13	37.4	10.61
	31	19.0	4.65	22.7	5.74	26.4	6.96	28.2	7.60	30.0	8.28	33.7	9.74	37.4	11.31
	33	19.0	4.95	22.7	6.11	26.4	7.41	28.2	8.09	30.0	8.82	33.7	10.38	37.4	12.06
	35	19.0	5.24	22.7	6.48	26.4	7.85	28.2	8.61	30.0	9.39	33.7	11.05	37.4	12.86
	37	19.0	5.53	22.7	6.87	26.4	8.36	27.7	9.15	30.0	9.99	33.7	11.77	37.4	13.69
	39	19.0	5.86	22.7	7.27	26.4	8.86	27.3	9.72	30.0	10.61	33.7	12.51	37.4	14.58
41	18.0	6.60	21.5	8.16	25.1	9.90	26.8	9.99	28.5	10.89	32.1	12.82	35.6	14.92	
43	17.0	6.88	20.9	8.52	24.2	10.43	26.3	10.62	27.1	11.30	31.5	13.14	34.7	15.30	
44	16.7	7.17	20.4	8.87	23.9	11.00	25.7	11.28	27.4	11.73	30.9	13.49	34.4	15.69	
47	15.8	9.55	19.7	11.81	23.1	11.55	24.8	11.45	26.4	12.48	29.8	14.48	33.3	16.84	
50	14.5	9.37	17.7	11.59	20.6	12.17	22.1	12.40	23.6	13.33	26.6	15.48	29.9	17.62	
52	11.4	7.36	15.3	9.17	18.9	10.22	20.8	10.83	20.9	10.47	21.4	10.33	22.7	10.61	
60%	-5	16.3	2.36	19.4	2.88	22.6	3.46	24.2	3.77	25.8	4.09	28.9	4.78	32.1	5.52
	0	16.3	2.37	19.4	2.89	22.6	3.46	24.2	3.78	25.8	4.10	28.9	4.79	32.1	5.53
	4	16.3	2.38	19.4	2.90	22.6	3.48	24.2	3.79	25.8	4.12	28.9	4.81	32.1	5.55
	7	16.3	2.42	19.4	2.95	22.6	3.54	24.2	3.86	25.8	4.19	28.9	4.90	32.1	5.65
	10	16.3	3.01	19.4	3.53	22.6	4.09	24.2	4.38	25.7	4.67	28.9	5.29	32.1	5.93
	12	16.3	3.06	19.4	3.59	22.6	4.17	24.2	4.46	25.7	4.75	28.9	5.39	32.1	6.03
	14	16.3	3.10	19.4	3.65	22.6	4.23	24.2	4.54	25.7	4.85	28.9	5.49	32.1	6.15
	16	16.3	3.14	19.4	3.70	22.6	4.31	24.2	4.62	25.7	4.93	28.9	5.59	32.1	6.26
	18	16.3	3.20	19.4	3.76	22.6	4.38	24.2	4.69	25.7	5.02	28.9	5.68	32.1	6.38
	20	16.3	3.24	19.4	3.84	22.6	4.46	24.2	4.79	25.7	5.12	28.9	5.80	32.1	6.52
	21	16.3	3.28	19.4	3.86	22.6	4.50	24.2	4.83	25.7	5.16	28.9	5.86	32.1	6.57
	23	16.3	3.32	19.4	3.94	22.6	4.58	24.2	4.93	25.7	5.26	28.9	6.09	32.1	7.00
	25	16.3	3.37	19.4	4.01	22.6	4.75	24.2	5.16	25.7	5.59	28.9	6.50	32.1	7.47
	27	16.3	3.51	19.4	4.25	22.6	5.06	24.2	5.51	25.7	5.95	28.9	6.92	32.1	7.97
	29	16.3	3.70	19.4	4.50	22.6	5.39	24.2	5.86	25.7	6.34	28.9	7.39	32.1	8.51
	31	16.3	3.94	19.4	4.79	22.6	5.72	24.2	6.23	25.7	6.75	28.9	7.85	32.1	9.06
	33	16.3	4.15	19.4	5.06	22.6	6.07	24.2	6.61	25.7	7.18	28.9	8.36	32.1	9.66
	35	16.3	4.40	19.4	5.37	22.6	6.44	24.2	7.02	25.7	7.62	28.9	8.90	32.1	10.28
	37	16.3	4.65	19.4	5.68	22.6	6.83	23.7	7.45	25.7	8.09	28.9	9.46	32.1	10.94
	39	16.3	4.91	19.4	6.01	22.6	7.23	23.4	7.89	25.7	8.59	28.9	10.05	32.1	11.64
41	15.4	5.55	18.4	6.77	21.5	8.11	23.0	8.14	24.5	8.84	27.5	10.33	30.6	11.92	
43	14.6	5.78	17.5	7.05	20.9	8.55	22.5	8.65	23.7	9.18	27.2	10.59	29.9	12.23	
44	14.4	6.03	17.5	7.36	20.5	9.01	22.0	9.20	23.5	9.53	26.5	10.86	29.5	12.54	
47	13.5	8.03	16.9	9.79	19.8	9.46	21.2	9.34	22.6	10.14	25.6	11.66	28.6	13.46	
50	12.4	7.88	15.1	9.62	17.7	9.98	18.9	10.11	20.2	10.82	22.8	12.46	25.7	14.08	
52	9.8	6.00	13.1	7.47	16.2	8.41	17.9	8.83	18.0	8.54	18.4	8.42	19.4	8.65	

GMV6 HR DC Inverter VRF Units Technical Sales Guide

TC—Total capacity of outdoor unit; PI—Power input of outdoor unit															
Combination	Outdoor air temp (°C DB)	Indoor air temp													
		14.0°C WB		16.0°C WB		18.0°C WB		19.0°C WB		20.0°C WB		22.0°C WB		24.0°C WB	
		20.0°C DB		23.0°C DB		26.0°C DB		27.0°C DB		28.0°C DB		30.0°C DB		32.0°C DB	
		TC	PI	TC	PI	TC	PI	TC	PI	TC	PI	TC	PI	TC	PI
		kW	kW	kW	kW	kW	kW	kW	kW	kW	kW	kW	kW	kW	
50%	-5	13.6	1.96	16.2	2.34	18.8	2.77	20.1	3.00	21.4	3.24	24.1	3.75	26.8	4.29
	0	13.6	1.96	16.2	2.35	18.8	2.78	20.1	3.00	21.4	3.24	24.1	3.76	26.8	4.30
	4	13.6	1.97	16.2	2.36	18.8	2.79	20.1	3.02	21.4	3.26	24.1	3.77	26.8	4.31
	7	13.6	2.01	16.2	2.40	18.8	2.84	20.1	3.07	21.4	3.32	24.1	3.84	26.8	4.39
	10	13.6	2.60	16.2	3.01	18.8	3.43	20.1	3.67	21.4	3.88	24.1	4.36	26.8	4.87
	12	13.6	2.62	16.2	3.04	18.8	3.49	20.1	3.70	21.4	3.96	24.1	4.44	26.8	4.95
	14	13.6	2.66	16.2	3.08	18.8	3.53	20.1	3.78	21.4	4.01	24.1	4.52	26.8	5.04
	16	13.6	2.70	16.2	3.12	18.8	3.59	20.1	3.84	21.4	4.07	24.1	4.60	26.8	5.12
	18	13.6	2.73	16.2	3.18	18.8	3.65	20.1	3.90	21.4	4.15	24.1	4.67	26.8	5.22
	20	13.6	2.77	16.2	3.22	18.8	3.70	20.1	3.98	21.4	4.23	24.1	4.77	26.8	5.31
	21	13.6	2.79	16.2	3.26	18.8	3.74	20.1	4.00	21.4	4.27	24.1	4.81	26.8	5.37
	23	13.6	2.83	16.2	3.30	18.8	3.80	20.1	4.07	21.4	4.34	24.1	4.89	26.8	5.49
	25	13.6	2.87	16.2	3.36	18.8	3.88	20.1	4.15	21.4	4.48	24.1	5.14	26.8	5.86
	27	13.6	2.93	16.2	3.49	18.8	4.09	20.1	4.42	21.4	4.75	24.1	5.47	26.8	6.24
	29	13.6	3.08	16.2	3.68	18.8	4.34	20.1	4.69	21.4	5.06	24.1	5.82	26.8	6.65
	31	13.6	3.26	16.2	3.90	18.8	4.64	20.1	4.98	21.4	5.37	24.1	6.19	26.8	7.08
	33	13.6	3.45	16.2	4.13	18.8	4.89	20.1	5.28	21.4	5.70	24.1	6.57	26.8	7.52
	35	13.6	3.65	16.2	4.36	18.8	5.16	20.1	5.59	21.4	6.03	24.1	6.98	26.8	7.99
	37	13.6	3.84	16.2	4.62	18.8	5.47	19.8	5.92	21.4	6.40	24.1	7.41	26.8	8.49
	39	13.6	4.05	16.2	4.87	18.8	5.78	19.5	6.26	21.4	6.79	24.1	7.85	26.8	9.02
41	12.8	4.59	15.4	5.50	17.9	6.50	19.1	6.48	20.3	7.00	22.9	8.10	25.5	9.27	
43	12.1	4.80	14.6	5.77	17.4	6.85	18.8	6.94	20.0	7.27	22.3	8.31	24.9	9.51	
44	12.0	4.99	14.6	5.98	17.1	7.22	18.3	7.32	19.5	7.54	22.1	8.52	24.6	9.75	
47	11.3	6.65	14.1	7.95	16.5	7.58	17.7	7.43	18.8	8.02	21.3	9.15	23.8	10.47	
50	10.3	6.53	12.6	7.81	14.7	8.00	15.8	8.04	16.8	8.56	19.0	9.77	21.4	10.95	
52	8.1	4.78	10.9	5.95	13.5	6.69	14.9	7.02	15.0	6.79	15.3	6.70	16.2	6.88	

GMV-VQ450WM/C-X

TC—Total capacity of outdoor unit; PI—Power input of outdoor unit															
Combination	Outdoor air temp (°C DB)	Indoor air temp													
		14.0°C WB		16.0°C WB		18.0°C WB		19.0°C WB		20.0°C WB		22.0°C WB		24.0°C WB	
		20.0°C DB		23.0°C DB		26.0°C DB		27.0°C DB		28.0°C DB		30.0°C DB		32.0°C DB	
		TC	PI	TC	PI	TC	PI	TC	PI	TC	PI	TC	PI	TC	PI
		kW	kW	kW	kW	kW	kW	kW	kW	kW	kW	kW	kW	kW	
135%	-5	39.8	8.65	47.4	10.54	55.0	10.66	57.1	10.72	58.2	10.78	59.7	10.91	61.1	11.02
	0	39.8	8.67	47.4	10.56	55.0	10.68	57.1	10.74	58.2	10.80	59.7	10.93	61.1	11.04
	4	39.8	8.70	47.4	10.60	55.0	10.72	57.1	10.78	58.2	10.84	59.7	10.97	61.1	11.08
	7	39.8	8.86	47.4	10.79	55.0	10.92	57.1	10.98	58.2	11.04	59.7	11.17	61.1	11.29
	10	39.8	9.02	47.4	11.02	55.0	13.11	57.1	13.40	57.8	13.13	59.2	12.58	60.7	12.00
	12	39.8	9.18	47.4	11.24	55.0	13.37	56.3	13.32	57.1	13.06	58.4	12.48	59.9	12.29
	14	39.8	9.36	47.4	11.45	54.9	13.53	55.7	13.27	56.3	12.98	57.8	12.87	59.2	13.00
	16	39.8	9.52	47.4	11.68	54.2	13.48	54.9	13.37	55.5	13.42	57.0	13.56	58.4	13.69
	18	39.8	9.71	47.4	11.92	53.4	13.98	54.1	14.06	54.9	14.14	56.3	14.27	57.8	14.40
	20	39.8	9.92	47.4	12.69	52.6	14.66	53.4	14.74	54.1	14.82	55.5	14.95	57.0	15.11
	21	39.8	10.18	47.4	13.13	52.3	15.01	53.1	15.09	53.7	15.17	55.2	15.32	56.6	15.46
	23	39.8	10.92	47.4	14.08	51.6	15.69	52.3	15.77	52.9	15.85	54.4	16.01	55.8	16.17
	25	39.8	11.66	47.4	15.09	50.8	16.38	51.6	16.46	52.3	16.56	53.7	16.72	55.2	16.88
	27	39.8	12.45	47.4	16.14	50.2	14.43	50.8	17.17	51.5	17.25	52.9	17.43	54.4	17.62
	29	39.8	13.29	47.4	17.25	49.4	17.75	50.0	17.86	50.8	17.96	52.3	18.15	53.7	18.33
	31	39.8	14.19	47.3	18.25	48.6	18.46	49.4	18.57	50.0	18.65	51.5	18.86	52.9	19.07
	33	39.8	15.11	46.4	18.94	47.9	19.12	48.6	19.25	49.4	19.36	50.8	19.57	52.1	19.81
	35	39.8	16.11	45.6	19.62	47.1	19.86	47.9	19.97	48.6	20.07	50.0	20.31	51.5	20.52
	37	39.8	17.14	45.0	20.33	46.4	20.57	47.1	20.68	47.9	20.81	49.2	21.05	50.7	21.28
	39	39.8	18.25	44.2	21.02	45.6	21.26	46.4	21.39	47.1	21.52	48.6	21.76	50.0	22.02
41	37.6	20.30	43.4	24.72	44.7	25.02	45.5	23.16	46.2	23.28	47.6	23.56	49.0	23.80	
43	35.6	21.17	42.5	25.77	43.9	26.38	44.6	24.61	45.3	24.17	46.7	24.15	48.1	24.40	
44	35.0	22.08	41.1	26.88	42.6	27.80	43.6	26.15	44.3	25.09	45.8	24.78	47.3	25.03	
47	33.0	29.38	39.7	35.77	41.2	29.19	42.1	26.55	42.7	26.69	44.3	26.60	45.8	26.88	
50	30.3	28.85	35.6	35.12	36.8	30.78	37.5	28.75	38.1	28.50	39.5	28.43	41.2	28.11	
52	19.3	17.07	26.0	21.25	32.2	23.92	35.4	25.11	35.6	24.28	36.4	23.96	38.5	24.60	

TC—Total capacity of outdoor unit; PI—Power input of outdoor unit															
Combination	Outdoor air temp (°C DB)	Indoor air temp													
		14.0°C WB		16.0°C WB		18.0°C WB		19.0°C WB		20.0°C WB		22.0°C WB		24.0°C WB	
		20.0°C DB		23.0°C DB		26.0°C DB		27.0°C DB		28.0°C DB		30.0°C DB		32.0°C DB	
		TC	PI	TC	PI	TC	PI	TC	PI	TC	PI	TC	PI	TC	PI
		kW	kW	kW	kW	kW	kW	kW	kW	kW	kW	kW	kW	kW	
120%	-5	36.7	7.70	43.7	9.97	50.8	10.59	54.4	10.65	57.2	10.71	58.5	10.82	59.8	10.93
	0	36.7	7.72	43.7	9.99	50.8	10.61	54.4	10.67	57.2	10.73	58.5	10.84	59.8	10.95
	4	36.7	7.75	43.7	10.03	50.8	10.65	54.4	10.71	57.2	10.77	58.5	10.88	59.8	11.00
	7	36.7	7.89	43.7	10.21	50.8	10.85	54.4	10.91	57.2	10.97	58.5	11.08	59.8	11.20
	10	36.7	8.23	43.7	10.05	50.8	11.95	54.4	12.92	57.0	13.48	58.3	12.95	59.6	12.45
	12	36.7	8.39	43.7	10.23	50.8	12.19	54.4	13.16	56.2	13.40	57.5	12.90	58.7	12.37
	14	36.7	8.55	43.7	10.44	50.8	12.42	54.4	13.42	55.3	13.32	56.8	12.82	58.1	12.90
	16	36.7	8.70	43.7	10.66	50.8	12.66	54.1	13.53	54.7	13.35	56.0	13.48	57.3	13.58
	18	36.7	8.86	43.7	10.87	50.8	13.11	53.2	13.98	53.9	14.03	55.2	14.16	56.6	14.30
	20	36.7	9.05	43.7	11.29	50.8	14.08	52.6	14.66	53.2	14.72	54.5	14.85	55.8	14.98
	21	36.7	9.13	43.7	11.68	50.8	14.59	52.1	15.01	52.8	15.06	54.2	15.19	55.5	15.35
	23	36.7	9.76	43.7	12.53	50.8	15.61	51.5	15.67	52.1	15.75	53.4	15.90	54.7	16.04
	25	36.7	10.42	43.7	13.40	50.0	16.30	50.7	16.35	51.3	16.43	52.8	16.59	54.1	16.75
	27	36.7	11.13	43.7	14.32	49.4	16.96	50.0	17.06	50.7	17.14	52.0	17.30	53.2	17.46
	29	36.7	11.87	43.7	15.30	48.6	17.64	49.2	17.75	49.8	17.83	51.1	18.01	52.6	18.17
	31	36.7	12.66	43.7	16.33	47.9	18.36	48.6	18.44	49.2	18.54	50.5	18.73	51.8	18.91
	33	36.7	13.48	43.7	17.43	47.1	19.04	47.7	19.15	48.4	19.23	49.7	19.44	51.0	19.62
	35	36.7	14.35	43.7	18.57	46.3	19.73	46.9	19.83	47.7	19.94	49.0	20.15	50.3	20.36
	37	36.7	15.27	43.7	19.78	45.6	20.44	46.3	20.55	46.9	20.65	48.2	20.86	49.5	21.10
	39	36.7	16.25	43.5	20.89	44.8	21.13	45.5	21.26	46.1	21.36	47.6	21.60	48.9	21.81
41	34.7	18.08	41.5	23.40	44.0	24.86	44.6	23.01	45.4	23.13	46.7	23.37	48.0	23.62	
43	32.8	18.84	39.6	24.39	43.1	26.19	43.8	24.44	44.7	24.01	45.8	23.97	47.1	24.23	
44	32.3	19.66	39.3	25.44	41.9	27.62	42.7	25.98	43.6	24.92	44.9	24.58	46.3	24.84	
47	30.5	26.16	38.0	33.85	40.5	29.00	41.2	26.38	42.0	26.52	43.4	26.40	44.8	26.67	
50	27.9	25.68	34.1	33.24	36.1	30.58	36.7	28.56	37.5	28.31	38.7	28.21	40.3	27.89	
52	18.9	16.96	25.5	21.11	31.5	23.76	34.7	24.95	34.9	24.12	35.7	23.80	37.7	24.43	
110%	-5	33.7	6.81	40.1	8.77	46.6	10.52	49.8	10.58	53.1	10.64	57.2	10.74	58.4	10.83
	0	33.7	6.83	40.1	8.78	46.6	10.54	49.8	10.60	53.1	10.66	57.2	10.76	58.4	10.86
	4	33.7	6.85	40.1	8.82	46.6	10.58	49.8	10.64	53.1	10.70	57.2	10.80	58.4	10.90
	7	33.7	6.98	40.1	8.98	46.6	10.78	49.8	10.84	53.1	10.89	57.2	11.00	58.4	11.10
	10	33.7	7.46	40.1	9.10	46.6	10.81	49.8	11.68	53.1	12.58	57.1	13.35	58.4	12.90
	12	33.7	7.62	40.1	9.28	46.6	11.02	49.8	11.92	53.1	12.82	56.5	13.29	57.6	12.82
	14	33.7	7.75	40.1	9.44	46.6	11.24	49.8	12.13	53.1	13.06	55.7	13.29	57.0	12.79
	16	33.7	7.89	40.1	9.63	46.6	11.45	49.8	12.37	53.1	13.32	55.0	13.37	56.2	13.50
	18	33.7	8.04	40.1	9.81	46.6	11.68	49.8	12.71	53.1	13.95	54.2	14.06	55.5	14.19
	20	33.7	8.20	40.1	10.02	46.6	12.37	49.8	13.66	52.3	14.64	53.6	14.74	54.7	14.88
	21	33.7	8.28	40.1	10.31	46.6	12.82	49.8	14.16	52.0	14.98	53.1	15.09	54.4	15.22
	23	33.7	8.68	40.1	11.05	46.6	13.74	49.8	15.19	51.1	15.64	52.4	15.80	53.6	15.93
	25	33.7	9.23	40.1	11.82	46.6	14.69	49.8	16.27	50.5	16.33	51.6	16.48	52.9	16.62
	27	33.7	9.86	40.1	12.63	46.6	15.72	49.0	16.96	49.7	17.01	51.0	17.17	52.1	17.33
	29	33.7	10.52	40.1	13.48	46.6	16.80	48.4	17.64	49.0	17.72	50.2	17.88	51.5	18.04
	31	33.7	11.21	40.1	14.37	46.6	17.93	47.6	18.33	48.2	18.41	49.5	18.57	50.7	18.75
	33	33.7	11.92	40.1	15.32	46.3	18.91	46.9	19.02	47.6	19.10	48.7	19.28	50.0	19.46
	35	33.7	12.69	40.1	16.33	45.6	19.60	46.1	19.70	46.8	19.81	47.9	19.99	49.2	20.18
	37	33.7	13.50	40.1	17.38	44.8	20.31	45.5	20.39	46.0	20.49	47.3	20.70	48.4	20.89
	39	33.7	14.35	40.1	18.52	44.0	20.99	44.7	21.10	45.3	21.21	46.4	21.42	47.7	21.63
41	31.8	15.98	38.1	20.57	43.4	24.69	43.8	22.85	44.5	22.98	45.6	23.19	46.9	23.40	
43	30.1	16.67	36.2	21.45	42.7	26.02	43.0	24.30	43.7	23.85	44.8	23.78	46.0	23.99	
44	29.6	17.38	36.1	22.37	41.3	27.43	42.0	25.81	42.7	24.76	43.9	24.39	45.3	24.62	
47	27.9	23.13	34.9	29.76	39.9	28.81	40.5	26.20	41.2	26.34	42.4	26.19	43.8	26.43	
50	25.6	22.71	31.3	29.22	35.6	30.37	36.1	28.37	36.7	28.13	37.8	27.99	39.4	27.64	
52	18.6	16.85	25.0	20.97	31.0	23.60	34.1	24.78	34.3	23.96	35.1	23.64	37.1	24.27	

GMV6 HR DC Inverter VRF Units Technical Sales Guide

TC—Total capacity of outdoor unit; PI—Power input of outdoor unit

Combination	Outdoor air temp (°C DB)	Indoor air temp													
		14.0°C WB		16.0°C WB		18.0°C WB		19.0°C WB		20.0°C WB		22.0°C WB		24.0°C WB	
		20.0°C DB		23.0°C DB		26.0°C DB		27.0°C DB		28.0°C DB		30.0°C DB		32.0°C DB	
		TC	PI	TC	PI	TC	PI	TC	PI	TC	PI	TC	PI	TC	PI
		kW	kW	kW	kW	kW	kW	kW	kW	kW	kW	kW	kW	kW	
100%	-5	30.6	5.96	36.4	7.63	42.4	9.51	45.0	10.51	48.2	10.56	54.2	10.66	57.3	10.75
	0	30.6	5.97	36.4	7.64	42.4	9.53	45.0	10.53	48.2	10.58	54.2	10.68	57.3	10.77
	4	30.6	5.99	36.4	7.67	42.4	9.56	45.0	10.57	48.2	10.62	54.2	10.72	57.3	10.81
	7	30.6	6.10	36.4	7.81	42.4	9.74	45.0	10.76	48.2	10.82	54.2	10.91	57.3	11.01
	10	30.6	6.75	36.4	8.20	42.4	9.70	45.0	10.48	48.2	11.31	54.2	12.80	57.3	13.31
	12	30.6	6.84	36.4	8.31	42.4	9.83	45.0	10.61	48.2	11.53	54.2	13.02	56.5	13.20
	14	30.6	6.96	36.4	8.46	42.4	10.00	45.0	10.81	48.2	11.74	54.2	13.25	55.8	13.10
	16	30.6	7.12	36.4	8.65	42.4	10.22	45.0	11.05	48.2	12.01	54.0	13.55	55.0	13.39
	18	30.6	7.28	36.4	8.84	42.4	10.42	45.0	11.27	48.2	12.24	53.2	13.81	54.4	14.02
	20	30.6	7.39	36.4	8.97	42.4	10.77	45.0	11.86	48.2	13.02	52.4	14.54	53.6	14.76
	21	30.6	7.46	36.4	9.06	42.4	11.13	45.0	12.26	48.2	13.47	52.1	15.03	53.2	15.17
	23	30.6	7.65	36.4	9.68	42.4	11.97	45.0	13.19	48.2	14.48	51.5	15.91	52.4	16.05
	25	30.6	8.14	36.4	10.30	42.4	12.74	45.0	14.03	48.2	15.49	50.7	16.49	51.8	16.63
	27	30.6	8.70	36.4	11.01	42.4	13.67	45.0	15.05	48.2	16.62	49.8	17.07	51.0	17.22
	29	30.6	9.21	36.4	11.76	42.4	14.62	45.0	16.10	48.1	17.60	49.2	17.89	50.3	18.05
	31	30.6	9.80	36.4	12.52	42.4	15.58	45.0	17.35	47.5	18.32	48.0	18.61	49.5	18.78
	33	30.6	10.43	36.4	13.34	42.4	16.61	45.0	18.36	46.6	18.98	47.8	19.15	48.8	19.32
	35	30.6	11.09	36.4	14.20	42.4	17.71	45.0	19.57	45.8	19.67	46.9	19.84	48.0	20.02
	37	30.6	11.81	36.4	15.13	42.4	18.86	44.5	20.27	45.2	20.38	46.2	20.52	47.4	20.70
	39	30.6	12.58	36.4	16.11	42.4	20.09	43.9	20.94	44.1	21.05	45.6	21.20	46.2	21.39
41	28.9	13.98	34.6	17.90	40.3	22.32	43.1	22.70	43.6	22.81	44.6	23.02	45.8	23.23	
43	27.3	14.57	32.9	18.67	39.3	23.52	42.3	24.13	43.0	23.68	43.7	23.61	45.3	23.82	
44	26.9	15.20	32.8	19.46	38.4	24.80	41.2	25.64	41.8	24.58	43.0	24.21	44.2	24.43	
47	25.4	20.22	31.7	25.89	37.1	26.03	39.8	26.03	40.3	26.16	41.5	26.00	42.8	26.23	
50	23.2	19.86	28.4	25.43	33.1	27.45	35.5	28.18	36.0	27.93	37.1	27.78	38.4	27.43	
52	18.3	15.34	24.6	19.09	30.4	21.48	33.5	22.56	33.7	21.81	34.5	21.52	36.4	22.10	
90%	-5	27.5	5.20	32.8	6.58	38.2	8.12	40.8	8.97	43.4	9.87	48.7	10.56	54.1	10.66
	0	27.5	5.21	32.8	6.59	38.2	8.14	40.8	8.99	43.4	9.89	48.7	10.58	54.1	10.68
	4	27.5	5.23	32.8	6.62	38.2	8.17	40.8	9.02	43.4	9.93	48.7	10.62	54.1	10.72
	7	27.5	5.32	32.8	6.74	38.2	8.32	40.8	9.19	43.4	10.11	48.7	10.82	54.1	10.92
	10	27.5	5.89	32.8	7.08	38.2	8.29	40.8	9.33	43.4	9.94	48.8	11.39	54.0	12.90
	12	27.5	5.97	32.8	7.17	38.2	8.39	40.8	9.46	43.4	10.13	48.8	11.58	54.0	13.07
	14	27.5	6.07	32.8	7.29	38.2	8.54	40.8	9.60	43.4	10.31	48.8	11.78	54.0	13.28
	16	27.5	6.21	32.8	7.46	38.2	8.73	40.8	9.82	43.4	10.54	48.8	12.05	53.9	13.54
	18	27.5	6.35	32.8	7.62	38.2	8.90	40.8	10.01	43.4	10.74	48.8	12.33	53.4	14.03
	20	27.5	6.44	32.8	7.74	38.2	9.20	40.8	10.21	43.4	11.19	48.8	13.25	52.4	14.62
	21	27.5	6.51	32.8	7.82	38.2	9.51	40.8	10.55	43.4	11.57	48.8	13.70	52.1	14.94
	23	27.5	6.68	32.8	8.35	38.2	10.22	40.8	11.35	43.4	12.39	48.8	14.71	51.3	15.71
	25	27.5	7.10	32.8	8.89	38.2	10.88	40.8	12.11	43.4	13.25	48.8	15.74	50.7	16.35
	27	27.5	7.59	32.8	9.49	38.2	11.67	40.8	12.92	43.4	14.19	48.8	16.79	49.8	17.07
	29	27.5	8.04	32.8	10.14	38.2	12.48	40.8	13.81	43.4	15.14	48.2	17.60	49.2	17.76
	31	27.5	8.55	32.8	10.80	38.2	13.31	40.8	14.74	43.4	16.16	47.4	18.24	48.4	18.48
	33	27.5	9.10	32.8	11.50	38.2	14.19	40.8	15.68	43.4	17.19	46.8	18.98	47.7	19.15
	35	27.5	9.68	32.8	12.25	38.2	15.13	40.8	16.71	43.4	18.38	46.0	19.67	46.9	19.85
	37	27.5	10.31	32.8	13.05	38.2	16.11	40.1	17.31	43.4	19.67	45.2	20.38	46.3	20.32
	39	27.5	10.98	32.8	13.90	38.2	17.16	39.5	17.89	43.4	20.85	44.5	21.13	45.5	21.08
41	26.0	12.19	31.1	15.44	36.3	19.06	38.8	19.39	41.3	21.33	43.8	22.82	44.7	23.02	
43	24.6	12.71	29.6	16.09	35.3	20.10	38.0	20.60	40.5	22.14	43.0	23.40	44.0	23.65	
44	24.2	13.26	29.5	16.78	34.5	21.18	37.1	21.89	39.6	22.98	42.1	24.00	43.2	24.21	
47	22.8	17.64	28.5	22.33	33.4	22.23	35.8	22.23	38.2	24.45	40.7	25.77	41.8	26.00	
50	20.9	17.32	25.6	21.93	29.8	23.44	31.9	24.07	34.1	26.11	36.3	27.54	37.5	27.19	
52	16.5	14.30	22.1	17.80	27.4	20.03	30.2	21.03	30.3	20.34	31.4	20.06	32.8	20.60	

TC—Total capacity of outdoor unit; PI—Power input of outdoor unit															
Combination	Outdoor air temp (°C DB)	Indoor air temp													
		14.0°C WB		16.0°C WB		18.0°C WB		19.0°C WB		20.0°C WB		22.0°C WB		24.0°C WB	
		20.0°C DB		23.0°C DB		26.0°C DB		27.0°C DB		28.0°C DB		30.0°C DB		32.0°C DB	
		TC	PI	TC	PI	TC	PI	TC	PI	TC	PI	TC	PI	TC	PI
		kW	kW	kW	kW	kW	kW	kW	kW	kW	kW	kW	kW	kW	
80%	-5	24.5	4.49	29.1	5.54	33.9	6.88	36.3	7.58	38.5	8.28	43.4	9.83	48.1	10.53
	0	24.5	4.50	29.1	5.55	33.9	6.90	36.3	7.59	38.5	8.30	43.4	9.85	48.1	10.55
	4	24.5	4.51	29.1	5.57	33.9	6.92	36.3	7.62	38.5	8.33	43.4	9.89	48.1	10.59
	7	24.5	4.60	29.1	5.67	33.9	7.05	36.3	7.76	38.5	8.48	43.4	10.07	48.1	10.79
	10	24.5	5.35	29.1	6.41	33.9	7.54	36.3	8.12	38.6	8.70	43.4	9.94	48.1	11.54
	12	24.5	5.43	29.1	6.51	33.9	7.68	36.3	8.28	38.6	8.87	43.4	10.11	48.1	11.45
	14	24.5	5.54	29.1	6.65	33.9	7.81	36.3	8.41	38.6	9.03	43.4	10.28	48.1	11.71
	16	24.5	5.62	29.1	6.75	33.9	7.97	36.3	8.57	38.6	9.17	43.4	10.52	48.1	12.13
	18	24.5	5.72	29.1	6.88	33.9	8.14	36.3	8.76	38.6	9.34	43.4	10.75	48.1	12.97
	20	24.5	5.83	29.1	7.02	33.9	8.28	36.3	8.91	38.6	9.55	43.4	11.14	48.1	13.44
	21	24.5	5.88	29.1	7.07	33.9	8.36	36.3	9.02	38.6	9.77	43.4	11.55	48.1	14.39
	23	24.5	5.99	29.1	7.23	33.9	8.76	36.3	9.60	38.6	10.45	43.4	12.35	48.1	15.39
	25	24.5	6.17	29.1	7.68	33.9	9.36	36.3	10.26	38.6	11.15	43.4	13.22	48.1	16.43
	27	24.5	6.57	29.1	8.18	33.9	9.97	36.3	10.95	38.6	11.96	43.4	14.11	48.1	17.01
	29	24.5	6.99	29.1	8.70	33.9	10.63	36.3	11.66	38.5	12.75	43.4	15.06	48.1	17.62
	31	24.5	7.41	29.1	9.26	33.9	11.31	36.3	12.42	38.5	13.60	43.4	16.07	47.3	18.26
	33	24.5	7.89	29.1	10.31	33.9	12.05	36.3	13.24	38.5	14.48	43.4	17.15	46.6	18.93
	35	24.5	8.36	29.1	10.31	33.9	12.82	36.3	14.11	38.5	15.42	43.4	18.31	45.8	19.61
	37	24.5	8.86	29.1	11.10	33.9	13.64	35.6	15.03	38.5	16.42	43.4	19.50	45.2	20.34
	39	24.5	9.39	29.1	11.79	33.9	14.51	35.1	16.00	38.5	17.49	43.4	20.76	44.3	21.09
41	23.1	10.53	27.7	12.99	32.2	16.15	34.5	16.37	36.6	17.89	41.3	21.24	43.6	22.75	
43	21.9	10.98	26.9	13.56	31.4	17.01	33.8	17.40	35.8	18.57	40.5	21.78	43.0	23.33	
44	21.5	11.45	26.2	14.13	30.7	17.95	33.0	18.48	35.1	19.28	39.7	22.33	42.1	23.93	
47	20.3	15.24	25.3	18.80	29.7	18.84	31.8	18.77	33.8	20.51	38.4	23.98	40.8	25.69	
50	18.6	14.97	22.7	18.46	26.5	19.87	28.4	20.32	30.2	21.90	34.3	25.63	36.6	26.87	
52	14.6	12.07	19.7	15.02	24.3	16.90	26.8	17.75	26.9	17.16	27.6	16.93	29.1	17.38	
70%	-5	21.4	3.82	25.5	4.73	29.7	5.74	31.7	6.29	33.8	6.85	37.9	8.07	42.1	9.39
	0	21.4	3.83	25.5	4.74	29.7	5.75	31.7	6.30	33.8	6.87	37.9	8.09	42.1	9.41
	4	21.4	3.85	25.5	4.76	29.7	5.77	31.7	6.32	33.8	6.89	37.9	8.12	42.1	9.44
	7	21.4	3.92	25.5	4.85	29.7	5.87	31.7	6.44	33.8	7.02	37.9	8.27	42.1	9.62
	10	21.4	4.72	25.5	5.59	29.7	6.51	31.7	7.02	33.8	7.52	37.9	8.55	42.1	9.60
	12	21.4	4.77	25.5	5.67	29.7	6.65	31.7	7.15	33.8	7.65	37.9	8.70	42.1	9.79
	14	21.4	4.85	25.5	5.78	29.7	6.75	31.7	7.25	33.8	7.78	37.9	8.86	42.1	9.97
	16	21.4	4.93	25.5	5.88	29.7	6.88	31.7	7.41	33.8	7.94	37.9	9.02	42.1	10.15
	18	21.4	5.01	25.5	5.99	29.7	7.02	31.7	7.54	33.8	8.07	37.9	9.20	42.1	10.37
	20	21.4	5.09	25.5	6.09	29.7	7.15	31.7	7.68	33.8	8.23	37.9	9.39	42.1	10.66
	21	21.4	5.14	25.5	6.15	29.7	7.20	31.7	7.75	33.8	8.31	37.9	9.49	42.1	11.02
	23	21.4	5.22	25.5	6.25	29.7	7.36	31.7	8.02	33.8	8.73	37.9	10.21	42.1	11.82
	25	21.4	5.33	25.5	6.51	29.7	7.83	31.7	8.57	33.8	9.31	37.9	10.92	42.1	12.63
	27	21.4	5.64	25.5	6.94	29.7	8.36	31.7	9.13	33.8	9.94	37.9	11.66	42.1	13.50
	29	21.4	5.99	25.5	7.36	29.7	8.89	31.7	9.73	33.8	10.58	37.9	12.42	42.1	14.43
	31	21.4	6.33	25.5	7.81	29.7	9.47	31.7	10.34	33.8	11.26	37.9	13.24	42.1	15.38
	33	21.4	6.73	25.5	8.31	29.7	10.08	31.7	11.00	33.8	12.00	37.9	14.11	42.1	16.41
	35	21.4	7.12	25.5	8.81	29.7	10.68	31.7	11.71	33.8	12.77	37.9	15.03	42.1	17.49
	37	21.4	7.52	25.5	9.34	29.7	11.37	31.2	12.45	33.8	13.58	37.9	16.01	42.1	18.62
	39	21.4	7.97	25.5	9.89	29.7	12.05	30.7	13.21	33.8	14.43	37.9	17.01	42.1	19.83
41	20.2	8.97	24.2	11.10	28.2	13.46	30.2	13.58	32.1	14.81	36.1	17.44	40.1	20.28	
43	19.1	9.35	23.5	11.58	27.2	14.18	29.6	14.44	30.5	15.36	35.4	17.88	39.0	20.80	
44	18.8	9.76	22.9	12.07	26.9	14.95	28.9	15.34	30.8	15.96	34.8	18.34	38.7	21.33	
47	17.8	12.98	22.2	16.06	26.0	15.70	27.9	15.57	29.7	16.98	33.6	19.69	37.4	22.91	
50	16.3	12.75	19.9	15.77	23.2	16.56	24.8	16.86	26.5	18.13	30.0	21.05	33.7	23.96	
52	12.8	10.01	17.2	12.47	21.3	13.90	23.5	14.73	23.6	14.24	24.1	14.05	25.5	14.43	

GMV6 HR DC Inverter VRF Units Technical Sales Guide

TC—Total capacity of outdoor unit; PI—Power input of outdoor unit															
Combination	Outdoor air temp (°C DB)	Indoor air temp													
		14.0°C WB		16.0°C WB		18.0°C WB		19.0°C WB		20.0°C WB		22.0°C WB		24.0°C WB	
		20.0°C DB		23.0°C DB		26.0°C DB		27.0°C DB		28.0°C DB		30.0°C DB		32.0°C DB	
		TC	PI	TC	PI	TC	PI	TC	PI	TC	PI	TC	PI	TC	PI
		kW	kW	kW	kW	kW	kW	kW	kW	kW	kW	kW	kW	kW	
60%	-5	18.4	3.22	21.8	3.92	25.4	4.70	27.2	5.13	29.0	5.57	32.5	6.50	36.1	7.51
	0	18.4	3.22	21.8	3.93	25.4	4.71	27.2	5.14	29.0	5.58	32.5	6.51	36.1	7.52
	4	18.4	3.23	21.8	3.95	25.4	4.73	27.2	5.16	29.0	5.60	32.5	6.54	36.1	7.55
	7	18.4	3.29	21.8	4.02	25.4	4.82	27.2	5.25	29.0	5.70	32.5	6.66	36.1	7.69
	10	18.4	4.09	21.8	4.80	25.4	5.57	27.2	5.96	28.9	6.36	32.5	7.20	36.1	8.07
	12	18.4	4.17	21.8	4.88	25.4	5.67	27.2	6.07	28.9	6.46	32.5	7.33	36.1	8.20
	14	18.4	4.22	21.8	4.96	25.4	5.75	27.2	6.17	28.9	6.59	32.5	7.46	36.1	8.36
	16	18.4	4.27	21.8	5.04	25.4	5.86	27.2	6.28	28.9	6.70	32.5	7.60	36.1	8.52
	18	18.4	4.35	21.8	5.12	25.4	5.96	27.2	6.38	28.9	6.83	32.5	7.73	36.1	8.68
	20	18.4	4.40	21.8	5.22	25.4	6.07	27.2	6.51	28.9	6.96	32.5	7.89	36.1	8.86
	21	18.4	4.46	21.8	5.25	25.4	6.12	27.2	6.57	28.9	7.02	32.5	7.97	36.1	8.94
	23	18.4	4.51	21.8	5.35	25.4	6.22	27.2	6.70	28.9	7.15	32.5	8.28	36.1	9.52
	25	18.4	4.59	21.8	5.46	25.4	6.46	27.2	7.02	28.9	7.60	32.5	8.84	36.1	10.15
	27	18.4	4.77	21.8	5.78	25.4	6.88	27.2	7.49	28.9	8.10	32.5	9.42	36.1	10.84
	29	18.4	5.04	21.8	6.12	25.4	7.33	27.2	7.97	28.9	8.62	32.5	10.05	36.1	11.58
	31	18.4	5.35	21.8	6.51	25.4	7.78	27.2	8.47	28.9	9.18	32.5	10.68	36.1	12.32
	33	18.4	5.64	21.8	6.88	25.4	8.26	27.2	8.99	28.9	9.76	32.5	11.37	36.1	13.13
	35	18.4	5.99	21.8	7.31	25.4	8.76	27.2	9.55	28.9	10.37	32.5	12.11	36.1	13.98
	37	18.4	6.33	21.8	7.73	25.4	9.28	26.7	10.13	28.9	11.00	32.5	12.87	36.1	14.88
	39	18.4	6.67	21.8	8.18	25.4	9.84	26.3	10.73	28.9	11.68	32.5	13.66	36.1	15.82
41	17.3	7.54	20.8	9.21	24.2	11.03	25.8	11.08	27.5	12.02	31.0	14.04	34.4	16.22	
43	16.4	7.87	19.7	9.59	23.5	11.63	25.4	11.77	26.7	12.48	30.6	14.40	33.7	16.64	
44	16.2	8.20	19.7	10.01	23.0	12.26	24.7	12.51	26.4	12.96	29.8	14.77	33.2	17.05	
47	15.2	10.91	19.0	13.32	22.3	12.87	23.9	12.70	25.5	13.79	28.8	15.86	32.1	18.31	
50	13.9	10.72	17.0	13.08	19.9	13.57	21.3	13.75	22.7	14.72	25.7	16.95	28.9	19.15	
52	11.0	8.16	14.8	10.16	18.3	11.44	20.1	12.01	20.2	11.61	20.7	11.46	21.8	11.76	
50%	-5	15.3	2.66	18.2	3.19	21.2	3.77	22.7	4.08	24.1	4.40	27.1	5.10	30.1	5.84
	0	15.3	2.67	18.2	3.19	21.2	3.77	22.7	4.09	24.1	4.41	27.1	5.11	30.1	5.85
	4	15.3	2.68	18.2	3.20	21.2	3.79	22.7	4.10	24.1	4.43	27.1	5.13	30.1	5.87
	7	15.3	2.73	18.2	3.26	21.2	3.86	22.7	4.18	24.1	4.51	27.1	5.22	30.1	5.98
	10	15.3	3.53	18.2	4.09	21.2	4.67	22.7	4.98	24.1	5.27	27.1	5.93	30.1	6.62
	12	15.3	3.56	18.2	4.14	21.2	4.75	22.7	5.04	24.1	5.38	27.1	6.04	30.1	6.73
	14	15.3	3.61	18.2	4.19	21.2	4.80	22.7	5.14	24.1	5.46	27.1	6.15	30.1	6.86
	16	15.3	3.67	18.2	4.25	21.2	4.88	22.7	5.22	24.1	5.54	27.1	6.25	30.1	6.96
	18	15.3	3.72	18.2	4.33	21.2	4.96	22.7	5.30	24.1	5.64	27.1	6.36	30.1	7.09
	20	15.3	3.77	18.2	4.38	21.2	5.04	22.7	5.41	24.1	5.75	27.1	6.49	30.1	7.23
	21	15.3	3.80	18.2	4.43	21.2	5.09	22.7	5.43	24.1	5.80	27.1	6.54	30.1	7.31
	23	15.3	3.85	18.2	4.48	21.2	5.17	22.7	5.54	24.1	5.91	27.1	6.65	30.1	7.46
	25	15.3	3.90	18.2	4.56	21.2	5.27	22.7	5.64	24.1	6.09	27.1	6.99	30.1	7.97
	27	15.3	3.98	18.2	4.75	21.2	5.57	22.7	6.01	24.1	6.46	27.1	7.44	30.1	8.49
	29	15.3	4.19	18.2	5.01	21.2	5.91	22.7	6.38	24.0	6.88	27.1	7.91	30.1	9.05
	31	15.3	4.43	18.2	5.30	21.2	6.30	22.7	6.78	24.0	7.31	27.1	8.41	30.1	9.63
	33	15.3	4.69	18.2	5.62	21.2	6.65	22.7	7.17	24.0	7.75	27.1	8.94	30.1	10.23
	35	15.3	4.96	18.2	5.93	21.2	7.02	22.7	7.60	24.0	8.20	27.1	9.49	30.1	10.87
	37	15.3	5.22	18.2	6.28	21.2	7.44	22.3	8.04	24.0	8.70	27.1	10.08	30.1	11.55
	39	15.3	5.51	18.2	6.62	21.2	7.86	21.9	8.52	24.0	9.23	27.1	10.68	30.1	12.26
41	14.5	6.25	17.3	7.48	20.1	8.84	21.5	8.81	22.9	9.51	25.8	11.01	28.7	12.60	
43	13.7	6.52	16.4	7.85	19.6	9.31	21.1	9.44	22.5	9.88	25.1	11.30	28.0	12.93	
44	13.5	6.79	16.4	8.13	19.2	9.82	20.6	9.95	21.9	10.25	24.8	11.58	27.7	13.26	
47	12.7	9.04	15.8	10.82	18.6	10.31	19.9	10.10	21.1	10.91	24.0	12.44	26.8	14.23	
50	11.6	8.88	14.2	10.62	16.6	10.87	17.7	10.94	18.9	11.65	21.4	13.29	24.1	14.89	
52	9.1	6.50	12.3	8.09	15.2	9.10	16.8	9.55	16.8	9.24	17.2	9.11	18.2	9.36	

GMV-VQ504WM/C-X

TC—Total capacity of outdoor unit; PI—Power input of outdoor unit

Combination	Outdoor air temp (°C DB)	Indoor air temp													
		14.0°C WB		16.0°C WB		18.0°C WB		19.0°C WB		20.0°C WB		22.0°C WB		24.0°C WB	
		20.0°C DB		23.0°C DB		26.0°C DB		27.0°C DB		28.0°C DB		30.0°C DB		32.0°C DB	
		TC	PI	TC	PI	TC	PI	TC	PI	TC	PI	TC	PI	TC	PI
		kW	kW	kW	kW	kW	kW	kW	kW	kW	kW	kW	kW	kW	
135%	-5	44.6	6.86	53.1	8.35	61.6	8.45	64.0	8.50	65.1	8.54	66.8	8.64	68.5	8.73
	0	44.6	6.87	53.1	8.37	61.6	8.47	64.0	8.51	65.1	8.56	66.8	8.66	68.5	8.75
	4	44.6	6.90	53.1	8.40	61.6	8.50	64.0	8.54	65.1	8.59	66.8	8.69	68.5	8.78
	7	44.6	7.02	53.1	8.55	61.6	8.66	64.0	8.70	65.1	8.75	66.8	8.85	68.5	8.94
	10	44.6	7.15	53.1	8.74	61.6	10.39	64.0	10.62	64.7	10.41	66.3	9.97	68.0	9.51
	12	44.6	7.27	53.1	8.90	61.6	10.60	63.1	10.56	64.0	10.35	65.4	9.89	67.1	9.74
	14	44.6	7.42	53.1	9.07	61.4	10.72	62.4	10.51	63.1	10.28	64.7	10.20	66.3	10.31
	16	44.6	7.55	53.1	9.26	60.7	10.68	61.4	10.60	62.2	10.64	63.8	10.74	65.4	10.85
	18	44.6	7.69	53.1	9.45	59.8	11.08	60.5	11.14	61.4	11.20	63.1	11.31	64.7	11.41
	20	44.6	7.86	53.1	10.05	58.9	11.62	59.8	11.68	60.5	11.75	62.2	11.85	63.8	11.98
	21	44.6	8.07	53.1	10.41	58.5	11.89	59.5	11.96	60.2	12.02	61.8	12.14	63.4	12.25
	23	44.6	8.65	53.1	11.16	57.8	12.44	58.5	12.50	59.3	12.56	60.9	12.69	62.5	12.81
	25	44.6	9.24	53.1	11.96	56.9	12.98	57.8	13.04	58.5	13.13	60.2	13.25	61.8	13.38
	27	44.6	9.87	53.1	12.79	56.2	11.43	56.9	13.61	57.6	13.67	59.3	13.82	60.9	13.96
	29	44.6	10.54	53.1	13.67	55.3	14.07	56.0	14.15	56.9	14.23	58.5	14.38	60.2	14.53
	31	44.6	11.25	52.9	14.46	54.4	14.63	55.3	14.72	56.0	14.78	57.6	14.95	59.3	15.11
	33	44.6	11.98	52.0	15.01	53.7	15.15	54.4	15.26	55.3	15.34	56.9	15.51	58.4	15.70
	35	44.6	12.77	51.1	15.55	52.7	15.74	53.7	15.82	54.4	15.91	56.0	16.10	57.6	16.26
	37	44.6	13.59	50.4	16.12	52.0	16.30	52.7	16.39	53.7	16.49	55.1	16.68	56.7	16.87
	39	44.6	14.46	49.5	16.66	51.1	16.85	52.0	16.95	52.7	17.06	54.4	17.24	56.0	17.45
41	42.1	16.09	48.6	19.60	50.1	19.83	51.0	18.36	51.7	18.45	53.3	18.67	54.9	18.86	
43	39.8	16.78	47.7	20.43	49.1	20.91	50.0	19.51	50.7	19.15	52.3	19.14	53.9	19.34	
44	39.2	17.50	46.0	21.31	47.7	22.04	48.8	20.73	49.6	19.88	51.3	19.64	53.0	19.84	
47	37.0	23.28	44.5	28.35	46.2	23.14	47.1	21.05	47.9	21.16	49.6	21.08	51.3	21.30	
50	33.9	22.86	39.9	27.84	41.2	24.40	42.0	22.79	42.7	22.59	44.2	22.53	46.1	22.28	
52	21.7	13.53	29.1	16.84	36.0	18.96	39.7	19.90	39.9	19.25	40.8	18.99	43.1	19.49	
120%	-5	41.1	6.11	48.9	7.90	56.9	8.40	60.9	8.44	64.1	8.49	65.5	8.58	67.0	8.67
	0	41.1	6.12	48.9	7.92	56.9	8.41	60.9	8.46	64.1	8.50	65.5	8.59	67.0	8.68
	4	41.1	6.14	48.9	7.95	56.9	8.44	60.9	8.49	64.1	8.53	65.5	8.62	67.0	8.71
	7	41.1	6.25	48.9	8.09	56.9	8.60	60.9	8.65	64.1	8.69	65.5	8.78	67.0	8.88
	10	41.1	6.52	48.9	7.96	56.9	9.47	60.9	10.24	63.8	10.68	65.3	10.26	66.7	9.87
	12	41.1	6.65	48.9	8.11	56.9	9.66	60.9	10.43	62.9	10.62	64.3	10.22	65.8	9.80
	14	41.1	6.77	48.9	8.28	56.9	9.85	60.9	10.64	62.0	10.56	63.6	10.16	65.1	10.22
	16	41.1	6.90	48.9	8.44	56.9	10.03	60.5	10.72	61.3	10.58	62.7	10.68	64.2	10.77
	18	41.1	7.02	48.9	8.61	56.9	10.39	59.6	11.08	60.4	11.12	61.8	11.22	63.4	11.33
	20	41.1	7.17	48.9	8.95	56.9	11.16	58.9	11.62	59.6	11.66	61.1	11.77	62.5	11.87
	21	41.1	7.23	48.9	9.26	56.9	11.56	58.4	11.89	59.1	11.94	60.7	12.04	62.2	12.17
	23	41.1	7.73	48.9	9.93	56.9	12.37	57.6	12.42	58.4	12.48	59.8	12.60	61.3	12.71
	25	41.1	8.26	48.9	10.62	56.0	12.92	56.7	12.96	57.5	13.02	59.1	13.15	60.5	13.27
	27	41.1	8.82	48.9	11.35	55.3	13.44	56.0	13.52	56.7	13.59	58.2	13.71	59.6	13.84
	29	41.1	9.41	48.9	12.12	54.4	13.98	55.1	14.07	55.8	14.13	57.3	14.28	58.9	14.40
	31	41.1	10.03	48.9	12.94	53.7	14.55	54.4	14.61	55.1	14.69	56.6	14.84	58.0	14.99
	33	41.1	10.68	48.9	13.82	52.7	15.09	53.5	15.18	54.2	15.24	55.6	15.41	57.1	15.55
	35	41.1	11.37	48.9	14.72	51.8	15.64	52.6	15.72	53.5	15.80	54.9	15.97	56.4	16.14
	37	41.1	12.10	48.9	15.68	51.1	16.20	51.8	16.28	52.6	16.37	54.0	16.53	55.5	16.72
	39	41.1	12.88	48.8	16.56	50.2	16.74	50.9	16.85	51.7	16.93	53.3	17.12	54.7	17.29
41	38.9	14.33	46.5	18.54	49.3	19.70	50.0	18.23	50.9	18.33	52.3	18.53	53.7	18.72	
43	36.7	14.93	44.3	19.33	48.3	20.76	49.0	19.37	50.1	19.03	51.3	18.99	52.7	19.20	
44	36.2	15.58	44.0	20.16	46.9	21.89	47.8	20.59	48.8	19.75	50.3	19.48	51.9	19.69	
47	34.2	20.73	42.6	26.83	45.4	22.98	46.2	20.91	47.1	21.02	48.6	20.92	50.2	21.14	
50	31.3	20.35	38.2	26.34	40.5	24.23	41.2	22.64	42.0	22.44	43.4	22.36	45.1	22.11	
52	21.2	13.44	28.5	16.73	35.3	18.83	38.9	19.77	39.0	19.12	40.0	18.86	42.2	19.37	

GMV6 HR DC Inverter VRF Units Technical Sales Guide

TC—Total capacity of outdoor unit; PI—Power input of outdoor unit															
Combination	Outdoor air temp (°C DB)	Indoor air temp													
		14.0°C WB		16.0°C WB		18.0°C WB		19.0°C WB		20.0°C WB		22.0°C WB		24.0°C WB	
		20.0°C DB		23.0°C DB		26.0°C DB		27.0°C DB		28.0°C DB		30.0°C DB		32.0°C DB	
		TC	PI	TC	PI	TC	PI	TC	PI	TC	PI	TC	PI	TC	PI
		kW	kW	kW	kW	kW	kW	kW	kW	kW	kW	kW	kW	kW	
110%	-5	37.7	5.40	45.0	6.95	52.2	8.34	55.8	8.38	59.5	8.43	64.1	8.51	65.4	8.59
	0	37.7	5.41	45.0	6.96	52.2	8.36	55.8	8.40	59.5	8.45	64.1	8.52	65.4	8.60
	4	37.7	5.43	45.0	6.99	52.2	8.39	55.8	8.43	59.5	8.48	64.1	8.56	65.4	8.64
	7	37.7	5.53	45.0	7.12	52.2	8.54	55.8	8.59	59.5	8.63	64.1	8.71	65.4	8.79
	10	37.7	5.92	45.0	7.21	52.2	8.57	55.8	9.26	59.5	9.97	64.0	10.58	65.4	10.22
	12	37.7	6.04	45.0	7.36	52.2	8.74	55.8	9.45	59.5	10.16	63.3	10.54	64.5	10.16
	14	37.7	6.15	45.0	7.48	52.2	8.90	55.8	9.62	59.5	10.35	62.4	10.54	63.8	10.14
	16	37.7	6.25	45.0	7.63	52.2	9.07	55.8	9.80	59.5	10.56	61.6	10.60	62.9	10.70
	18	37.7	6.38	45.0	7.78	52.2	9.26	55.8	10.08	59.5	11.06	60.7	11.14	62.2	11.25
	20	37.7	6.50	45.0	7.94	52.2	9.80	55.8	10.83	58.5	11.60	60.0	11.68	61.3	11.79
	21	37.7	6.56	45.0	8.17	52.2	10.16	55.8	11.22	58.2	11.87	59.5	11.96	60.9	12.06
	23	37.7	6.88	45.0	8.76	52.2	10.89	55.8	12.04	57.3	12.40	58.7	12.52	60.0	12.63
	25	37.7	7.32	45.0	9.36	52.2	11.64	55.8	12.90	56.6	12.94	57.8	13.06	59.3	13.17
	27	37.7	7.82	45.0	10.01	52.2	12.46	54.9	13.44	55.6	13.48	57.1	13.61	58.4	13.73
	29	37.7	8.34	45.0	10.68	52.2	13.32	54.2	13.98	54.9	14.05	56.2	14.17	57.6	14.30
	31	37.7	8.88	45.0	11.39	52.2	14.21	53.3	14.53	54.0	14.59	55.5	14.72	56.7	14.86
	33	37.7	9.45	45.0	12.14	51.8	14.99	52.6	15.07	53.3	15.13	54.6	15.28	56.0	15.43
	35	37.7	10.05	45.0	12.94	51.1	15.53	51.7	15.61	52.4	15.70	53.7	15.84	55.1	15.99
	37	37.7	10.70	45.0	13.78	50.2	16.10	50.9	16.16	51.5	16.24	52.9	16.41	54.2	16.56
	39	37.7	11.37	45.0	14.67	49.3	16.64	50.0	16.72	50.8	16.81	52.0	16.97	53.5	17.14
41	35.6	12.67	42.7	16.30	48.6	19.57	49.1	18.11	49.8	18.21	51.1	18.38	52.5	18.55	
43	33.7	13.21	40.6	17.00	47.8	20.62	48.2	19.26	48.9	18.90	50.2	18.85	51.6	19.02	
44	33.2	13.77	40.5	17.73	46.3	21.74	47.0	20.46	47.8	19.62	49.1	19.33	50.7	19.51	
47	31.3	18.33	39.1	23.59	44.7	22.83	45.4	20.77	46.1	20.88	47.5	20.76	49.0	20.95	
50	28.7	18.00	35.1	23.16	39.9	24.07	40.4	22.48	41.1	22.29	42.4	22.18	44.1	21.91	
52	20.8	13.35	28.0	16.62	34.7	18.70	38.2	19.64	38.4	18.99	39.3	18.74	41.5	19.24	
100%	-5	34.3	4.72	40.8	6.05	47.5	7.54	50.4	8.33	54.0	8.37	60.7	8.45	64.1	8.52
	0	34.3	4.73	40.8	6.06	47.5	7.55	50.4	8.34	54.0	8.39	60.7	8.46	64.1	8.54
	4	34.3	4.75	40.8	6.08	47.5	7.58	50.4	8.38	54.0	8.42	60.7	8.49	64.1	8.57
	7	34.3	4.84	40.8	6.19	47.5	7.72	50.4	8.53	54.0	8.57	60.7	8.65	64.1	8.73
	10	34.3	5.35	40.8	6.50	47.5	7.69	50.4	8.30	54.0	8.97	60.7	10.15	64.2	10.55
	12	34.3	5.42	40.8	6.59	47.5	7.79	50.4	8.41	54.0	9.14	60.7	10.32	63.2	10.46
	14	34.3	5.52	40.8	6.70	47.5	7.93	50.4	8.57	54.0	9.31	60.7	10.50	62.5	10.38
	16	34.3	5.64	40.8	6.85	47.5	8.10	50.4	8.76	54.0	9.52	60.5	10.74	61.6	10.61
	18	34.3	5.77	40.8	7.01	47.5	8.26	50.4	8.93	54.0	9.70	59.6	10.95	60.9	11.11
	20	34.3	5.85	40.8	7.11	47.5	8.53	50.4	9.40	54.0	10.32	58.7	11.52	60.0	11.70
	21	34.3	5.91	40.8	7.18	47.5	8.82	50.4	9.72	54.0	10.67	58.4	11.91	59.6	12.02
	23	34.3	6.07	40.8	7.68	47.5	9.49	50.4	10.45	54.0	11.48	57.7	12.61	58.7	12.72
	25	34.3	6.45	40.8	8.17	47.5	10.09	50.4	11.12	54.0	12.27	56.7	13.07	58.0	13.18
	27	34.3	6.89	40.8	8.72	47.5	10.83	50.4	11.93	54.0	13.17	55.8	13.52	57.1	13.65
	29	34.3	7.30	40.8	9.32	47.5	11.58	50.4	12.76	53.8	13.95	55.1	14.18	56.3	14.30
	31	34.3	7.77	40.8	9.93	47.5	12.35	50.4	13.75	53.2	14.52	53.8	14.75	55.5	14.89
	33	34.3	8.26	40.8	10.57	47.5	13.17	50.4	14.55	52.2	15.04	53.5	15.18	54.7	15.31
	35	34.3	8.79	40.8	11.26	47.5	14.04	50.4	15.51	51.3	15.59	52.5	15.73	53.8	15.87
	37	34.3	9.36	40.8	11.99	47.5	14.95	49.8	16.07	50.7	16.15	51.8	16.26	53.0	16.41
	39	34.3	9.97	40.8	12.77	47.5	15.92	49.2	16.60	49.4	16.68	51.1	16.80	51.8	16.95
41	32.4	11.08	38.7	14.18	45.1	17.69	48.2	17.99	48.8	18.08	50.0	18.24	51.3	18.41	
43	30.6	11.55	36.8	14.80	44.0	18.64	47.3	19.12	48.1	18.77	48.9	18.71	50.8	18.88	
44	30.1	12.04	36.7	15.42	43.0	19.65	46.2	20.32	46.8	19.48	48.1	19.19	49.5	19.36	
47	28.4	16.03	35.5	20.52	41.6	20.63	44.6	20.63	45.1	20.73	46.5	20.60	47.9	20.79	
50	26.0	15.74	31.8	20.15	37.1	21.76	39.7	22.33	40.3	22.13	41.5	22.02	43.0	21.74	
52	20.5	12.15	27.6	15.13	34.1	17.03	37.5	17.88	37.7	17.29	38.6	17.05	40.8	17.51	

TC—Total capacity of outdoor unit; PI—Power input of outdoor unit															
Combination	Outdoor air temp (°C DB)	Indoor air temp													
		14.0°C WB		16.0°C WB		18.0°C WB		19.0°C WB		20.0°C WB		22.0°C WB		24.0°C WB	
		20.0°C DB		23.0°C DB		26.0°C DB		27.0°C DB		28.0°C DB		30.0°C DB		32.0°C DB	
		TC	PI	TC	PI	TC	PI	TC	PI	TC	PI	TC	PI	TC	PI
		kW	kW	kW	kW	kW	kW	kW	kW	kW	kW	kW	kW	kW	
90%	-5	30.8	4.12	36.7	5.21	42.7	6.44	45.7	7.11	48.6	7.82	54.6	8.37	60.5	8.45
	0	30.8	4.13	36.7	5.22	42.7	6.45	45.7	7.13	48.6	7.84	54.6	8.39	60.5	8.46
	4	30.8	4.14	36.7	5.24	42.7	6.47	45.7	7.15	48.6	7.87	54.6	8.42	60.5	8.49
	7	30.8	4.22	36.7	5.34	42.7	6.59	45.7	7.29	48.6	8.01	54.6	8.57	60.5	8.65
	10	30.8	4.67	36.7	5.61	42.7	6.57	45.7	7.40	48.6	7.88	54.6	9.02	60.5	10.22
	12	30.8	4.73	36.7	5.68	42.7	6.65	45.7	7.50	48.6	8.03	54.6	9.18	60.5	10.36
	14	30.8	4.81	36.7	5.78	42.7	6.77	45.7	7.61	48.6	8.17	54.6	9.34	60.5	10.53
	16	30.8	4.92	36.7	5.91	42.7	6.92	45.7	7.78	48.6	8.35	54.6	9.55	60.3	10.73
	18	30.8	5.03	36.7	6.04	42.7	7.05	45.7	7.93	48.6	8.51	54.6	9.77	59.8	11.12
	20	30.8	5.11	36.7	6.13	42.7	7.29	45.7	8.09	48.6	8.87	54.6	10.50	58.7	11.58
	21	30.8	5.16	36.7	6.20	42.7	7.54	45.7	8.36	48.6	9.17	54.6	10.86	58.4	11.84
	23	30.8	5.29	36.7	6.62	42.7	8.10	45.7	8.99	48.6	9.82	54.6	11.66	57.5	12.45
	25	30.8	5.63	36.7	7.04	42.7	8.62	45.7	9.60	48.6	10.50	54.6	12.47	56.7	12.96
	27	30.8	6.01	36.7	7.52	42.7	9.25	45.7	10.24	48.6	11.24	54.6	13.31	55.8	13.53
	29	30.8	6.37	36.7	8.04	42.7	9.89	45.7	10.94	48.6	12.00	54.0	13.95	55.1	14.08
	31	30.8	6.78	36.7	8.56	42.7	10.55	45.7	11.68	48.6	12.81	53.1	14.46	54.2	14.65
	33	30.8	7.21	36.7	9.12	42.7	11.24	45.7	12.42	48.6	13.62	52.4	15.04	53.5	15.18
	35	30.8	7.67	36.7	9.71	42.7	11.99	45.7	13.25	48.6	14.57	51.5	15.59	52.6	15.73
	37	30.8	8.17	36.7	10.34	42.7	12.77	44.9	13.72	48.6	15.59	50.6	16.15	51.8	16.11
	39	30.8	8.70	36.7	11.01	42.7	13.60	44.3	14.18	48.6	16.53	49.8	16.75	50.9	16.70
41	29.1	9.66	34.9	12.23	40.6	15.10	43.4	15.36	46.2	16.90	49.0	18.08	50.1	18.25	
43	27.5	10.08	33.1	12.75	39.5	15.93	42.6	16.33	45.3	17.55	48.2	18.55	49.3	18.74	
44	27.1	10.51	33.0	13.30	38.7	16.78	41.6	17.35	44.4	18.21	47.2	19.02	48.4	19.19	
47	25.6	13.98	31.9	17.70	37.4	17.62	40.1	17.62	42.8	19.38	45.6	20.42	46.8	20.61	
50	23.4	13.73	28.6	17.38	33.4	18.58	35.8	19.07	38.2	20.69	40.7	21.83	42.1	21.55	
52	18.4	11.33	24.8	14.11	30.7	15.88	33.8	16.67	33.9	16.12	35.2	15.90	36.7	16.33	
80%	-5	27.4	3.56	32.6	4.39	38.0	5.46	40.6	6.01	43.1	6.56	48.6	7.79	53.8	8.35
	0	27.4	3.56	32.6	4.40	38.0	5.47	40.6	6.02	43.1	6.58	48.6	7.81	53.8	8.36
	4	27.4	3.58	32.6	4.41	38.0	5.49	40.6	6.04	43.1	6.60	48.6	7.83	53.8	8.39
	7	27.4	3.64	32.6	4.50	38.0	5.59	40.6	6.15	43.1	6.72	48.6	7.98	53.8	8.55
	10	27.4	4.24	32.6	5.08	38.0	5.98	40.6	6.44	43.2	6.89	48.6	7.88	53.8	9.15
	12	27.4	4.31	32.6	5.16	38.0	6.08	40.6	6.56	43.2	7.03	48.6	8.01	53.8	9.07
	14	27.4	4.39	32.6	5.27	38.0	6.19	40.6	6.67	43.2	7.16	48.6	8.15	53.8	9.28
	16	27.4	4.45	32.6	5.35	38.0	6.31	40.6	6.79	43.2	7.26	48.6	8.33	53.8	9.61
	18	27.4	4.54	32.6	5.46	38.0	6.45	40.6	6.94	43.2	7.41	48.6	8.52	53.8	10.28
	20	27.4	4.62	32.6	5.56	38.0	6.56	40.6	7.07	43.2	7.57	48.6	8.83	53.8	10.65
	21	27.4	4.66	32.6	5.60	38.0	6.63	40.6	7.15	43.2	7.74	48.6	9.15	53.8	11.41
	23	27.4	4.74	32.6	5.73	38.0	6.94	40.6	7.61	43.2	8.28	48.6	9.79	53.8	12.20
	25	27.4	4.89	32.6	6.08	38.0	7.42	40.6	8.13	43.2	8.84	48.6	10.48	53.8	13.02
	27	27.4	5.20	32.6	6.48	38.0	7.90	40.6	8.67	43.2	9.48	48.6	11.18	53.8	13.48
	29	27.4	5.54	32.6	6.90	38.0	8.42	40.6	9.24	43.1	10.11	48.6	11.94	53.8	13.97
	31	27.4	5.87	32.6	7.34	38.0	8.97	40.6	9.85	43.1	10.78	48.6	12.74	52.9	14.47
	33	27.4	6.25	32.6	8.17	38.0	9.55	40.6	10.49	43.1	11.48	48.6	13.59	52.2	15.00
	35	27.4	6.63	32.6	8.17	38.0	10.16	40.6	11.18	43.1	12.22	48.6	14.51	51.3	15.54
	37	27.4	7.02	32.6	8.80	38.0	10.81	39.9	11.91	43.1	13.02	48.6	15.45	50.6	16.12
	39	27.4	7.44	32.6	9.34	38.0	11.50	39.3	12.68	43.1	13.86	48.6	16.46	49.7	16.72
41	25.9	8.35	31.0	10.30	36.1	12.80	38.6	12.97	41.0	14.18	46.2	16.83	48.9	18.03	
43	24.5	8.70	30.1	10.75	35.2	13.48	37.9	13.79	40.1	14.72	45.3	17.26	48.1	18.49	
44	24.1	9.08	29.4	11.20	34.4	14.22	36.9	14.65	39.3	15.28	44.5	17.70	47.2	18.96	
47	22.7	12.08	28.4	14.90	33.2	14.93	35.6	14.87	37.9	16.26	43.0	19.01	45.7	20.36	
50	20.8	11.86	25.4	14.63	29.7	15.75	31.8	16.10	33.8	17.36	38.4	20.31	41.0	21.30	
52	16.4	9.56	22.0	11.90	27.3	13.40	30.0	14.07	30.2	13.60	30.9	13.42	32.6	13.78	

GMV6 HR DC Inverter VRF Units Technical Sales Guide

TC—Total capacity of outdoor unit; PI—Power input of outdoor unit

Combination	Outdoor air temp (°C DB)	Indoor air temp													
		14.0°C WB		16.0°C WB		18.0°C WB		19.0°C WB		20.0°C WB		22.0°C WB		24.0°C WB	
		20.0°C DB		23.0°C DB		26.0°C DB		27.0°C DB		28.0°C DB		30.0°C DB		32.0°C DB	
		TC	PI	TC	PI	TC	PI	TC	PI	TC	PI	TC	PI	TC	PI
		kW	kW	kW	kW	kW	kW	kW	kW	kW	kW	kW	kW	kW	
70%	-5	24.0	3.03	28.5	3.75	33.2	4.55	35.5	4.98	37.9	5.43	42.4	6.40	47.1	7.44
	0	24.0	3.04	28.5	3.76	33.2	4.55	35.5	4.99	37.9	5.44	42.4	6.41	47.1	7.46
	4	24.0	3.05	28.5	3.77	33.2	4.57	35.5	5.01	37.9	5.46	42.4	6.43	47.1	7.48
	7	24.0	3.10	28.5	3.84	33.2	4.66	35.5	5.10	37.9	5.56	42.4	6.55	47.1	7.62
	10	24.0	3.74	28.5	4.43	33.2	5.16	35.5	5.56	37.8	5.96	42.5	6.77	47.1	7.61
	12	24.0	3.78	28.5	4.49	33.2	5.27	35.5	5.66	37.8	6.06	42.5	6.90	47.1	7.75
	14	24.0	3.85	28.5	4.58	33.2	5.35	35.5	5.75	37.8	6.17	42.5	7.02	47.1	7.90
	16	24.0	3.91	28.5	4.66	33.2	5.46	35.5	5.87	37.8	6.29	42.5	7.15	47.1	8.05
	18	24.0	3.97	28.5	4.74	33.2	5.56	35.5	5.98	37.8	6.40	42.5	7.30	47.1	8.21
	20	24.0	4.03	28.5	4.83	33.2	5.66	35.5	6.08	37.8	6.52	42.5	7.44	47.1	8.44
	21	24.0	4.08	28.5	4.87	33.2	5.71	35.5	6.15	37.8	6.58	42.5	7.53	47.1	8.74
	23	24.0	4.14	28.5	4.95	33.2	5.83	35.5	6.35	37.8	6.92	42.5	8.09	47.1	9.36
	25	24.0	4.22	28.5	5.16	33.2	6.21	35.5	6.79	37.8	7.38	42.5	8.65	47.1	10.01
	27	24.0	4.47	28.5	5.50	33.2	6.63	35.5	7.23	37.8	7.88	42.5	9.24	47.1	10.70
	29	24.0	4.74	28.5	5.83	33.2	7.04	35.5	7.71	37.8	8.38	42.5	9.85	47.1	11.43
	31	24.0	5.02	28.5	6.19	33.2	7.50	35.5	8.19	37.8	8.93	42.5	10.49	47.1	12.19
	33	24.0	5.33	28.5	6.58	33.2	7.98	35.5	8.72	37.8	9.51	42.5	11.18	47.1	13.00
	35	24.0	5.64	28.5	6.98	33.2	8.47	35.5	9.28	37.8	10.12	42.5	11.91	47.1	13.86
	37	24.0	5.96	28.5	7.40	33.2	9.01	34.9	9.87	37.8	10.77	42.5	12.69	47.1	14.76
	39	24.0	6.31	28.5	7.84	33.2	9.55	34.4	10.47	37.8	11.43	42.5	13.48	47.1	15.72
41	22.7	7.11	27.1	8.80	31.6	10.67	33.8	10.77	36.0	11.74	40.5	13.82	44.9	16.08	
43	21.4	7.41	26.3	9.18	30.5	11.24	33.1	11.44	34.2	12.18	39.7	14.17	43.7	16.49	
44	21.1	7.73	25.7	9.56	30.1	11.85	32.3	12.16	34.5	12.65	38.9	14.54	43.4	16.91	
47	19.9	10.29	24.8	12.73	29.1	12.44	31.2	12.34	33.3	13.46	37.6	15.61	41.9	18.15	
50	18.2	10.10	22.3	12.50	26.0	13.12	27.8	13.36	29.7	14.37	33.6	16.68	37.7	18.99	
52	14.3	7.94	19.3	9.88	23.9	11.02	26.3	11.67	26.4	11.29	27.0	11.14	28.5	11.43	
60%	-5	20.6	2.55	24.5	3.11	28.5	3.73	30.5	4.06	32.4	4.41	36.4	5.15	40.4	5.95
	0	20.6	2.55	24.5	3.12	28.5	3.73	30.5	4.07	32.4	4.42	36.4	5.16	40.4	5.96
	4	20.6	2.56	24.5	3.13	28.5	3.75	30.5	4.09	32.4	4.44	36.4	5.18	40.4	5.98
	7	20.6	2.61	24.5	3.18	28.5	3.82	30.5	4.16	32.4	4.52	36.4	5.28	40.4	6.09
	10	20.6	3.24	24.5	3.80	28.5	4.41	30.5	4.72	32.4	5.04	36.4	5.71	40.4	6.40
	12	20.6	3.30	24.5	3.87	28.5	4.49	30.5	4.81	32.4	5.12	36.4	5.81	40.4	6.50
	14	20.6	3.34	24.5	3.93	28.5	4.56	30.5	4.89	32.4	5.23	36.4	5.92	40.4	6.63
	16	20.6	3.39	24.5	3.99	28.5	4.64	30.5	4.97	32.4	5.31	36.4	6.02	40.4	6.75
	18	20.6	3.45	24.5	4.06	28.5	4.72	30.5	5.06	32.4	5.41	36.4	6.12	40.4	6.88
	20	20.6	3.49	24.5	4.14	28.5	4.81	30.5	5.16	32.4	5.52	36.4	6.25	40.4	7.02
	21	20.6	3.53	24.5	4.16	28.5	4.85	30.5	5.20	32.4	5.56	36.4	6.31	40.4	7.09
	23	20.6	3.57	24.5	4.24	28.5	4.93	30.5	5.31	32.4	5.66	36.4	6.56	40.4	7.55
	25	20.6	3.64	24.5	4.33	28.5	5.12	30.5	5.56	32.4	6.02	36.4	7.00	40.4	8.05
	27	20.6	3.78	24.5	4.58	28.5	5.46	30.5	5.94	32.4	6.42	36.4	7.46	40.4	8.59
	29	20.6	3.99	24.5	4.85	28.5	5.81	30.5	6.31	32.4	6.84	36.4	7.96	40.4	9.18
	31	20.6	4.24	24.5	5.16	28.5	6.17	30.5	6.71	32.4	7.27	36.4	8.47	40.4	9.76
	33	20.6	4.47	24.5	5.46	28.5	6.54	30.5	7.13	32.4	7.73	36.4	9.01	40.4	10.41
	35	20.6	4.74	24.5	5.79	28.5	6.94	30.5	7.57	32.4	8.21	36.4	9.59	40.4	11.08
	37	20.6	5.02	24.5	6.12	28.5	7.36	29.9	8.03	32.4	8.72	36.4	10.20	40.4	11.79
	39	20.6	5.29	24.5	6.48	28.5	7.80	29.5	8.51	32.4	9.26	36.4	10.83	40.4	12.54
41	19.4	5.98	23.2	7.30	27.1	8.74	28.9	8.78	30.8	9.53	34.7	11.13	38.5	12.85	
43	18.4	6.23	22.1	7.60	26.3	9.22	28.4	9.33	29.9	9.89	34.3	11.41	37.7	13.19	
44	18.1	6.50	22.0	7.93	25.8	9.72	27.7	9.91	29.6	10.27	33.4	11.71	37.2	13.52	
47	17.1	8.65	21.3	10.56	24.9	10.20	26.7	10.06	28.5	10.93	32.2	12.57	36.0	14.51	
50	15.6	8.49	19.1	10.36	22.3	10.76	23.8	10.90	25.4	11.67	28.8	13.43	32.3	15.18	
52	12.3	6.47	16.5	8.06	20.4	9.06	22.5	9.52	22.6	9.20	23.2	9.08	24.5	9.32	

TC—Total capacity of outdoor unit; PI—Power input of outdoor unit															
Combination	Outdoor air temp (°C DB)	Indoor air temp													
		14.0°C WB		16.0°C WB		18.0°C WB		19.0°C WB		20.0°C WB		22.0°C WB		24.0°C WB	
		20.0°C DB		23.0°C DB		26.0°C DB		27.0°C DB		28.0°C DB		30.0°C DB		32.0°C DB	
		TC	PI	TC	PI	TC	PI	TC	PI	TC	PI	TC	PI	TC	PI
		kW	kW	kW	kW	kW	kW	kW	kW	kW	kW	kW	kW	kW	
50%	-5	17.1	2.11	20.4	2.53	23.7	2.99	25.4	3.23	27.0	3.49	30.4	4.04	33.7	4.62
	0	17.1	2.11	20.4	2.53	23.7	2.99	25.4	3.24	27.0	3.50	30.4	4.05	33.7	4.63
	4	17.1	2.12	20.4	2.54	23.7	3.00	25.4	3.25	27.0	3.51	30.4	4.06	33.7	4.65
	7	17.1	2.16	20.4	2.59	23.7	3.06	25.4	3.31	27.0	3.58	30.4	4.14	33.7	4.74
	10	17.1	2.80	20.4	3.24	23.7	3.70	25.4	3.95	27.0	4.18	30.4	4.70	33.7	5.25
	12	17.1	2.82	20.4	3.28	23.7	3.76	25.4	3.99	27.0	4.26	30.4	4.79	33.7	5.33
	14	17.1	2.86	20.4	3.32	23.7	3.80	25.4	4.08	27.0	4.33	30.4	4.87	33.7	5.43
	16	17.1	2.91	20.4	3.37	23.7	3.87	25.4	4.14	27.0	4.39	30.4	4.95	33.7	5.52
	18	17.1	2.95	20.4	3.43	23.7	3.93	25.4	4.20	27.0	4.47	30.4	5.04	33.7	5.62
	20	17.1	2.99	20.4	3.47	23.7	3.99	25.4	4.29	27.0	4.56	30.4	5.14	33.7	5.73
	21	17.1	3.01	20.4	3.51	23.7	4.03	25.4	4.31	27.0	4.60	30.4	5.18	33.7	5.79
	23	17.1	3.05	20.4	3.55	23.7	4.10	25.4	4.39	27.0	4.68	30.4	5.27	33.7	5.92
	25	17.1	3.09	20.4	3.62	23.7	4.18	25.4	4.47	27.0	4.83	30.4	5.54	33.7	6.31
	27	17.1	3.16	20.4	3.76	23.7	4.41	25.4	4.77	27.0	5.12	30.4	5.89	33.7	6.73
	29	17.1	3.32	20.4	3.97	23.7	4.68	25.4	5.06	26.9	5.46	30.4	6.27	33.7	7.17
	31	17.1	3.51	20.4	4.20	23.7	5.00	25.4	5.37	26.9	5.79	30.4	6.67	33.7	7.63
	33	17.1	3.72	20.4	4.45	23.7	5.27	25.4	5.69	26.9	6.15	30.4	7.09	33.7	8.11
	35	17.1	3.93	20.4	4.70	23.7	5.56	25.4	6.02	26.9	6.50	30.4	7.53	33.7	8.61
	37	17.1	4.14	20.4	4.97	23.7	5.89	24.9	6.38	26.9	6.90	30.4	7.98	33.7	9.16
	39	17.1	4.37	20.4	5.25	23.7	6.23	24.6	6.75	26.9	7.32	30.4	8.47	33.7	9.72
41	16.2	4.95	19.4	5.93	22.6	7.01	24.1	6.98	25.6	7.54	28.9	8.73	32.1	9.99	
43	15.3	5.17	18.4	6.22	21.9	7.38	23.7	7.48	25.2	7.83	28.1	8.95	31.4	10.25	
44	15.1	5.38	18.4	6.44	21.5	7.78	23.1	7.89	24.6	8.13	27.8	9.18	31.0	10.51	
47	14.2	7.16	17.7	8.57	20.8	8.17	22.3	8.01	23.7	8.65	26.9	9.86	30.0	11.28	
50	13.0	7.03	15.9	8.42	18.5	8.62	19.9	8.67	21.1	9.23	24.0	10.54	27.0	11.80	
52	10.2	5.15	13.8	6.41	17.0	7.21	18.8	7.57	18.9	7.32	19.3	7.22	20.4	7.42	

GMV-VQ560WM/C-X

TC—Total capacity of outdoor unit; PI—Power input of outdoor unit															
Combination	Outdoor air temp (°C DB)	Indoor air temp													
		14.0°C WB		16.0°C WB		18.0°C WB		19.0°C WB		20.0°C WB		22.0°C WB		24.0°C WB	
		20.0°C DB		23.0°C DB		26.0°C DB		27.0°C DB		28.0°C DB		30.0°C DB		32.0°C DB	
		TC	PI	TC	PI	TC	PI	TC	PI	TC	PI	TC	PI	TC	PI
		kW	kW	kW	kW	kW	kW	kW	kW	kW	kW	kW	kW	kW	
135%	-5	49.5	8.84	59.0	10.77	68.5	10.90	71.1	10.96	72.4	11.02	74.2	11.15	76.1	11.26
	0	49.5	8.86	59.0	10.79	68.5	10.92	71.1	10.98	72.4	11.04	74.2	11.17	76.1	11.28
	4	49.5	8.89	59.0	10.83	68.5	10.96	71.1	11.02	72.4	11.08	74.2	11.21	76.1	11.32
	7	49.5	9.06	59.0	11.03	68.5	11.16	71.1	11.22	72.4	11.28	74.2	11.42	76.1	11.53
	10	49.5	9.22	59.0	11.27	68.5	13.40	71.1	13.69	71.9	13.42	73.7	12.86	75.5	12.26
	12	49.5	9.38	59.0	11.48	68.5	13.67	70.1	13.61	71.1	13.34	72.7	12.75	74.5	12.56
	14	49.5	9.57	59.0	11.70	68.3	13.83	69.3	13.56	70.1	13.26	71.9	13.15	73.7	13.29
	16	49.5	9.73	59.0	11.94	67.5	13.77	68.3	13.67	69.1	13.72	70.9	13.85	72.7	13.99
	18	49.5	9.92	59.0	12.18	66.5	14.29	67.3	14.37	68.3	14.45	70.1	14.58	71.9	14.72
	20	49.5	10.13	59.0	12.96	65.5	14.99	66.5	15.07	67.3	15.15	69.1	15.28	70.9	15.44
	21	49.5	10.40	59.0	13.42	65.1	15.34	66.1	15.42	66.9	15.50	68.7	15.66	70.5	15.80
	23	49.5	11.16	59.0	14.39	64.2	16.04	65.1	16.12	65.9	16.20	67.7	16.36	69.5	16.52
	25	49.5	11.91	59.0	15.42	63.2	16.74	64.2	16.82	65.1	16.93	66.9	17.09	68.7	17.25
	27	49.5	12.72	59.0	16.50	62.4	17.44	63.2	17.55	64.0	17.63	65.9	17.82	67.7	18.01
	29	49.5	13.58	59.0	17.63	61.4	18.14	62.2	18.25	63.2	18.36	65.1	18.54	66.9	18.73
	31	49.5	14.50	58.8	18.65	60.4	18.87	61.4	18.98	62.2	19.06	64.0	19.27	65.9	19.49
	33	49.5	15.44	57.8	19.35	59.6	19.54	60.4	19.68	61.4	19.78	63.2	20.00	64.9	20.24
	35	49.5	16.47	56.8	20.05	58.6	20.30	59.6	20.40	60.4	20.51	62.2	20.75	64.0	20.97
	37	49.5	17.52	56.0	20.78	57.8	21.02	58.6	21.13	59.6	21.27	61.2	21.51	63.0	21.75
	39	49.5	18.65	55.0	21.48	56.8	21.73	57.8	21.86	58.6	21.99	60.4	22.24	62.2	22.51
41	46.8	20.75	54.0	25.27	55.7	25.57	56.7	23.67	57.5	23.79	59.2	24.08	61.0	24.33	
43	44.2	21.64	52.9	26.34	54.6	26.96	55.5	25.16	56.3	24.70	58.1	24.68	59.9	24.94	
44	43.6	22.56	51.1	27.47	53.0	28.42	54.2	26.73	55.2	25.64	57.0	25.32	58.9	25.58	
47	41.1	30.02	49.4	36.56	51.3	29.84	52.3	27.14	53.2	27.28	55.1	27.19	57.0	27.47	
50	37.7	29.48	44.3	35.90	45.8	31.46	46.7	29.38	47.4	29.13	49.2	29.06	51.2	28.73	
52	24.1	17.45	32.4	21.72	40.0	24.44	44.1	25.66	44.3	24.82	45.3	24.48	47.9	25.14	

GMV6 HR DC Inverter VRF Units Technical Sales Guide

TC—Total capacity of outdoor unit; PI—Power input of outdoor unit

Combination	Outdoor air temp (°C DB)	Indoor air temp													
		14.0°C WB		16.0°C WB		18.0°C WB		19.0°C WB		20.0°C WB		22.0°C WB		24.0°C WB	
		20.0°C DB		23.0°C DB		26.0°C DB		27.0°C DB		28.0°C DB		30.0°C DB		32.0°C DB	
		TC	PI	TC	PI	TC	PI	TC	PI	TC	PI	TC	PI	TC	PI
		kW	kW	kW	kW	kW	kW	kW	kW	kW	kW	kW	kW	kW	
120%	-5	45.7	7.87	54.4	10.19	63.2	10.83	67.7	10.88	71.2	10.94	72.8	11.06	74.4	11.17
	0	45.7	7.89	54.4	10.21	63.2	10.85	67.7	10.91	71.2	10.96	72.8	11.08	74.4	11.20
	4	45.7	7.92	54.4	10.25	63.2	10.89	67.7	10.95	71.2	11.00	72.8	11.12	74.4	11.24
	7	45.7	8.06	54.4	10.44	63.2	11.09	67.7	11.15	71.2	11.21	72.8	11.33	74.4	11.44
	10	45.7	8.41	54.4	10.27	63.2	12.21	67.7	13.21	70.9	13.77	72.5	13.23	74.1	12.72
	12	45.7	8.57	54.4	10.46	63.2	12.45	67.7	13.45	69.9	13.69	71.5	13.18	73.1	12.64
	14	45.7	8.73	54.4	10.67	63.2	12.70	67.7	13.72	68.9	13.61	70.7	13.10	72.3	13.18
	16	45.7	8.89	54.4	10.89	63.2	12.94	67.3	13.83	68.1	13.64	69.7	13.77	71.3	13.88
	18	45.7	9.06	54.4	11.11	63.2	13.40	66.3	14.29	67.1	14.34	68.7	14.47	70.5	14.61
	20	45.7	9.25	54.4	11.54	63.2	14.39	65.5	14.99	66.3	15.04	67.9	15.18	69.5	15.31
	21	45.7	9.33	54.4	11.94	63.2	14.91	64.9	15.34	65.7	15.39	67.5	15.53	69.1	15.69
	23	45.7	9.97	54.4	12.80	63.2	15.96	64.0	16.01	64.9	16.09	66.5	16.25	68.1	16.39
	25	45.7	10.65	54.4	13.69	62.2	16.66	63.0	16.71	63.8	16.79	65.7	16.95	67.3	17.12
	27	45.7	11.37	54.4	14.64	61.4	17.33	62.2	17.44	63.0	17.52	64.6	17.68	66.3	17.84
	29	45.7	12.13	54.4	15.63	60.4	18.03	61.2	18.14	62.0	18.22	63.6	18.41	65.5	18.57
	31	45.7	12.94	54.4	16.68	59.6	18.76	60.4	18.84	61.2	18.95	62.8	19.14	64.4	19.33
	33	45.7	13.77	54.4	17.82	58.6	19.46	59.4	19.57	60.2	19.65	61.8	19.87	63.4	20.05
	35	45.7	14.66	54.4	18.98	57.6	20.16	58.4	20.27	59.4	20.38	61.0	20.59	62.6	20.81
	37	45.7	15.61	54.4	20.22	56.8	20.89	57.6	21.00	58.4	21.11	60.0	21.32	61.6	21.56
	39	45.7	16.60	54.2	21.35	55.8	21.59	56.6	21.73	57.4	21.83	59.2	22.08	60.8	22.29
41	43.2	18.48	51.7	23.91	54.7	25.40	55.5	23.51	56.5	23.64	58.1	23.89	59.7	24.14	
43	40.8	19.26	49.3	24.92	53.7	26.77	54.5	24.98	55.6	24.54	57.0	24.49	58.6	24.76	
44	40.2	20.09	48.9	26.00	52.1	28.23	53.1	26.55	54.2	25.47	55.9	25.12	57.6	25.39	
47	37.9	26.73	47.3	34.59	50.4	29.64	51.3	26.96	52.3	27.10	54.0	26.98	55.7	27.26	
50	34.7	26.25	42.4	33.97	45.0	31.25	45.7	29.19	46.6	28.94	48.2	28.83	50.1	28.51	
52	23.6	17.33	31.7	21.58	39.2	24.28	43.2	25.49	43.4	24.65	44.4	24.32	46.9	24.97	
110%	-5	41.9	6.96	49.9	8.96	58.0	10.75	62.0	10.81	66.1	10.87	71.2	10.97	72.7	11.07
	0	41.9	6.98	49.9	8.98	58.0	10.77	62.0	10.83	66.1	10.89	71.2	10.99	72.7	11.09
	4	41.9	7.00	49.9	9.01	58.0	10.81	62.0	10.87	66.1	10.93	71.2	11.03	72.7	11.13
	7	41.9	7.13	49.9	9.18	58.0	11.01	62.0	11.07	66.1	11.13	71.2	11.24	72.7	11.34
	10	41.9	7.63	49.9	9.30	58.0	11.05	62.0	11.94	66.1	12.86	71.1	13.64	72.7	13.18
	12	41.9	7.79	49.9	9.49	58.0	11.27	62.0	12.18	66.1	13.10	70.3	13.58	71.7	13.10
	14	41.9	7.92	49.9	9.65	58.0	11.48	62.0	12.40	66.1	13.34	69.3	13.58	70.9	13.07
	16	41.9	8.06	49.9	9.84	58.0	11.70	62.0	12.64	66.1	13.61	68.5	13.67	69.9	13.80
	18	41.9	8.22	49.9	10.03	58.0	11.94	62.0	12.99	66.1	14.26	67.5	14.37	69.1	14.50
	20	41.9	8.38	49.9	10.24	58.0	12.64	62.0	13.96	65.1	14.96	66.7	15.07	68.1	15.20
	21	41.9	8.46	49.9	10.54	58.0	13.10	62.0	14.47	64.6	15.31	66.1	15.42	67.7	15.55
	23	41.9	8.87	49.9	11.29	58.0	14.04	62.0	15.53	63.6	15.98	65.3	16.15	66.7	16.28
	25	41.9	9.43	49.9	12.08	58.0	15.01	62.0	16.63	62.8	16.68	64.2	16.85	65.9	16.98
	27	41.9	10.08	49.9	12.91	58.0	16.06	61.0	17.33	61.8	17.39	63.4	17.55	64.9	17.71
	29	41.9	10.75	49.9	13.77	58.0	17.17	60.2	18.03	61.0	18.11	62.4	18.27	64.0	18.44
	31	41.9	11.46	49.9	14.69	58.0	18.33	59.2	18.73	60.0	18.81	61.6	18.98	63.0	19.16
	33	41.9	12.18	49.9	15.66	57.6	19.33	58.4	19.43	59.2	19.51	60.6	19.70	62.2	19.89
	35	41.9	12.96	49.9	16.68	56.8	20.03	57.4	20.13	58.2	20.24	59.6	20.43	61.2	20.62
	37	41.9	13.80	49.9	17.76	55.8	20.75	56.6	20.84	57.2	20.94	58.8	21.16	60.2	21.35
	39	41.9	14.66	49.9	18.92	54.8	21.46	55.6	21.56	56.4	21.67	57.8	21.89	59.4	22.10
41	39.6	16.34	47.4	21.02	54.0	25.23	54.6	23.36	55.4	23.48	56.8	23.70	58.3	23.92	
43	37.4	17.03	45.1	21.92	53.2	26.59	53.5	24.83	54.3	24.38	55.7	24.30	57.3	24.52	
44	36.9	17.76	45.0	22.86	51.4	28.04	52.2	26.38	53.1	25.30	54.6	24.93	56.3	25.16	
47	34.8	23.64	43.5	30.42	49.7	29.44	50.4	26.78	51.2	26.92	52.8	26.76	54.5	27.01	
50	31.8	23.21	39.0	29.87	44.4	31.04	44.9	28.99	45.7	28.74	47.1	28.60	49.0	28.25	
52	23.2	17.22	31.2	21.43	38.5	24.12	42.4	25.32	42.6	24.49	43.7	24.16	46.1	24.81	

TC—Total capacity of outdoor unit; PI—Power input of outdoor unit															
Combination	Outdoor air temp (°C DB)	Indoor air temp													
		14.0°C WB		16.0°C WB		18.0°C WB		19.0°C WB		20.0°C WB		22.0°C WB		24.0°C WB	
		20.0°C DB		23.0°C DB		26.0°C DB		27.0°C DB		28.0°C DB		30.0°C DB		32.0°C DB	
		TC	PI	TC	PI	TC	PI	TC	PI	TC	PI	TC	PI	TC	PI
		kW	kW	kW	kW	kW	kW	kW	kW	kW	kW	kW	kW	kW	
100%	-5	38.1	6.09	45.3	7.80	52.8	9.72	56.0	10.74	60.0	10.79	67.5	10.89	71.3	10.99
	0	38.1	6.10	45.3	7.81	52.8	9.74	56.0	10.76	60.0	10.81	67.5	10.91	71.3	11.01
	4	38.1	6.12	45.3	7.84	52.8	9.77	56.0	10.80	60.0	10.85	67.5	10.95	71.3	11.05
	7	38.1	6.24	45.3	7.98	52.8	9.95	56.0	11.00	60.0	11.06	67.5	11.15	71.3	11.25
	10	38.1	6.90	45.3	8.38	52.8	9.92	56.0	10.71	60.0	11.56	67.4	13.08	71.3	13.60
	12	38.1	6.99	45.3	8.49	52.8	10.05	56.0	10.85	60.0	11.79	67.4	13.31	70.3	13.49
	14	38.1	7.11	45.3	8.64	52.8	10.22	56.0	11.05	60.0	12.00	67.4	13.54	69.5	13.38
	16	38.1	7.27	45.3	8.84	52.8	10.45	56.0	11.29	60.0	12.27	67.2	13.85	68.5	13.68
	18	38.1	7.44	45.3	9.03	52.8	10.65	56.0	11.51	60.0	12.51	66.3	14.11	67.7	14.33
	20	38.1	7.55	45.3	9.17	52.8	11.00	56.0	12.12	60.0	13.31	65.2	14.86	66.7	15.08
	21	38.1	7.63	45.3	9.26	52.8	11.38	56.0	12.53	60.0	13.76	64.9	15.36	66.3	15.50
	23	38.1	7.82	45.3	9.90	52.8	12.24	56.0	13.48	60.0	14.80	64.1	16.26	65.2	16.40
	25	38.1	8.32	45.3	10.53	52.8	13.02	56.0	14.34	60.0	15.83	63.0	16.85	64.5	17.00
	27	38.1	8.89	45.3	11.25	52.8	13.97	56.0	15.38	60.0	16.98	62.0	17.44	63.4	17.60
	29	38.1	9.42	45.3	12.02	52.8	14.94	56.0	16.45	59.8	17.99	61.2	18.28	62.6	18.45
	31	38.1	10.02	45.3	12.80	52.8	15.93	56.0	17.73	59.1	18.72	59.8	19.02	61.6	19.19
	33	38.1	10.66	45.3	13.63	52.8	16.98	56.0	18.76	58.0	19.40	59.5	19.57	60.8	19.75
	35	38.1	11.34	45.3	14.52	52.8	18.10	56.0	20.00	57.0	20.10	58.4	20.28	59.8	20.46
	37	38.1	12.07	45.3	15.46	52.8	19.28	55.4	20.72	56.3	20.82	57.5	20.97	58.9	21.16
	39	38.1	12.86	45.3	16.46	52.8	20.53	54.6	21.40	54.9	21.51	56.8	21.66	57.5	21.86
41	36.0	14.28	43.0	18.29	50.1	22.81	53.6	23.20	54.2	23.32	55.6	23.53	57.0	23.74	
43	34.0	14.89	40.9	19.08	48.9	24.04	52.6	24.66	53.5	24.20	54.4	24.13	56.4	24.35	
44	33.5	15.53	40.8	19.89	47.8	25.34	51.3	26.20	52.0	25.13	53.5	24.74	55.0	24.97	
47	31.6	20.67	39.4	26.46	46.2	26.61	49.5	26.60	50.2	26.73	51.7	26.57	53.2	26.81	
50	28.9	20.29	35.3	25.98	41.2	28.06	44.2	28.80	44.7	28.54	46.1	28.39	47.8	28.03	
52	22.8	15.67	30.6	19.51	37.9	21.96	41.7	23.05	41.9	22.29	42.9	21.99	45.3	22.58	
90%	-5	34.3	5.31	40.8	6.72	47.5	8.30	50.8	9.17	54.0	10.09	60.6	10.80	67.3	10.89
	0	34.3	5.32	40.8	6.74	47.5	8.32	50.8	9.19	54.0	10.11	60.6	10.82	67.3	10.91
	4	34.3	5.34	40.8	6.76	47.5	8.35	50.8	9.22	54.0	10.15	60.6	10.86	67.3	10.95
	7	34.3	5.44	40.8	6.89	47.5	8.50	50.8	9.39	54.0	10.33	60.6	11.06	67.3	11.16
	10	34.3	6.02	40.8	7.23	47.5	8.47	50.8	9.54	54.0	10.16	60.7	11.64	67.2	13.18
	12	34.3	6.10	40.8	7.33	47.5	8.58	50.8	9.67	54.0	10.35	60.7	11.84	67.2	13.36
	14	34.3	6.21	40.8	7.45	47.5	8.73	50.8	9.81	54.0	10.53	60.7	12.04	67.2	13.57
	16	34.3	6.34	40.8	7.62	47.5	8.92	50.8	10.03	54.0	10.77	60.7	12.31	67.0	13.84
	18	34.3	6.49	40.8	7.79	47.5	9.10	50.8	10.23	54.0	10.98	60.7	12.60	66.4	14.34
	20	34.3	6.59	40.8	7.91	47.5	9.40	50.8	10.44	54.0	11.43	60.7	13.54	65.3	14.94
	21	34.3	6.65	40.8	7.99	47.5	9.72	50.8	10.78	54.0	11.83	60.7	14.00	64.9	15.27
	23	34.3	6.82	40.8	8.54	47.5	10.45	50.8	11.60	54.0	12.66	60.7	15.04	63.8	16.06
	25	34.3	7.26	40.8	9.08	47.5	11.12	50.8	12.38	54.0	13.54	60.7	16.08	63.0	16.71
	27	34.3	7.76	40.8	9.70	47.5	11.93	50.8	13.21	54.0	14.50	60.7	17.16	62.0	17.44
	29	34.3	8.22	40.8	10.37	47.5	12.76	50.8	14.11	54.0	15.47	60.0	17.99	61.2	18.15
	31	34.3	8.74	40.8	11.04	47.5	13.60	50.8	15.06	54.0	16.51	59.0	18.64	60.2	18.89
	33	34.3	9.30	40.8	11.76	47.5	14.50	50.8	16.02	54.0	17.57	58.2	19.40	59.4	19.57
	35	34.3	9.89	40.8	12.52	47.5	15.46	50.8	17.08	54.0	18.79	57.2	20.10	58.4	20.28
	37	34.3	10.53	40.8	13.33	47.5	16.46	49.8	17.69	54.0	20.10	56.2	20.83	57.6	20.77
	39	34.3	11.22	40.8	14.20	47.5	17.53	49.2	18.28	54.0	21.31	55.4	21.60	56.6	21.54
41	32.4	12.46	38.7	15.78	45.1	19.48	48.2	19.81	51.4	21.79	54.5	23.32	55.7	23.53	
43	30.6	12.99	36.8	16.44	43.9	20.54	47.3	21.05	50.4	22.63	53.5	23.91	54.7	24.17	
44	30.1	13.55	36.7	17.15	43.0	21.64	46.2	22.37	49.3	23.49	52.4	24.53	53.7	24.75	
47	28.4	18.03	35.5	22.82	41.6	22.72	44.6	22.72	47.5	24.99	50.6	26.34	52.0	26.57	
50	26.0	17.71	31.8	22.41	37.1	23.96	39.7	24.60	42.4	26.68	45.2	28.14	46.7	27.79	
52	20.5	14.61	27.6	18.19	34.1	20.47	37.5	21.49	37.7	20.78	39.1	20.50	40.8	21.05	

GMV6 HR DC Inverter VRF Units Technical Sales Guide

TC—Total capacity of outdoor unit; PI—Power input of outdoor unit															
Combination	Outdoor air temp (°C DB)	Indoor air temp													
		14.0°C WB		16.0°C WB		18.0°C WB		19.0°C WB		20.0°C WB		22.0°C WB		24.0°C WB	
		20.0°C DB		23.0°C DB		26.0°C DB		27.0°C DB		28.0°C DB		30.0°C DB		32.0°C DB	
		TC	PI	TC	PI	TC	PI	TC	PI	TC	PI	TC	PI	TC	PI
		kW	kW	kW	kW	kW	kW	kW	kW	kW	kW	kW	kW	kW	
80%	-5	30.5	4.59	36.3	5.66	42.2	7.03	45.1	7.74	47.9	8.46	54.0	10.05	59.8	10.76
	0	30.5	4.60	36.3	5.67	42.2	7.05	45.1	7.76	47.9	8.48	54.0	10.07	59.8	10.78
	4	30.5	4.61	36.3	5.69	42.2	7.07	45.1	7.79	47.9	8.51	54.0	10.10	59.8	10.82
	7	30.5	4.70	36.3	5.80	42.2	7.20	45.1	7.93	47.9	8.67	54.0	10.29	59.8	11.02
	10	30.5	5.47	36.3	6.55	42.2	7.71	45.1	8.30	48.0	8.89	54.0	10.16	59.8	11.79
	12	30.5	5.55	36.3	6.66	42.2	7.84	45.1	8.46	48.0	9.06	54.0	10.33	59.8	11.70
	14	30.5	5.66	36.3	6.79	42.2	7.98	45.1	8.60	48.0	9.23	54.0	10.51	59.8	11.96
	16	30.5	5.74	36.3	6.90	42.2	8.14	45.1	8.76	48.0	9.37	54.0	10.75	59.8	12.40
	18	30.5	5.85	36.3	7.04	42.2	8.32	45.1	8.95	48.0	9.55	54.0	10.99	59.8	13.26
	20	30.5	5.96	36.3	7.17	42.2	8.46	45.1	9.11	48.0	9.76	54.0	11.39	59.8	13.74
	21	30.5	6.01	36.3	7.22	42.2	8.54	45.1	9.22	48.0	9.98	54.0	11.80	59.8	14.71
	23	30.5	6.12	36.3	7.39	42.2	8.95	45.1	9.81	48.0	10.68	54.0	12.62	59.8	15.73
	25	30.5	6.31	36.3	7.84	42.2	9.57	45.1	10.49	48.0	11.40	54.0	13.51	59.8	16.79
	27	30.5	6.71	36.3	8.36	42.2	10.19	45.1	11.19	48.0	12.23	54.0	14.42	59.8	17.38
	29	30.5	7.14	36.3	8.89	42.2	10.86	45.1	11.91	47.9	13.04	54.0	15.39	59.8	18.01
	31	30.5	7.57	36.3	9.46	42.2	11.56	45.1	12.70	47.9	13.90	54.0	16.43	58.8	18.67
	33	30.5	8.06	36.3	10.54	42.2	12.32	45.1	13.53	47.9	14.80	54.0	17.53	58.0	19.34
	35	30.5	8.54	36.3	10.54	42.2	13.10	45.1	14.42	47.9	15.76	54.0	18.71	57.0	20.04
	37	30.5	9.06	36.3	11.35	42.2	13.94	44.3	15.36	47.9	16.79	54.0	19.92	56.2	20.79
	39	30.5	9.60	36.3	12.05	42.2	14.82	43.7	16.36	47.9	17.88	54.0	21.22	55.2	21.55
41	28.8	10.77	34.4	13.28	40.1	16.51	42.9	16.73	45.5	18.28	51.4	21.70	54.3	23.25	
43	27.2	11.22	33.4	13.86	39.1	17.39	42.1	17.78	44.5	18.98	50.4	22.26	53.5	23.85	
44	26.8	11.71	32.6	14.44	38.2	18.34	41.1	18.89	43.7	19.70	49.4	22.82	52.4	24.45	
47	25.3	15.58	31.5	19.21	36.9	19.26	39.6	19.18	42.1	20.96	47.8	24.51	50.7	26.26	
50	23.1	15.29	28.3	18.86	33.0	20.30	35.3	20.76	37.6	22.38	42.6	26.19	45.6	27.46	
52	18.2	12.33	24.5	15.35	30.3	17.27	33.4	18.14	33.5	17.54	34.3	17.30	36.3	17.77	
70%	-5	26.6	3.91	31.7	4.83	36.9	5.86	39.5	6.43	42.1	7.01	47.1	8.25	52.4	9.60
	0	26.6	3.92	31.7	4.84	36.9	5.87	39.5	6.44	42.1	7.02	47.1	8.27	52.4	9.61
	4	26.6	3.93	31.7	4.86	36.9	5.89	39.5	6.46	42.1	7.04	47.1	8.30	52.4	9.65
	7	26.6	4.00	31.7	4.95	36.9	6.00	39.5	6.58	42.1	7.18	47.1	8.45	52.4	9.83
	10	26.6	4.82	31.7	5.71	36.9	6.66	39.5	7.17	42.0	7.68	47.2	8.73	52.4	9.81
	12	26.6	4.88	31.7	5.80	36.9	6.79	39.5	7.30	42.0	7.82	47.2	8.89	52.4	10.00
	14	26.6	4.96	31.7	5.90	36.9	6.90	39.5	7.41	42.0	7.95	47.2	9.06	52.4	10.19
	16	26.6	5.04	31.7	6.01	36.9	7.04	39.5	7.57	42.0	8.11	47.2	9.22	52.4	10.38
	18	26.6	5.12	31.7	6.12	36.9	7.17	39.5	7.71	42.0	8.25	47.2	9.41	52.4	10.59
	20	26.6	5.20	31.7	6.23	36.9	7.30	39.5	7.84	42.0	8.41	47.2	9.60	52.4	10.89
	21	26.6	5.26	31.7	6.28	36.9	7.36	39.5	7.92	42.0	8.49	47.2	9.70	52.4	11.27
	23	26.6	5.34	31.7	6.39	36.9	7.52	39.5	8.19	42.0	8.92	47.2	10.43	52.4	12.08
	25	26.6	5.44	31.7	6.66	36.9	8.01	39.5	8.76	42.0	9.51	47.2	11.16	52.4	12.91
	27	26.6	5.77	31.7	7.09	36.9	8.54	39.5	9.33	42.0	10.16	47.2	11.91	52.4	13.80
	29	26.6	6.12	31.7	7.52	36.9	9.08	39.5	9.95	42.0	10.81	47.2	12.70	52.4	14.74
	31	26.6	6.47	31.7	7.98	36.9	9.68	39.5	10.57	42.0	11.51	47.2	13.53	52.4	15.71
	33	26.6	6.87	31.7	8.49	36.9	10.30	39.5	11.24	42.0	12.26	47.2	14.42	52.4	16.77
	35	26.6	7.28	31.7	9.00	36.9	10.92	39.5	11.97	42.0	13.05	47.2	15.36	52.4	17.87
	37	26.6	7.68	31.7	9.54	36.9	11.62	38.8	12.72	42.0	13.88	47.2	16.36	52.4	19.03
	39	26.6	8.14	31.7	10.11	36.9	12.32	38.2	13.50	42.0	14.74	47.2	17.39	52.4	20.27
41	25.2	9.17	30.1	11.34	35.1	13.75	37.5	13.88	40.0	15.13	44.9	17.82	49.9	20.73	
43	23.8	9.56	29.2	11.84	33.8	14.49	36.8	14.76	38.0	15.70	44.1	18.27	48.5	21.26	
44	23.4	9.97	28.5	12.33	33.4	15.28	35.9	15.68	38.4	16.31	43.2	18.74	48.2	21.80	
47	22.1	13.27	27.6	16.41	32.3	16.05	34.7	15.92	37.0	17.35	41.8	20.13	46.6	23.41	
50	20.3	13.03	24.7	16.11	28.8	16.92	30.9	17.23	33.0	18.53	37.3	21.51	41.9	24.48	
52	15.9	10.23	21.4	12.74	26.5	14.21	29.2	15.05	29.3	14.56	30.0	14.36	31.7	14.74	

TC—Total capacity of outdoor unit; PI—Power input of outdoor unit															
Combination	Outdoor air temp (°C DB)	Indoor air temp													
		14.0°C WB		16.0°C WB		18.0°C WB		19.0°C WB		20.0°C WB		22.0°C WB		24.0°C WB	
		20.0°C DB		23.0°C DB		26.0°C DB		27.0°C DB		28.0°C DB		30.0°C DB		32.0°C DB	
		TC	PI	TC	PI	TC	PI	TC	PI	TC	PI	TC	PI	TC	PI
		kW	kW	kW	kW	kW	kW	kW	kW	kW	kW	kW	kW	kW	
60%	-5	22.8	3.29	27.2	4.01	31.7	4.81	33.8	5.24	36.1	5.69	40.5	6.64	44.9	7.67
	0	22.8	3.29	27.2	4.02	31.7	4.81	33.8	5.25	36.1	5.70	40.5	6.66	44.9	7.69
	4	22.8	3.30	27.2	4.03	31.7	4.83	33.8	5.27	36.1	5.72	40.5	6.68	44.9	7.71
	7	22.8	3.37	27.2	4.11	31.7	4.92	33.8	5.37	36.1	5.83	40.5	6.80	44.9	7.86
	10	22.8	4.18	27.2	4.91	31.7	5.69	33.8	6.09	36.0	6.50	40.5	7.36	44.9	8.25
	12	22.8	4.26	27.2	4.99	31.7	5.80	33.8	6.20	36.0	6.60	40.5	7.49	44.9	8.38
	14	22.8	4.31	27.2	5.07	31.7	5.88	33.8	6.31	36.0	6.74	40.5	7.63	44.9	8.54
	16	22.8	4.37	27.2	5.15	31.7	5.98	33.8	6.42	36.0	6.85	40.5	7.76	44.9	8.71
	18	22.8	4.45	27.2	5.23	31.7	6.09	33.8	6.52	36.0	6.98	40.5	7.90	44.9	8.87
	20	22.8	4.50	27.2	5.34	31.7	6.20	33.8	6.66	36.0	7.12	40.5	8.06	44.9	9.06
	21	22.8	4.56	27.2	5.36	31.7	6.25	33.8	6.71	36.0	7.17	40.5	8.14	44.9	9.14
	23	22.8	4.61	27.2	5.47	31.7	6.36	33.8	6.85	36.0	7.30	40.5	8.46	44.9	9.73
	25	22.8	4.69	27.2	5.58	31.7	6.60	33.8	7.17	36.0	7.76	40.5	9.03	44.9	10.38
	27	22.8	4.88	27.2	5.90	31.7	7.04	33.8	7.65	36.0	8.27	40.5	9.62	44.9	11.08
	29	22.8	5.15	27.2	6.25	31.7	7.49	33.8	8.14	36.0	8.81	40.5	10.27	44.9	11.83
	31	22.8	5.47	27.2	6.66	31.7	7.95	33.8	8.65	36.0	9.38	40.5	10.92	44.9	12.59
	33	22.8	5.77	27.2	7.04	31.7	8.44	33.8	9.19	36.0	9.97	40.5	11.62	44.9	13.42
	35	22.8	6.12	27.2	7.47	31.7	8.95	33.8	9.76	36.0	10.59	40.5	12.37	44.9	14.29
	37	22.8	6.47	27.2	7.90	31.7	9.49	33.2	10.35	36.0	11.24	40.5	13.15	44.9	15.20
	39	22.8	6.82	27.2	8.36	31.7	10.05	32.8	10.97	36.0	11.94	40.5	13.96	44.9	16.17
41	21.6	7.71	25.8	9.41	30.1	11.28	32.2	11.32	34.2	12.29	38.5	14.35	42.8	16.57	
43	20.4	8.04	24.5	9.80	29.2	11.88	31.6	12.03	33.2	12.75	38.1	14.71	41.9	17.00	
44	20.1	8.38	24.5	10.23	28.7	12.53	30.8	12.78	32.9	13.24	37.1	15.09	41.3	17.43	
47	19.0	11.15	23.7	13.61	27.7	13.15	29.7	12.98	31.7	14.09	35.8	16.21	40.0	18.71	
50	17.4	10.95	21.2	13.36	24.7	13.87	26.5	14.05	28.3	15.04	32.0	17.32	35.9	19.57	
52	13.7	8.34	18.4	10.39	22.7	11.69	25.0	12.27	25.1	11.87	25.7	11.71	27.2	12.02	
50%	-5	19.0	2.72	22.7	3.26	26.4	3.85	28.2	4.17	30.0	4.50	33.7	5.21	37.5	5.96
	0	19.0	2.73	22.7	3.26	26.4	3.86	28.2	4.18	30.0	4.51	33.7	5.22	37.5	5.97
	4	19.0	2.74	22.7	3.27	26.4	3.87	28.2	4.19	30.0	4.53	33.7	5.24	37.5	6.00
	7	19.0	2.79	22.7	3.34	26.4	3.94	28.2	4.27	30.0	4.61	33.7	5.34	37.5	6.11
	10	19.0	3.61	22.7	4.18	26.4	4.77	28.2	5.09	30.0	5.39	33.7	6.06	37.5	6.77
	12	19.0	3.64	22.7	4.23	26.4	4.85	28.2	5.15	30.0	5.50	33.7	6.17	37.5	6.87
	14	19.0	3.69	22.7	4.29	26.4	4.91	28.2	5.26	30.0	5.58	33.7	6.28	37.5	7.01
	16	19.0	3.75	22.7	4.34	26.4	4.99	28.2	5.34	30.0	5.66	33.7	6.39	37.5	7.12
	18	19.0	3.80	22.7	4.42	26.4	5.07	28.2	5.42	30.0	5.77	33.7	6.50	37.5	7.25
	20	19.0	3.85	22.7	4.47	26.4	5.15	28.2	5.53	30.0	5.88	33.7	6.63	37.5	7.39
	21	19.0	3.88	22.7	4.53	26.4	5.20	28.2	5.55	30.0	5.93	33.7	6.68	37.5	7.47
	23	19.0	3.94	22.7	4.58	26.4	5.28	28.2	5.66	30.0	6.04	33.7	6.79	37.5	7.63
	25	19.0	3.99	22.7	4.66	26.4	5.39	28.2	5.77	30.0	6.23	33.7	7.14	37.5	8.14
	27	19.0	4.07	22.7	4.85	26.4	5.69	28.2	6.15	30.0	6.60	33.7	7.60	37.5	8.68
	29	19.0	4.29	22.7	5.12	26.4	6.04	28.2	6.52	29.9	7.04	33.7	8.09	37.5	9.25
	31	19.0	4.53	22.7	5.42	26.4	6.44	28.2	6.93	29.9	7.47	33.7	8.60	37.5	9.84
	33	19.0	4.80	22.7	5.74	26.4	6.79	28.2	7.33	29.9	7.92	33.7	9.14	37.5	10.46
	35	19.0	5.07	22.7	6.06	26.4	7.17	28.2	7.76	29.9	8.38	33.7	9.70	37.5	11.11
	37	19.0	5.34	22.7	6.42	26.4	7.60	27.7	8.22	29.9	8.89	33.7	10.30	37.5	11.81
	39	19.0	5.63	22.7	6.77	26.4	8.03	27.3	8.71	29.9	9.43	33.7	10.92	37.5	12.53
41	18.0	6.38	21.5	7.64	25.1	9.03	26.8	9.00	28.4	9.72	32.1	11.26	35.7	12.88	
43	17.0	6.67	20.4	8.02	24.4	9.52	26.3	9.65	28.0	10.10	31.2	11.55	34.8	13.22	
44	16.7	6.94	20.4	8.31	23.9	10.04	25.7	10.17	27.3	10.48	30.9	11.84	34.5	13.55	
47	15.8	9.24	19.7	11.06	23.1	10.54	24.8	10.32	26.3	11.15	29.8	12.71	33.3	14.55	
50	14.5	9.07	17.7	10.86	20.6	11.11	22.1	11.18	23.5	11.90	26.6	13.58	30.0	15.21	
52	11.4	6.64	15.3	8.26	18.9	9.30	20.8	9.76	20.9	9.44	21.4	9.31	22.7	9.56	

GMV6 HR DC Inverter VRF Units Technical Sales Guide

GMV-VQ615WM/C-X

TC—Total capacity of outdoor unit; PI—Power input of outdoor unit

Combination	Outdoor air temp (°C DB)	Indoor air temp													
		14.0°C WB		16.0°C WB		18.0°C WB		19.0°C WB		20.0°C WB		22.0°C WB		24.0°C WB	
		20.0°C DB		23.0°C DB		26.0°C DB		27.0°C DB		28.0°C DB		30.0°C DB		32.0°C DB	
		TC	PI	TC	PI	TC	PI	TC	PI	TC	PI	TC	PI	TC	PI
		kW	kW	kW	kW	kW	kW	kW	kW	kW	kW	kW	kW	kW	
135%	-5	54.4	11.57	64.8	14.09	75.2	14.26	78.1	14.34	79.5	14.41	81.5	14.58	83.6	14.74
	0	54.4	11.59	64.8	14.12	75.2	14.29	78.1	14.36	79.5	14.44	81.5	14.61	83.6	14.76
	4	54.4	11.64	64.8	14.17	75.2	14.34	78.1	14.42	79.5	14.49	81.5	14.67	83.6	14.82
	7	54.4	11.85	64.8	14.43	75.2	14.61	78.1	14.68	79.5	14.76	81.5	14.94	83.6	15.09
	10	54.4	12.06	64.8	14.74	75.2	17.53	78.1	17.92	79.0	17.56	81.0	16.82	82.9	16.05
	12	54.4	12.27	64.8	15.02	75.2	17.88	77.0	17.81	78.1	17.46	79.8	16.68	81.8	16.44
	14	54.4	12.52	64.8	15.31	75.0	18.09	76.1	17.74	77.0	17.35	79.0	17.21	81.0	17.39
	16	54.4	12.73	64.8	15.62	74.1	18.02	75.0	17.88	75.9	17.95	77.9	18.13	79.8	18.30
	18	54.4	12.98	64.8	15.94	73.0	18.69	73.9	18.80	75.0	18.90	77.0	19.08	79.0	19.26
	20	54.4	13.26	64.8	16.96	71.9	19.61	73.0	19.72	73.9	19.82	75.9	20.00	77.9	20.21
	21	54.4	13.61	64.8	17.56	71.4	20.07	72.5	20.17	73.4	20.28	75.4	20.49	77.4	20.67
	23	54.4	14.60	64.8	18.83	70.6	20.99	71.4	21.09	72.3	21.20	74.3	21.41	76.3	21.62
	25	54.4	15.59	64.8	20.17	69.5	21.90	70.6	22.01	71.4	22.15	73.4	22.36	75.4	22.57
	27	54.4	16.65	64.8	21.58	68.6	19.29	69.5	22.96	70.3	23.07	72.3	23.31	74.3	23.56
	29	54.4	17.78	64.8	23.07	67.5	23.74	68.3	23.88	69.5	24.02	71.4	24.27	73.4	24.51
	31	54.4	18.98	64.6	24.41	66.4	24.69	67.5	24.83	68.3	24.94	70.3	25.22	72.3	25.50
	33	54.4	20.21	63.5	25.32	65.5	25.57	66.4	25.75	67.5	25.89	69.5	26.17	71.2	26.49
	35	54.4	21.55	62.4	26.24	64.4	26.56	65.5	26.70	66.4	26.84	68.3	27.16	70.3	27.44
	37	54.4	22.93	61.5	27.19	63.5	27.51	64.4	27.65	65.5	27.83	67.2	28.15	69.2	28.46
	39	54.4	24.41	60.4	28.11	62.4	28.43	63.5	28.60	64.4	28.78	66.4	29.10	68.3	29.45
41	51.4	27.15	59.3	33.06	61.2	33.46	62.2	30.97	63.1	31.13	65.1	31.50	67.0	31.83	
43	48.6	28.31	58.1	34.46	60.0	35.27	61.0	32.92	61.9	32.32	63.8	32.30	65.7	32.63	
44	47.9	29.52	56.1	35.95	58.2	37.18	59.6	34.98	60.6	33.55	62.6	33.13	64.7	33.48	
47	45.2	39.29	54.3	47.84	56.3	39.04	57.5	35.51	58.4	35.70	60.5	35.58	62.6	35.95	
50	41.4	38.57	48.7	46.97	50.3	41.16	51.3	38.45	52.1	38.11	54.0	38.02	56.3	37.59	
52	26.4	22.83	35.5	28.42	44.0	31.98	48.4	33.58	48.6	32.47	49.8	32.03	52.6	32.89	
120%	-5	50.2	10.30	59.7	13.33	69.5	14.17	74.3	14.24	78.2	14.32	80.0	14.47	81.7	14.62
	0	50.2	10.32	59.7	13.36	69.5	14.19	74.3	14.27	78.2	14.35	80.0	14.50	81.7	14.65
	4	50.2	10.36	59.7	13.41	69.5	14.25	74.3	14.32	78.2	14.40	80.0	14.55	81.7	14.70
	7	50.2	10.55	59.7	13.66	69.5	14.51	74.3	14.59	78.2	14.67	80.0	14.82	81.7	14.98
	10	50.2	11.00	59.7	13.44	69.5	15.98	74.3	17.28	77.9	18.02	79.6	17.32	81.4	16.65
	12	50.2	11.22	59.7	13.68	69.5	16.29	74.3	17.60	76.7	17.92	78.5	17.25	80.3	16.54
	14	50.2	11.43	59.7	13.97	69.5	16.61	74.3	17.95	75.6	17.81	77.6	17.14	79.4	17.25
	16	50.2	11.64	59.7	14.25	69.5	16.93	73.9	18.09	74.8	17.85	76.5	18.02	78.3	18.16
	18	50.2	11.85	59.7	14.53	69.5	17.53	72.8	18.69	73.7	18.76	75.4	18.94	77.4	19.12
	20	50.2	12.10	59.7	15.10	69.5	18.83	71.9	19.61	72.8	19.68	74.5	19.86	76.3	20.03
	21	50.2	12.20	59.7	15.62	69.5	19.50	71.2	20.07	72.1	20.14	74.1	20.32	75.9	20.53
	23	50.2	13.05	59.7	16.75	69.5	20.88	70.3	20.95	71.2	21.06	73.0	21.27	74.8	21.44
	25	50.2	13.93	59.7	17.92	68.3	21.80	69.2	21.87	70.1	21.97	72.1	22.18	73.9	22.40
	27	50.2	14.88	59.7	19.15	67.5	22.68	68.3	22.82	69.2	22.93	71.0	23.14	72.8	23.35
	29	50.2	15.87	59.7	20.46	66.4	23.60	67.2	23.74	68.1	23.84	69.9	24.09	71.9	24.30
	31	50.2	16.93	59.7	21.83	65.5	24.55	66.4	24.65	67.2	24.79	69.0	25.04	70.8	25.29
	33	50.2	18.02	59.7	23.31	64.4	25.46	65.2	25.61	66.1	25.71	67.9	25.99	69.7	26.24
	35	50.2	19.19	59.7	24.83	63.3	26.38	64.1	26.52	65.2	26.66	67.0	26.95	68.8	27.23
	37	50.2	20.42	59.7	26.45	62.4	27.33	63.3	27.47	64.1	27.62	65.9	27.90	67.7	28.22
	39	50.2	21.73	59.5	27.93	61.3	28.25	62.2	28.43	63.0	28.57	65.0	28.89	66.8	29.17
41	47.4	24.18	56.7	31.29	60.1	33.24	61.0	30.77	62.1	30.93	63.8	31.26	65.6	31.58	
43	44.8	25.20	54.1	32.61	59.0	35.03	59.8	32.69	61.1	32.11	62.6	32.05	64.3	32.40	
44	44.2	26.29	53.7	34.02	57.2	36.93	58.4	34.74	59.6	33.33	61.4	32.87	63.3	33.22	
47	41.7	34.98	52.0	45.26	55.4	38.78	56.3	35.28	57.4	35.46	59.3	35.30	61.2	35.67	
50	38.2	34.34	46.6	44.45	49.4	40.89	50.2	38.19	51.2	37.86	52.9	37.72	55.0	37.30	
52	25.9	22.68	34.8	28.23	43.1	31.77	47.4	33.36	47.6	32.26	48.8	31.82	51.5	32.68	

		TC—Total capacity of outdoor unit; PI—Power input of outdoor unit													
Combination	Outdoor air temp (°C DB)	Indoor air temp													
		14.0°C WB		16.0°C WB		18.0°C WB		19.0°C WB		20.0°C WB		22.0°C WB		24.0°C WB	
		20.0°C DB		23.0°C DB		26.0°C DB		27.0°C DB		28.0°C DB		30.0°C DB		32.0°C DB	
		TC	PI	TC	PI	TC	PI	TC	PI	TC	PI	TC	PI	TC	PI
		kW	kW	kW	kW	kW	kW	kW	kW	kW	kW	kW	kW	kW	
110%	-5	46.0	9.11	54.9	11.72	63.7	14.07	68.1	14.15	72.5	14.22	78.2	14.36	79.8	14.49
	0	46.0	9.13	54.9	11.75	63.7	14.10	68.1	14.17	72.5	14.25	78.2	14.38	79.8	14.52
	4	46.0	9.16	54.9	11.79	63.7	14.15	68.1	14.23	72.5	14.30	78.2	14.44	79.8	14.57
	7	46.0	9.33	54.9	12.01	63.7	14.41	68.1	14.49	72.5	14.57	78.2	14.70	79.8	14.84
	10	46.0	9.98	54.9	12.17	63.7	14.46	68.1	15.62	72.5	16.82	78.1	17.85	79.8	17.25
	12	46.0	10.19	54.9	12.41	63.7	14.74	68.1	15.94	72.5	17.14	77.2	17.78	78.7	17.14
	14	46.0	10.37	54.9	12.63	63.7	15.02	68.1	16.22	72.5	17.46	76.1	17.78	77.9	17.11
	16	46.0	10.55	54.9	12.87	63.7	15.31	68.1	16.54	72.5	17.81	75.2	17.88	76.7	18.06
	18	46.0	10.76	54.9	13.12	63.7	15.62	68.1	17.00	72.5	18.66	74.1	18.80	75.9	18.98
	20	46.0	10.97	54.9	13.40	63.7	16.54	68.1	18.27	71.4	19.57	73.2	19.72	74.8	19.89
	21	46.0	11.07	54.9	13.79	63.7	17.14	68.1	18.94	71.0	20.03	72.5	20.17	74.3	20.35
	23	46.0	11.60	54.9	14.78	63.7	18.38	68.1	20.32	69.9	20.91	71.7	21.13	73.2	21.30
	25	46.0	12.34	54.9	15.80	63.7	19.65	68.1	21.76	69.0	21.83	70.6	22.04	72.3	22.22
	27	46.0	13.19	54.9	16.89	63.7	21.02	67.0	22.68	67.9	22.75	69.7	22.96	71.2	23.17
	29	46.0	14.07	54.9	18.02	63.7	22.47	66.1	23.60	67.0	23.70	68.6	23.91	70.3	24.12
	31	46.0	14.99	54.9	19.22	63.7	23.98	65.0	24.51	65.9	24.62	67.7	24.83	69.2	25.08
	33	46.0	15.94	54.9	20.49	63.3	25.29	64.1	25.43	65.0	25.54	66.6	25.78	68.3	26.03
	35	46.0	16.96	54.9	21.83	62.4	26.21	63.0	26.35	63.9	26.49	65.5	26.73	67.2	26.98
	37	46.0	18.06	54.9	23.24	61.3	27.16	62.2	27.26	62.8	27.40	64.6	27.69	66.1	27.93
	39	46.0	19.19	54.9	24.76	60.2	28.07	61.0	28.22	61.9	28.36	63.5	28.64	65.2	28.92
41	43.5	21.38	52.1	27.51	59.3	33.02	59.9	30.56	60.8	30.73	62.3	31.01	64.1	31.30	
43	41.1	22.29	49.5	28.68	58.4	34.80	58.8	32.49	59.7	31.90	61.2	31.80	62.9	32.09	
44	40.5	23.24	49.4	29.91	56.4	36.69	57.4	34.51	58.4	33.11	60.0	32.62	61.9	32.92	
47	38.2	30.93	47.7	39.80	54.6	38.52	55.3	35.04	56.3	35.23	57.9	35.02	59.8	35.35	
50	35.0	30.37	42.8	39.08	48.7	40.62	49.4	37.94	50.2	37.61	51.7	37.43	53.8	36.96	
52	25.4	22.53	34.2	28.05	42.3	31.56	46.6	33.14	46.8	32.04	48.0	31.61	50.7	32.46	
100%	-5	41.8	7.97	49.8	10.20	57.9	12.72	61.5	14.05	65.9	14.12	74.1	14.25	78.3	14.38
	0	41.8	7.98	49.8	10.22	57.9	12.74	61.5	14.08	65.9	14.15	74.1	14.28	78.3	14.41
	4	41.8	8.01	49.8	10.26	57.9	12.79	61.5	14.13	65.9	14.20	74.1	14.33	78.3	14.46
	7	41.8	8.16	49.8	10.45	57.9	13.03	61.5	14.39	65.9	14.47	74.1	14.60	78.3	14.73
	10	41.8	9.03	49.8	10.97	57.9	12.97	61.5	14.01	65.9	15.13	74.1	17.12	78.3	17.79
	12	41.8	9.15	49.8	11.11	57.9	13.15	61.5	14.19	65.9	15.42	74.1	17.42	77.2	17.65
	14	41.8	9.31	49.8	11.31	57.9	13.37	61.5	14.45	65.9	15.70	74.1	17.72	76.3	17.51
	16	41.8	9.52	49.8	11.56	57.9	13.67	61.5	14.78	65.9	16.06	73.8	18.12	75.2	17.91
	18	41.8	9.73	49.8	11.82	57.9	13.94	61.5	15.07	65.9	16.37	72.8	18.47	74.3	18.75
	20	41.8	9.88	49.8	12.00	57.9	14.40	61.5	15.86	65.9	17.41	71.7	19.44	73.2	19.74
	21	41.8	9.98	49.8	12.12	57.9	14.89	61.5	16.40	65.9	18.01	71.2	20.10	72.8	20.28
	23	41.8	10.23	49.8	12.95	57.9	16.01	61.5	17.63	65.9	19.36	70.4	21.27	71.7	21.46
	25	41.8	10.89	49.8	13.78	57.9	17.03	61.5	18.76	65.9	20.71	69.2	22.04	70.8	22.24
	27	41.8	11.63	49.8	14.72	57.9	18.28	61.5	20.13	65.9	22.22	68.1	22.82	69.7	23.03
	29	41.8	12.32	49.8	15.73	57.9	19.55	61.5	21.53	65.7	23.54	67.2	23.92	68.7	24.14
	31	41.8	13.11	49.8	16.75	57.9	20.84	61.5	23.20	64.9	24.49	65.6	24.89	67.7	25.12
	33	41.8	13.94	49.8	17.84	57.9	22.22	61.5	24.55	63.7	25.38	65.3	25.61	66.8	25.84
	35	41.8	14.83	49.8	18.99	57.9	23.68	61.5	26.17	62.6	26.30	64.1	26.54	65.6	26.78
	37	41.8	15.80	49.8	20.23	57.9	25.22	60.8	27.11	61.8	27.25	63.2	27.44	64.7	27.69
	39	41.8	16.83	49.8	21.54	57.9	26.86	60.0	28.01	60.3	28.15	62.4	28.35	63.2	28.60
41	39.5	18.69	47.3	23.93	55.1	29.84	58.9	30.36	59.5	30.51	61.0	30.78	62.6	31.06	
43	37.3	19.49	44.9	24.97	53.7	31.45	57.8	32.27	58.7	31.67	59.7	31.57	62.0	31.86	
44	36.8	20.32	44.8	26.02	52.4	33.16	56.4	34.28	57.1	32.88	58.7	32.38	60.4	32.67	
47	34.7	27.04	43.3	34.63	50.7	34.82	54.4	34.81	55.1	34.98	56.7	34.76	58.4	35.08	
50	31.8	26.55	38.8	34.00	45.3	36.71	48.5	37.68	49.1	37.35	50.6	37.15	52.5	36.68	
52	25.0	20.51	33.6	25.53	41.6	28.73	45.8	30.16	46.0	29.17	47.1	28.78	49.8	29.55	

GMV6 HR DC Inverter VRF Units Technical Sales Guide

TC—Total capacity of outdoor unit; PI—Power input of outdoor unit

Combination	Outdoor air temp (°C DB)	Indoor air temp													
		14.0°C WB		16.0°C WB		18.0°C WB		19.0°C WB		20.0°C WB		22.0°C WB		24.0°C WB	
		20.0°C DB		23.0°C DB		26.0°C DB		27.0°C DB		28.0°C DB		30.0°C DB		32.0°C DB	
		TC	PI	TC	PI	TC	PI	TC	PI	TC	PI	TC	PI	TC	PI
		kW	kW	kW	kW	kW	kW	kW	kW	kW	kW	kW	kW	kW	
90%	-5	37.6	6.95	44.8	8.80	52.2	10.86	55.7	12.00	59.3	13.20	66.6	14.13	73.9	14.25
	0	37.6	6.96	44.8	8.81	52.2	10.88	55.7	12.02	59.3	13.23	66.6	14.15	73.9	14.28
	4	37.6	6.99	44.8	8.85	52.2	10.92	55.7	12.07	59.3	13.28	66.6	14.20	73.9	14.33
	7	37.6	7.12	44.8	9.01	52.2	11.12	55.7	12.29	59.3	13.52	66.6	14.47	73.9	14.60
	10	37.6	7.88	44.8	9.46	52.2	11.08	55.7	12.48	59.3	13.29	66.7	15.23	73.9	17.25
	12	37.6	7.98	44.8	9.59	52.2	11.23	55.7	12.65	59.3	13.55	66.7	15.49	73.9	17.48
	14	37.6	8.12	44.8	9.75	52.2	11.42	55.7	12.84	59.3	13.78	66.7	15.76	73.9	17.76
	16	37.6	8.30	44.8	9.97	52.2	11.68	55.7	13.13	59.3	14.09	66.7	16.11	73.6	18.11
	18	37.6	8.49	44.8	10.20	52.2	11.90	55.7	13.38	59.3	14.36	66.7	16.49	73.0	18.76
	20	37.6	8.62	44.8	10.35	52.2	12.30	55.7	13.66	59.3	14.96	66.7	17.71	71.7	19.55
	21	37.6	8.71	44.8	10.46	52.2	12.72	55.7	14.11	59.3	15.47	66.7	18.32	71.2	19.98
	23	37.6	8.93	44.8	11.17	52.2	13.67	55.7	15.17	59.3	16.57	66.7	19.68	70.1	21.01
	25	37.6	9.50	44.8	11.88	52.2	14.55	55.7	16.19	59.3	17.72	66.7	21.04	69.2	21.87
	27	37.6	10.15	44.8	12.70	52.2	15.61	55.7	17.28	59.3	18.97	66.7	22.46	68.1	22.83
	29	37.6	10.75	44.8	13.56	52.2	16.69	55.7	18.46	59.3	20.25	65.9	23.54	67.2	23.75
	31	37.6	11.44	44.8	14.45	52.2	17.80	55.7	19.71	59.3	21.61	64.8	24.39	66.1	24.72
	33	37.6	12.17	44.8	15.38	52.2	18.97	55.7	20.96	59.3	22.99	63.9	25.38	65.2	25.61
	35	37.6	12.94	44.8	16.38	52.2	20.23	55.7	22.35	59.3	24.58	62.8	26.30	64.1	26.54
	37	37.6	13.78	44.8	17.45	52.2	21.54	54.7	23.15	59.3	26.30	61.7	27.25	63.3	27.18
	39	37.6	14.68	44.8	18.58	52.2	22.94	54.0	23.92	59.3	27.88	60.8	28.26	62.2	28.18
41	35.6	16.31	42.5	20.64	49.6	25.48	53.0	25.93	56.4	28.52	59.8	30.51	61.1	30.79	
43	33.6	17.00	40.4	21.51	48.2	26.87	52.0	27.55	55.3	29.61	58.8	31.29	60.1	31.63	
44	33.1	17.73	40.3	22.44	47.2	28.32	50.7	29.28	54.2	30.73	57.5	32.09	59.0	32.38	
47	31.2	23.59	39.0	29.87	45.6	29.73	48.9	29.72	52.2	32.70	55.6	34.46	57.1	34.77	
50	28.6	23.17	34.9	29.33	40.7	31.35	43.6	32.18	46.6	34.91	49.6	36.83	51.3	36.36	
52	22.5	19.12	30.3	23.80	37.4	26.79	41.2	28.12	41.4	27.20	42.9	26.83	44.8	27.55	
80%	-5	33.4	6.00	39.8	7.41	46.4	9.20	49.5	10.13	52.6	11.07	59.3	13.15	65.7	14.08
	0	33.4	6.02	39.8	7.42	46.4	9.22	49.5	10.15	52.6	11.10	59.3	13.17	65.7	14.11
	4	33.4	6.04	39.8	7.45	46.4	9.26	49.5	10.19	52.6	11.14	59.3	13.22	65.7	14.16
	7	33.4	6.15	39.8	7.58	46.4	9.43	49.5	10.38	52.6	11.34	59.3	13.46	65.7	14.43
	10	33.4	7.16	39.8	8.57	46.4	10.09	49.5	10.86	52.7	11.63	59.3	13.29	65.7	15.43
	12	33.4	7.27	39.8	8.71	46.4	10.26	49.5	11.07	52.7	11.86	59.3	13.52	65.7	15.31
	14	33.4	7.41	39.8	8.89	46.4	10.44	49.5	11.25	52.7	12.07	59.3	13.75	65.7	15.65
	16	33.4	7.51	39.8	9.03	46.4	10.65	49.5	11.46	52.7	12.26	59.3	14.06	65.7	16.22
	18	33.4	7.65	39.8	9.21	46.4	10.89	49.5	11.71	52.7	12.50	59.3	14.38	65.7	17.35
	20	33.4	7.79	39.8	9.38	46.4	11.07	49.5	11.92	52.7	12.78	59.3	14.90	65.7	17.98
	21	33.4	7.87	39.8	9.45	46.4	11.18	49.5	12.06	52.7	13.06	59.3	15.44	65.7	19.25
	23	33.4	8.01	39.8	9.66	46.4	11.71	49.5	12.84	52.7	13.97	59.3	16.51	65.7	20.59
	25	33.4	8.25	39.8	10.26	46.4	12.52	49.5	13.72	52.7	14.91	59.3	17.68	65.7	21.97
	27	33.4	8.78	39.8	10.93	46.4	13.33	49.5	14.64	52.7	16.00	59.3	18.87	65.7	22.74
	29	33.4	9.35	39.8	11.64	46.4	14.21	49.5	15.59	52.6	17.06	59.3	20.14	65.7	23.57
	31	33.4	9.91	39.8	12.38	46.4	15.13	49.5	16.61	52.6	18.18	59.3	21.49	64.6	24.42
	33	33.4	10.55	39.8	13.79	46.4	16.12	49.5	17.70	52.6	19.37	59.3	22.94	63.7	25.31
	35	33.4	11.18	39.8	13.79	46.4	17.14	49.5	18.87	52.6	20.62	59.3	24.48	62.6	26.23
	37	33.4	11.85	39.8	14.85	46.4	18.23	48.7	20.10	52.6	21.96	59.3	26.07	61.7	27.20
	39	33.4	12.56	39.8	15.77	46.4	19.40	48.0	21.40	52.6	23.39	59.3	27.77	60.6	28.20
41	31.6	14.09	37.8	17.38	44.1	21.60	47.1	21.89	50.0	23.92	56.4	28.40	59.7	30.42	
43	29.9	14.68	36.7	18.13	42.9	22.75	46.2	23.27	48.9	24.83	55.3	29.12	58.7	31.20	
44	29.4	15.32	35.8	18.89	42.0	24.00	45.1	24.72	48.0	25.78	54.3	29.87	57.6	32.00	
47	27.8	20.38	34.6	25.14	40.6	25.20	43.5	25.10	46.2	27.43	52.4	32.07	55.7	34.36	
50	25.4	20.01	31.1	24.68	36.2	26.57	38.8	27.17	41.3	29.29	46.8	34.27	50.1	35.93	
52	20.0	16.14	26.9	20.09	33.3	22.60	36.6	23.73	36.8	22.95	37.7	22.64	39.8	23.25	

TC—Total capacity of outdoor unit; PI—Power input of outdoor unit															
Combination	Outdoor air temp (°C DB)	Indoor air temp													
		14.0°C WB		16.0°C WB		18.0°C WB		19.0°C WB		20.0°C WB		22.0°C WB		24.0°C WB	
		20.0°C DB		23.0°C DB		26.0°C DB		27.0°C DB		28.0°C DB		30.0°C DB		32.0°C DB	
		TC	PI	TC	PI	TC	PI	TC	PI	TC	PI	TC	PI	TC	PI
		kW	kW	kW	kW	kW	kW	kW	kW	kW	kW	kW	kW	kW	
70%	-5	29.3	5.11	34.8	6.33	40.6	7.67	43.4	8.41	46.2	9.17	51.8	10.80	57.5	12.56
	0	29.3	5.12	34.8	6.34	40.6	7.68	43.4	8.42	46.2	9.18	51.8	10.82	57.5	12.58
	4	29.3	5.14	34.8	6.36	40.6	7.71	43.4	8.46	46.2	9.22	51.8	10.86	57.5	12.63
	7	29.3	5.24	34.8	6.48	40.6	7.86	43.4	8.61	46.2	9.39	51.8	11.06	57.5	12.86
	10	29.3	6.31	34.8	7.48	40.6	8.71	43.4	9.38	46.1	10.05	51.8	11.43	57.5	12.84
	12	29.3	6.38	34.8	7.58	40.6	8.89	43.4	9.56	46.1	10.23	51.8	11.64	57.5	13.09
	14	29.3	6.49	34.8	7.72	40.6	9.03	43.4	9.70	46.1	10.40	51.8	11.85	57.5	13.33
	16	29.3	6.60	34.8	7.87	40.6	9.21	43.4	9.91	46.1	10.62	51.8	12.06	57.5	13.58
	18	29.3	6.70	34.8	8.01	40.6	9.38	43.4	10.09	46.1	10.79	51.8	12.31	57.5	13.86
	20	29.3	6.81	34.8	8.15	40.6	9.56	43.4	10.26	46.1	11.00	51.8	12.56	57.5	14.25
	21	29.3	6.88	34.8	8.22	40.6	9.63	43.4	10.37	46.1	11.11	51.8	12.70	57.5	14.74
	23	29.3	6.98	34.8	8.36	40.6	9.84	43.4	10.72	46.1	11.67	51.8	13.65	57.5	15.80
	25	29.3	7.12	34.8	8.71	40.6	10.48	43.4	11.46	46.1	12.45	51.8	14.60	57.5	16.89
	27	29.3	7.55	34.8	9.28	40.6	11.18	43.4	12.20	46.1	13.30	51.8	15.59	57.5	18.06
	29	29.3	8.01	34.8	9.84	40.6	11.89	43.4	13.01	46.1	14.14	51.8	16.61	57.5	19.29
	31	29.3	8.46	34.8	10.44	40.6	12.66	43.4	13.83	46.1	15.06	51.8	17.71	57.5	20.56
	33	29.3	8.99	34.8	11.11	40.6	13.47	43.4	14.71	46.1	16.05	51.8	18.87	57.5	21.94
	35	29.3	9.52	34.8	11.78	40.6	14.28	43.4	15.66	46.1	17.07	51.8	20.10	57.5	23.38
	37	29.3	10.05	34.8	12.49	40.6	15.20	42.6	16.65	46.1	18.16	51.8	21.41	57.5	24.90
	39	29.3	10.65	34.8	13.23	40.6	16.12	42.0	17.67	46.1	19.29	51.8	22.75	57.5	26.52
41	27.7	12.00	33.1	14.84	38.5	18.00	41.2	18.17	43.9	19.80	49.4	23.32	54.8	27.13	
43	26.1	12.51	32.1	15.49	37.2	18.97	40.4	19.31	41.7	20.55	48.4	23.91	53.3	27.82	
44	25.8	13.05	31.4	16.14	36.7	20.00	39.4	20.51	42.1	21.34	47.5	24.53	52.9	28.53	
47	24.3	17.36	30.3	21.47	35.5	21.00	38.1	20.83	40.6	22.70	45.9	26.34	51.2	30.63	
50	22.2	17.05	27.2	21.09	31.7	22.14	33.9	22.55	36.2	24.24	41.0	28.15	46.0	32.04	
52	17.5	13.39	23.5	16.67	29.1	18.59	32.0	19.70	32.2	19.05	33.0	18.79	34.8	19.29	
60%	-5	25.1	4.30	29.9	5.25	34.8	6.29	37.2	6.86	39.6	7.44	44.5	8.69	49.3	10.04
	0	25.1	4.31	29.9	5.26	34.8	6.30	37.2	6.87	39.6	7.46	44.5	8.71	49.3	10.06
	4	25.1	4.32	29.9	5.28	34.8	6.32	37.2	6.89	39.6	7.48	44.5	8.74	49.3	10.09
	7	25.1	4.40	29.9	5.37	34.8	6.44	37.2	7.02	39.6	7.62	44.5	8.90	49.3	10.28
	10	25.1	5.47	29.9	6.42	34.8	7.44	37.2	7.97	39.5	8.50	44.4	9.63	49.3	10.79
	12	25.1	5.57	29.9	6.52	34.8	7.58	37.2	8.11	39.5	8.64	44.4	9.80	49.3	10.97
	14	25.1	5.64	29.9	6.63	34.8	7.69	37.2	8.25	39.5	8.82	44.4	9.98	49.3	11.18
	16	25.1	5.71	29.9	6.74	34.8	7.83	37.2	8.39	39.5	8.96	44.4	10.16	49.3	11.39
	18	25.1	5.82	29.9	6.84	34.8	7.97	37.2	8.54	39.5	9.13	44.4	10.33	49.3	11.60
	20	25.1	5.89	29.9	6.98	34.8	8.11	37.2	8.71	39.5	9.31	44.4	10.55	49.3	11.85
	21	25.1	5.96	29.9	7.02	34.8	8.18	37.2	8.78	39.5	9.38	44.4	10.65	49.3	11.96
	23	25.1	6.03	29.9	7.16	34.8	8.32	37.2	8.96	39.5	9.56	44.4	11.07	49.3	12.73
	25	25.1	6.14	29.9	7.30	34.8	8.64	37.2	9.38	39.5	10.16	44.4	11.82	49.3	13.58
	27	25.1	6.38	29.9	7.72	34.8	9.21	37.2	10.02	39.5	10.83	44.4	12.59	49.3	14.50
	29	25.1	6.74	29.9	8.18	34.8	9.80	37.2	10.65	39.5	11.53	44.4	13.44	49.3	15.48
	31	25.1	7.16	29.9	8.71	34.8	10.40	37.2	11.32	39.5	12.27	44.4	14.28	49.3	16.47
	33	25.1	7.55	29.9	9.21	34.8	11.04	37.2	12.03	39.5	13.05	44.4	15.20	49.3	17.56
	35	25.1	8.01	29.9	9.77	34.8	11.71	37.2	12.77	39.5	13.86	44.4	16.19	49.3	18.69
	37	25.1	8.46	29.9	10.33	34.8	12.41	36.5	13.54	39.5	14.71	44.4	17.21	49.3	19.89
	39	25.1	8.92	29.9	10.93	34.8	13.16	36.0	14.35	39.5	15.62	44.4	18.27	49.3	21.16
41	23.7	10.09	28.4	12.31	33.0	14.75	35.3	14.81	37.6	16.08	42.3	18.78	47.0	21.68	
43	22.4	10.52	26.9	12.83	32.1	15.55	34.7	15.74	36.5	16.69	41.8	19.25	46.0	22.25	
44	22.1	10.97	26.9	13.38	31.5	16.39	33.8	16.73	36.1	17.33	40.7	19.75	45.4	22.81	
47	20.8	14.60	26.0	17.81	30.4	17.21	32.6	16.98	34.8	18.44	39.3	21.21	43.9	24.49	
50	19.1	14.33	23.3	17.49	27.2	18.15	29.1	18.39	31.0	19.68	35.1	22.66	39.5	25.61	
52	15.0	10.92	20.2	13.59	24.9	15.29	27.5	16.06	27.6	15.53	28.3	15.32	29.9	15.73	

GMV6 HR DC Inverter VRF Units Technical Sales Guide

TC—Total capacity of outdoor unit; PI—Power input of outdoor unit															
Combination	Outdoor air temp (°C DB)	Indoor air temp													
		14.0°C WB		16.0°C WB		18.0°C WB		19.0°C WB		20.0°C WB		22.0°C WB		24.0°C WB	
		20.0°C DB		23.0°C DB		26.0°C DB		27.0°C DB		28.0°C DB		30.0°C DB		32.0°C DB	
		TC	PI	TC	PI	TC	PI	TC	PI	TC	PI	TC	PI	TC	PI
		kW	kW	kW	kW	kW	kW	kW	kW	kW	kW	kW	kW	kW	
50%	-5	20.9	3.56	24.9	4.26	29.0	5.04	31.0	5.45	33.0	5.89	37.0	6.82	41.1	7.80
	0	20.9	3.57	24.9	4.27	29.0	5.05	31.0	5.46	33.0	5.90	37.0	6.83	41.1	7.82
	4	20.9	3.58	24.9	4.29	29.0	5.07	31.0	5.49	33.0	5.92	37.0	6.86	41.1	7.85
	7	20.9	3.65	24.9	4.36	29.0	5.16	31.0	5.59	33.0	6.03	37.0	6.98	41.1	7.99
	10	20.9	4.73	24.9	5.47	29.0	6.24	31.0	6.67	33.0	7.05	37.0	7.94	41.1	8.85
	12	20.9	4.76	24.9	5.54	29.0	6.35	31.0	6.74	33.0	7.19	37.0	8.08	41.1	8.99
	14	20.9	4.83	24.9	5.61	29.0	6.42	31.0	6.88	33.0	7.30	37.0	8.22	41.1	9.17
	16	20.9	4.90	24.9	5.68	29.0	6.52	31.0	6.98	33.0	7.41	37.0	8.36	41.1	9.31
	18	20.9	4.97	24.9	5.78	29.0	6.63	31.0	7.09	33.0	7.55	37.0	8.50	41.1	9.49
	20	20.9	5.04	24.9	5.85	29.0	6.74	31.0	7.23	33.0	7.69	37.0	8.68	41.1	9.66
	21	20.9	5.08	24.9	5.93	29.0	6.81	31.0	7.27	33.0	7.76	37.0	8.75	41.1	9.77
	23	20.9	5.15	24.9	6.00	29.0	6.91	31.0	7.41	33.0	7.90	37.0	8.89	41.1	9.98
	25	20.9	5.22	24.9	6.10	29.0	7.05	31.0	7.55	33.0	8.15	37.0	9.35	41.1	10.65
	27	20.9	5.33	24.9	6.35	29.0	7.44	31.0	8.04	33.0	8.64	37.0	9.95	41.1	11.36
	29	20.9	5.61	24.9	6.70	29.0	7.90	31.0	8.54	32.8	9.21	37.0	10.58	41.1	12.10
	31	20.9	5.93	24.9	7.09	29.0	8.43	31.0	9.06	32.8	9.77	37.0	11.25	41.1	12.87
	33	20.9	6.28	24.9	7.51	29.0	8.89	31.0	9.59	32.8	10.37	37.0	11.96	41.1	13.68
	35	20.9	6.63	24.9	7.94	29.0	9.38	31.0	10.16	32.8	10.97	37.0	12.70	41.1	14.53
	37	20.9	6.98	24.9	8.39	29.0	9.95	30.4	10.76	32.8	11.64	37.0	13.47	41.1	15.45
	39	20.9	7.37	24.9	8.85	29.0	10.51	30.0	11.39	32.8	12.34	37.0	14.28	41.1	16.40
41	19.8	8.35	23.6	10.00	27.5	11.82	29.4	11.78	31.2	12.72	35.3	14.73	39.2	16.86	
43	18.7	8.72	22.5	10.49	26.8	12.45	28.9	12.63	30.7	13.22	34.3	15.11	38.3	17.29	
44	18.4	9.08	22.4	10.87	26.2	13.13	28.2	13.31	30.0	13.71	33.9	15.49	37.8	17.73	
47	17.3	12.09	21.6	14.47	25.4	13.79	27.2	13.51	28.9	14.59	32.8	16.63	36.6	19.04	
50	15.9	11.87	19.4	14.20	22.6	14.54	24.2	14.63	25.8	15.58	29.3	17.78	32.9	19.91	
52	12.5	8.69	16.8	10.81	20.8	12.17	22.9	12.78	23.0	12.35	23.6	12.19	24.9	12.51	

► Rectification of heating capacity
 GMV-VQ224WM/C-X

TC—Total capacity of outdoor unit; PI—Power input of outdoor unit														
combination	outdoor air temp		indoor air temperature °C DB											
			16		18		20		21		22		24	
	°C DB	°C WB	TC	PI	TC	PI	TC	PI	TC	PI	TC	PI	TC	PI
135%	-19.8	-20.0	20.6	4.83	20.5	5.18	20.5	6.00	20.4	5.63	20.4	5.83	20.4	6.19
	-18.8	-19.0	20.8	4.91	20.7	5.25	20.7	5.52	20.7	5.71	20.6	5.87	20.6	6.23
	-16.7	-17.0	21.1	5.03	21.1	5.35	21.0	5.60	21.0	5.75	21.0	5.93	20.9	6.28
	-13.7	-15.0	21.5	5.13	21.4	5.44	21.4	5.67	21.4	5.83	21.3	6.01	21.3	6.30
	-11.8	-13.0	21.8	5.23	21.7	5.50	21.7	5.70	21.7	5.89	21.6	6.02	21.7	6.34
	-9.8	-11.0	22.2	5.30	22.1	5.57	22.0	5.76	22.1	5.90	22.1	6.05	22.0	6.33
	-9.5	-10.0	22.3	5.32	22.3	5.57	22.3	5.77	22.2	5.90	22.2	6.06	22.2	6.30
	-8.5	-9.1	22.5	5.36	22.5	5.60	22.5	5.77	22.4	5.91	22.4	6.03	22.4	6.31
	-7.0	-7.6	22.8	5.38	22.7	5.60	22.7	5.77	22.7	5.88	22.7	6.03	22.6	6.28
	-5.0	-5.6	24.6	5.73	24.5	5.84	24.5	6.12	24.5	6.23	24.4	6.36	24.4	6.58
	-3.0	-3.7	24.9	5.73	24.8	5.93	24.8	6.06	24.8	6.19	24.8	6.29	24.7	6.51
	0.0	-0.7	25.4	5.68	25.4	5.85	25.3	5.96	25.3	6.06	25.3	6.17	25.3	6.36
	3.0	2.2	26.9	5.81	27.8	6.18	27.8	6.28	27.8	6.38	27.7	6.47	27.7	6.65
	5.0	4.1	31.1	6.54	34.5	7.46	32.7	7.17	31.4	7.01	30.2	6.83	28.2	6.56
	7.0	6.0	33.9	6.95	35.1	7.39	32.7	6.97	31.5	6.07	30.2	6.62	28.5	6.26
	9.0	7.9	33.9	6.76	35.2	7.18	32.7	6.75	31.5	6.60	30.5	6.40	28.5	5.89
	11.0	9.8	33.9	6.56	35.2	6.95	32.7	6.52	31.5	6.25	30.5	6.01	28.5	5.55
	13.0	11.8	34.6	6.47	35.2	6.72	32.7	6.12	31.5	5.86	30.5	5.65	28.5	5.20
	15.0	13.7	36.3	6.58	35.2	6.33	32.7	5.76	31.5	5.53	30.5	5.32	28.5	4.91
	18.0	16.8	36.3	6.24	35.1	6.01	32.7	5.46	31.5	5.26	30.5	5.03	28.5	4.67
20.0	18.5	36.3	5.93	35.1	5.74	32.7	5.21	31.5	5.02	30.5	4.78	28.5	4.46	
24.0	20.5	36.3	5.68	35.1	5.53	32.7	5.01	31.5	4.83	30.5	4.56	28.5	4.30	
120%	-19.8	-20.0	20.5	5.30	20.5	5.62	20.4	5.87	20.4	6.03	20.4	6.20	20.3	6.55
	-18.8	-19.0	20.7	5.37	20.7	5.69	20.6	5.84	20.6	6.10	20.6	6.25	20.5	6.59
	-16.7	-17.0	21.1	5.46	21.0	5.76	20.9	5.95	21.0	6.15	20.9	6.29	20.9	6.63
	-13.7	-15.0	21.4	5.54	21.4	5.82	21.3	6.03	21.3	6.18	21.3	6.34	21.3	6.64
	-11.8	-13.0	21.7	5.61	21.7	5.85	21.7	6.04	21.6	6.18	21.7	6.36	21.6	6.61
	-9.8	-11.0	22.1	5.65	22.0	5.89	22.1	6.06	22.1	6.22	22.0	6.34	22.0	6.61
	-9.5	-10.0	22.3	5.66	22.2	5.89	22.2	6.07	22.2	6.20	22.2	6.27	22.1	6.57
	-8.5	-9.1	22.5	5.69	22.5	5.92	22.4	6.05	22.4	6.19	22.4	6.32	22.3	6.57
	-7.0	-7.6	22.7	5.69	22.7	5.90	22.7	6.04	22.6	6.14	22.6	6.29	22.6	6.49
	-5.0	-5.6	24.5	6.02	24.5	6.23	24.4	6.36	24.4	6.49	24.5	6.61	24.4	6.83
	-3.0	-3.7	24.8	6.00	24.8	6.18	24.7	6.29	24.8	6.40	24.8	6.54	24.7	6.72
	0.0	-0.7	25.4	5.92	25.3	6.07	25.3	6.25	25.3	6.27	25.3	6.39	25.3	6.55
	3.0	2.2	27.7	6.22	27.8	6.40	27.7	6.46	27.7	6.57	27.7	6.66	26.4	6.47
	5.0	4.1	34.5	7.52	32.4	7.26	30.1	6.82	29.0	6.66	28.3	6.58	26.4	6.08
	7.0	6.0	34.7	7.36	32.5	7.02	30.2	6.61	29.2	6.43	28.3	6.18	26.4	5.72
	9.0	7.9	34.8	7.15	32.5	6.83	30.2	6.29	29.2	6.04	28.3	5.81	26.4	5.38
	11.0	9.8	34.8	6.93	32.5	6.52	30.2	5.92	29.2	5.69	28.3	5.47	26.4	5.08
	13.0	11.8	34.8	6.62	32.5	6.11	30.2	5.55	29.2	5.34	28.3	5.15	26.4	4.77
	15.0	13.7	34.8	6.23	32.5	5.76	30.2	5.24	29.2	5.04	28.3	4.85	26.4	4.51
	18.0	16.8	34.8	5.89	32.5	5.45	30.2	4.98	29.2	4.78	28.3	4.60	26.4	4.27
20.0	18.5	34.8	5.58	32.5	5.20	30.2	4.77	29.2	4.56	28.3	4.38	26.4	4.07	
24.0	20.5	34.8	5.31	32.5	4.98	30.2	4.60	29.2	4.37	28.3	4.21	26.4	3.90	

GMV6 HR DC Inverter VRF Units Technical Sales Guide

TC—Total capacity of outdoor unit; PI—Power input of outdoor unit														
combination	outdoor air temp		indoor air temperature °C DB											
			16		18		20		21		22		24	
	°C DB	°C WB	TC	PI	TC	PI	TC	PI	TC	PI	TC	PI	TC	PI
			kW	kW	kW	kW	kW	kW	kW	kW	kW	kW	kW	kW
110%	-19.8	-20.0	20.5	5.78	20.4	6.07	20.4	6.29	20.4	6.45	20.3	6.59	20.3	6.95
	-18.8	-19.0	20.7	5.83	20.6	6.09	20.5	6.30	20.6	6.46	20.5	6.63	20.5	6.93
	-16.7	-17.0	21.0	5.89	20.9	6.17	20.9	6.33	20.9	6.51	20.9	6.66	20.9	6.97
	-13.7	-15.0	21.4	5.95	21.3	6.21	21.2	6.37	21.3	6.52	21.3	6.68	21.2	6.95
	-11.8	-13.0	21.7	6.00	21.7	6.22	21.6	6.39	21.6	6.50	21.6	6.67	21.5	6.91
	-9.8	-11.0	22.0	6.01	22.0	6.23	22.0	6.36	21.9	6.50	22.0	6.63	21.9	6.85
	-9.5	-10.0	22.2	6.00	22.2	6.23	22.2	6.37	22.1	6.47	22.1	6.60	22.1	6.83
	-8.5	-9.1	22.4	6.01	22.4	6.22	22.4	6.34	22.3	6.44	22.3	6.59	22.3	6.79
	-7.0	-7.6	22.6	6.01	22.6	6.17	22.6	6.30	22.6	6.40	22.6	6.44	22.5	6.73
	-5.0	-5.6	24.5	6.33	24.4	6.52	24.4	6.62	24.4	6.74	24.4	6.55	23.7	6.89
	-3.0	-3.7	24.8	6.28	24.7	6.43	24.7	6.53	24.7	6.63	24.7	6.25	23.7	6.67
	0.0	-0.7	25.3	6.17	25.3	6.31	25.3	6.40	25.2	6.47	26.0	6.48	24.0	6.33
	3.0	2.2	27.7	6.45	27.7	6.61	27.7	6.66	27.0	6.59	25.9	6.30	24.0	5.77
	5.0	4.1	31.9	7.20	29.8	6.86	27.7	6.39	26.6	6.11	26.0	5.93	24.0	5.43
	7.0	6.0	31.9	6.99	29.8	6.62	27.7	6.01	26.6	5.76	26.0	5.58	24.0	5.11
	9.0	7.9	31.9	6.77	29.8	6.23	27.8	5.66	26.7	5.42	26.0	5.25	24.0	4.81
	11.0	9.8	31.9	6.36	29.8	5.86	27.8	5.33	26.7	5.11	26.0	4.95	24.0	4.54
	13.0	11.8	31.9	5.97	29.8	5.50	27.8	5.01	26.7	4.81	26.0	4.66	24.0	4.28
	15.0	13.7	31.9	5.62	29.8	5.19	27.8	4.74	26.7	4.54	26.0	4.41	24.0	4.05
	18.0	16.8	31.9	5.32	29.8	4.92	27.8	4.32	26.7	4.31	26.0	4.20	24.0	3.85
20.0	18.5	31.9	5.05	29.8	4.68	27.8	4.10	26.7	4.10	26.0	4.03	24.0	3.69	
24.0	20.5	31.9	4.82	29.8	4.47	27.8	3.91	26.7	3.93	26.0	3.88	24.0	3.55	
100%	-19.8	-20.0	20.4	6.23	20.4	6.53	20.3	6.67	20.2	6.82	20.2	6.96	20.1	7.27
	-18.8	-19.0	20.5	6.28	20.5	6.50	20.5	6.69	20.4	6.82	20.4	6.99	20.3	7.25
	-16.7	-17.0	20.9	6.31	20.8	6.56	20.7	6.67	20.7	6.82	20.7	6.97	20.6	7.21
	-13.7	-15.0	21.2	6.34	21.2	6.57	21.2	6.69	21.1	6.84	21.0	6.94	20.9	7.20
	-11.8	-13.0	21.6	6.36	21.5	6.54	21.5	6.68	21.4	6.79	21.3	6.64	21.3	7.13
	-9.8	-11.0	21.9	6.34	21.8	6.54	21.8	6.63	21.8	6.74	21.6	6.84	21.3	6.92
	-9.5	-10.0	22.1	6.32	22.1	6.53	22.0	6.60	22.0	6.75	21.8	6.79	21.3	6.85
	-8.5	-9.1	22.2	6.31	22.2	6.47	22.2	6.58	22.1	6.67	21.9	6.76	21.3	6.74
	-7.0	-7.6	22.4	6.27	22.4	6.44	22.4	6.51	22.3	6.60	22.2	6.67	21.3	6.60
	-5.0	-5.6	24.0	6.54	24.0	6.70	24.0	6.77	23.9	6.88	23.5	6.86	22.1	6.61
	-3.0	-3.7	24.4	6.46	24.3	6.59	24.3	6.68	24.1	6.71	23.5	6.64	22.1	6.25
	0.0	-0.7	24.8	6.31	24.8	6.41	24.8	6.48	24.3	6.38	23.5	6.13	22.1	5.69
	3.0	2.2	27.1	6.56	26.9	6.64	25.0	6.00	24.3	5.80	23.5	5.59	22.1	5.18
	5.0	4.1	28.8	6.75	26.9	6.23	25.0	5.65	24.3	5.46	23.5	5.26	22.1	4.88
	7.0	6.0	28.8	6.37	26.9	5.86	25.0	5.24	24.3	5.15	23.5	4.96	22.1	4.60
	9.0	7.9	28.8	5.98	26.9	5.51	25.0	4.98	24.3	4.85	23.5	4.67	22.1	4.34
	11.0	9.8	28.8	5.63	26.9	5.20	25.0	4.70	24.3	4.57	23.5	4.41	22.1	4.11
	13.0	11.8	28.8	5.29	26.9	4.89	25.0	4.43	24.3	4.31	23.5	4.16	22.1	3.88
	15.0	13.7	28.8	4.99	26.9	4.61	25.0	4.19	24.3	4.08	23.5	3.93	22.1	3.67
	18.0	16.8	28.8	4.70	26.9	4.40	25.0	4.05	24.3	3.87	23.5	3.72	22.1	3.50
20.0	18.5	28.8	4.44	26.9	4.22	25.0	3.89	24.3	3.70	23.5	3.55	22.1	3.36	
24.0	20.5	28.8	4.20	26.9	4.08	25.0	3.74	24.3	3.56	23.5	3.41	22.1	3.25	

TC—Total capacity of outdoor unit; PI—Power input of outdoor unit														
combination	outdoor air temp		indoor air temperature °C DB											
			16		18		20		21		22		24	
	°C DB	°C WB	TC	PI	TC	PI	TC	PI	TC	PI	TC	PI	TC	PI
			kW	kW	kW	kW	kW	kW	kW	kW	kW	kW	kW	kW
90%	-19.8	-20.0	20.3	6.71	20.2	6.95	20.2	7.05	20.2	7.24	20.2	7.40	19.2	7.26
	-18.8	-19.0	20.5	6.74	20.4	6.96	20.4	7.08	20.4	7.23	20.4	7.38	19.2	7.21
	-16.7	-17.0	20.8	6.76	20.8	6.98	20.8	7.09	20.7	7.21	20.8	7.38	19.2	7.06
	-13.7	-15.0	21.2	6.75	21.1	6.97	21.1	7.06	21.1	7.14	21.0	7.31	19.3	6.90
	-11.8	-13.0	21.5	6.74	21.4	6.91	21.5	7.03	21.4	7.14	21.0	7.12	19.3	6.74
	-9.8	-11.0	21.9	6.71	21.9	6.87	21.8	6.95	21.9	7.08	21.1	6.93	19.3	6.55
	-9.5	-10.0	22.1	6.67	22.0	6.86	22.0	6.91	21.9	7.03	21.1	6.86	19.4	6.49
	-8.5	-9.1	22.2	6.64	22.1	6.79	22.1	6.88	21.9	6.92	21.1	6.75	19.7	6.46
	-7.0	-7.6	22.4	6.58	22.4	6.73	22.3	6.80	21.9	6.76	21.0	6.58	19.7	6.16
	-5.0	-5.6	24.0	6.84	23.9	6.99	22.6	6.65	21.8	6.49	21.0	6.28	19.7	5.80
	-3.0	-3.7	24.3	6.74	24.3	6.11	22.6	6.40	21.8	6.15	21.0	5.91	19.7	5.47
	0.0	-0.7	24.8	6.52	24.3	5.71	22.6	5.81	21.8	5.59	21.0	5.38	19.7	4.97
	3.0	2.2	26.0	6.33	24.3	5.83	22.6	5.30	21.8	5.10	21.0	4.91	19.7	4.55
	5.0	4.1	26.0	5.95	24.3	5.49	22.6	5.00	21.8	4.81	21.0	4.63	19.7	4.29
	7.0	6.0	26.0	5.60	24.3	5.17	22.6	4.71	21.8	4.54	21.0	4.37	19.7	4.06
	9.0	7.9	26.0	5.28	24.3	4.87	22.6	4.44	21.8	4.29	21.0	4.13	19.7	3.83
	11.0	9.8	26.0	4.97	24.3	4.59	22.6	4.20	21.8	4.05	21.0	3.90	19.7	3.63
	13.0	11.8	26.0	4.68	24.3	4.33	22.6	3.96	21.8	3.82	21.0	3.69	19.7	3.43
	15.0	13.7	26.0	4.42	24.3	4.09	22.6	3.76	21.8	3.61	21.0	3.49	19.7	3.26
	18.0	16.8	26.0	4.17	24.3	3.87	22.6	3.57	21.7	3.41	21.0	3.31	19.7	3.10
20.0	18.5	26.0	3.94	24.2	3.65	22.6	3.39	21.7	3.21	21.0	3.15	19.7	2.96	
24.0	20.5	26.0	3.72	24.3	3.45	22.6	3.21	21.7	3.03	21.0	2.99	19.7	2.82	
80%	-19.8	-20.0	20.2	7.19	20.2	7.41	20.1	7.46	19.4	7.31	18.7	7.21	17.5	6.95
	-18.8	-19.0	20.4	7.21	20.4	7.40	20.1	7.42	19.4	7.27	18.7	7.12	17.5	6.90
	-16.7	-17.0	20.8	7.20	20.7	7.40	20.2	7.27	19.4	7.11	18.7	6.96	17.6	6.78
	-13.7	-15.0	21.1	7.16	21.1	7.35	20.2	7.11	19.4	6.94	18.7	6.83	17.6	6.60
	-11.8	-13.0	21.4	7.13	21.4	7.28	20.2	6.95	19.4	6.78	18.7	6.64	17.6	6.29
	-9.8	-11.0	21.8	7.05	21.7	7.19	20.2	6.76	19.5	6.59	18.8	6.41	17.6	5.94
	-9.5	-10.0	22.0	7.00	21.7	7.10	20.2	6.65	19.5	6.48	18.8	6.23	17.6	5.77
	-8.5	-9.1	22.1	6.97	21.7	6.99	20.2	6.56	19.5	6.33	18.8	6.06	17.6	5.61
	-7.0	-7.6	22.3	6.89	21.7	6.83	20.2	6.30	19.4	6.03	18.7	5.78	17.6	5.39
	-5.0	-5.6	23.1	6.15	21.6	6.51	20.1	5.88	19.4	5.67	18.7	5.44	17.6	5.06
	-3.0	-3.7	23.1	5.95	21.6	6.13	20.1	5.54	19.4	5.37	18.7	5.13	17.6	4.78
	0.0	-0.7	23.1	6.05	21.6	5.56	20.1	5.05	19.4	4.88	18.7	4.68	17.6	4.36
	3.0	2.2	23.1	5.51	21.6	5.07	20.1	4.62	19.4	4.46	18.7	4.28	17.6	4.00
	5.0	4.1	23.1	5.19	21.6	4.78	20.1	4.36	19.4	4.21	18.7	4.05	17.6	3.78
	7.0	6.0	23.1	4.89	21.6	4.52	20.1	4.12	19.4	3.98	18.7	3.83	17.6	3.58
	9.0	7.9	23.1	4.61	21.6	4.26	20.1	3.91	19.4	3.76	18.7	3.62	17.6	3.39
	11.0	9.8	23.1	4.36	21.6	4.03	20.1	3.69	19.4	3.56	18.7	3.43	17.6	3.22
	13.0	11.8	23.1	4.11	21.6	3.80	20.1	3.49	19.4	3.37	18.7	3.24	17.6	3.04
	15.0	13.7	23.1	3.88	21.6	3.60	20.1	3.31	19.4	3.20	18.7	3.08	17.6	2.89
	18.0	16.8	23.2	3.71	21.6	3.43	20.1	3.15	19.4	3.03	18.7	2.92	17.6	2.76
20.0	18.5	23.2	3.57	21.6	3.29	20.1	3.01	19.4	2.89	18.7	2.78	17.6	2.63	
24.0	20.5	23.2	3.46	21.6	3.18	20.1	2.89	19.4	2.77	18.7	2.66	17.6	2.52	

GMV6 HR DC Inverter VRF Units Technical Sales Guide

TC—Total capacity of outdoor unit; PI—Power input of outdoor unit														
combination	outdoor air temp		indoor air temperature °C DB											
			16		18		20		21		22		24	
	°C DB	°C WB	TC	PI	TC	PI	TC	PI	TC	PI	TC	PI	TC	PI
		kW	kW	kW	kW	kW	kW	kW	kW	kW	kW	kW	kW	kW
70%	-19.8	-20.0	20.1	7.64	18.9	7.39	17.7	6.93	17.0	6.77	16.4	6.62	15.5	6.39
	-18.8	-19.0	20.3	7.65	18.9	7.31	17.7	6.88	17.0	6.72	16.4	6.57	15.5	6.25
	-16.7	-17.0	20.3	7.49	19.0	7.15	17.7	6.72	17.0	6.56	16.4	6.40	15.5	5.97
	-13.7	-15.0	20.3	7.32	19.0	7.01	17.7	6.56	17.0	6.22	16.4	6.09	15.5	5.67
	-11.8	-13.0	20.3	7.14	19.0	6.80	17.7	6.26	17.0	6.02	16.4	5.78	15.5	5.38
	-9.8	-11.0	20.4	6.94	19.0	6.55	17.8	5.93	17.1	5.70	16.4	5.47	15.5	5.09
	-9.5	-10.0	20.4	6.83	19.0	6.36	17.8	5.76	17.1	5.54	16.4	5.32	15.5	4.95
	-8.5	-9.1	20.4	6.73	19.0	6.19	17.8	5.61	17.1	5.40	16.4	5.18	15.5	4.83
	-7.0	-7.6	20.3	6.41	19.0	5.90	17.7	5.36	17.0	5.16	16.4	4.95	15.5	4.62
	-5.0	-5.6	20.2	5.99	18.9	5.52	17.6	5.02	16.9	4.83	16.4	4.67	15.5	4.36
	-3.0	-3.7	20.2	5.64	18.9	5.21	17.6	4.74	16.9	4.56	16.4	4.41	15.5	4.13
	0.0	-0.7	20.2	5.13	18.9	4.77	17.6	4.33	16.9	4.17	16.4	4.04	15.5	3.78
	3.0	2.2	20.2	4.69	18.9	4.34	17.6	3.97	16.9	3.83	16.4	3.71	15.5	3.47
	5.0	4.1	20.2	4.43	18.9	4.10	17.6	3.76	16.9	3.62	16.4	3.51	15.5	3.29
	7.0	6.0	20.2	4.18	18.9	3.88	17.6	3.56	16.9	3.43	16.4	3.33	15.5	3.12
	9.0	7.9	20.2	3.96	18.9	3.67	17.6	3.37	16.9	3.25	16.4	3.15	15.5	2.96
	11.0	9.8	20.2	3.74	18.9	3.47	17.6	3.20	16.9	3.08	16.4	2.99	15.5	2.81
	13.0	11.8	20.2	3.53	18.9	3.29	17.6	3.03	16.9	2.93	16.4	2.83	15.5	2.67
	15.0	13.7	20.2	3.35	18.9	3.12	17.6	2.87	16.9	2.78	16.4	2.69	15.5	2.54
	18.0	16.8	20.2	3.18	18.9	2.96	17.6	2.73	16.9	2.64	16.4	2.57	15.5	2.43
20.0	18.5	20.2	3.03	18.9	2.82	17.6	2.61	16.9	2.53	16.4	2.46	15.5	2.33	
24.0	20.5	20.2	2.90	18.9	2.69	17.6	2.51	16.9	2.42	16.4	2.37	15.5	2.25	
60%	-19.8	-20.0	17.4	7.05	16.3	6.76	15.1	6.13	14.6	5.90	14.2	5.73	13.3	5.28
	-18.8	-19.0	17.4	7.00	16.3	6.68	15.1	6.01	14.6	5.78	14.2	5.60	13.3	5.17
	-16.7	-17.0	17.4	6.83	16.3	6.41	15.1	5.75	14.6	5.53	14.2	5.35	13.3	4.94
	-13.7	-15.0	17.5	6.61	16.4	6.10	15.2	5.48	14.6	5.27	14.2	5.10	13.3	4.71
	-11.8	-13.0	17.5	6.25	16.4	5.78	15.2	5.20	14.6	5.01	14.2	4.84	13.3	4.48
	-9.8	-11.0	17.5	5.92	16.4	5.47	15.2	4.93	14.7	4.75	14.2	4.59	13.3	4.25
	-9.5	-10.0	17.5	5.75	16.4	5.32	15.2	4.80	14.7	4.62	14.2	4.46	13.3	4.13
	-8.5	-9.1	17.5	5.60	16.4	5.19	15.2	4.68	14.7	4.51	14.2	4.35	13.3	4.03
	-7.0	-7.6	17.5	5.34	16.4	4.95	15.2	4.48	14.6	4.31	14.2	4.17	13.3	3.87
	-5.0	-5.6	17.4	5.01	16.3	4.64	15.1	4.20	14.6	4.05	14.2	3.94	13.3	3.66
	-3.0	-3.7	17.4	4.73	16.3	4.38	15.1	3.99	14.6	3.84	14.2	3.73	13.3	3.47
	0.0	-0.7	17.4	4.32	16.3	4.01	15.1	3.65	14.6	3.52	14.2	3.43	13.3	3.19
	3.0	2.2	17.4	3.96	16.3	3.69	15.1	3.36	14.6	3.24	14.2	3.16	13.3	2.94
	5.0	4.1	17.4	3.74	16.3	3.49	15.1	3.18	14.6	3.07	14.2	3.00	13.3	2.79
	7.0	6.0	17.4	3.54	16.3	3.30	15.1	3.02	14.6	2.92	14.2	2.85	13.3	2.65
	9.0	7.9	17.4	3.36	16.3	3.13	15.1	2.87	14.6	2.77	14.2	2.70	13.3	2.53
	11.0	9.8	17.4	3.18	16.3	2.98	15.1	2.73	14.6	2.63	14.2	2.57	13.3	2.41
	13.0	11.8	17.4	3.01	16.3	2.82	15.1	2.59	14.6	2.50	14.2	2.44	13.3	2.29
	15.0	13.7	17.4	2.87	16.3	2.68	15.1	2.47	14.6	2.38	14.2	2.33	13.3	2.18
	18.0	16.8	17.4	2.74	16.3	2.55	15.1	2.35	14.6	2.28	14.2	2.23	13.3	2.09
20.0	18.5	17.3	2.62	16.3	2.43	15.1	2.26	14.6	2.19	14.2	2.15	13.3	2.01	
24.0	20.5	17.3	2.52	16.3	2.33	15.1	2.17	14.6	2.12	14.2	2.08	13.3	1.94	

TC—Total capacity of outdoor unit; PI—Power input of outdoor unit														
combination	outdoor air temp		indoor air temperature °C DB											
			16		18		20		21		22		24	
	°C DB	°C WB	TC	PI	TC	PI	TC	PI	TC	PI	TC	PI	TC	PI
50%	-19.8	-20.0	14.5	5.93	13.6	5.47	12.7	4.93	12.1	4.75	11.8	4.62	11.0	4.28
	-18.8	-19.0	14.6	5.81	13.6	5.36	12.7	4.84	12.1	4.65	11.8	4.53	11.0	4.20
	-16.7	-17.0	14.6	5.55	13.6	5.12	12.7	4.63	12.1	4.46	11.8	4.34	11.0	4.02
	-13.7	-15.0	14.6	5.29	13.7	4.89	12.7	4.43	12.2	4.26	11.8	4.14	11.0	3.84
	-11.8	-13.0	14.6	5.03	13.7	4.66	12.7	4.21	12.2	4.06	11.8	3.94	11.0	3.66
	-9.8	-11.0	14.6	4.77	13.7	4.41	12.7	4.01	12.2	3.86	11.9	3.77	11.0	3.48
	-9.5	-10.0	14.6	4.64	13.7	4.29	12.7	3.91	12.2	3.76	11.9	3.67	11.0	3.39
	-8.5	-9.1	14.6	4.52	13.7	4.19	12.7	3.81	12.2	3.67	11.9	3.59	11.0	3.31
	-7.0	-7.6	14.6	4.33	13.7	4.03	12.7	3.65	12.2	3.52	11.9	3.45	11.0	3.18
	-5.0	-5.6	14.5	4.06	13.6	3.77	12.6	3.44	12.1	3.32	11.9	3.26	11.0	3.02
	-3.0	-3.7	14.5	3.84	13.6	3.57	12.6	3.26	12.1	3.14	11.9	3.10	11.0	2.87
	0.0	-0.7	14.5	3.53	13.6	3.28	12.6	3.01	12.1	2.90	11.9	2.86	11.0	2.65
	3.0	2.2	14.5	3.25	13.6	3.03	12.6	2.77	12.1	2.68	11.9	2.65	11.0	2.45
	5.0	4.1	14.5	3.08	13.6	2.87	12.6	2.64	12.1	2.55	11.9	2.51	11.0	2.33
	7.0	6.0	14.5	2.93	13.6	2.73	12.6	2.51	12.1	2.42	11.9	2.39	11.0	2.23
	9.0	7.9	14.5	2.78	13.6	2.59	12.6	2.39	12.1	2.31	11.9	2.28	11.0	2.12
	11.0	9.8	14.5	2.64	13.6	2.47	12.6	2.28	12.1	2.20	11.9	2.18	11.0	2.03
13.0	11.8	14.5	2.51	13.6	2.34	12.6	2.17	12.1	2.10	11.9	2.07	11.0	1.93	
15.0	13.7	14.5	2.39	13.6	2.24	12.6	2.07	12.1	2.00	11.9	1.98	11.0	1.84	
18.0	16.8	14.5	2.28	13.5	2.13	12.6	1.99	12.1	1.92	11.9	1.89	11.0	1.76	
20.0	18.5	14.5	2.16	13.5	2.03	12.6	1.91	12.1	1.85	11.9	1.82	11.0	1.68	
24.0	20.5	14.5	2.06	13.5	1.95	12.6	1.78	12.1	1.79	11.9	1.74	11.0	1.61	

GMV-VQ280WM/C-X

TC—Total capacity of outdoor unit; PI—Power input of outdoor unit														
combination	outdoor air temp		indoor air temperature °C DB											
			16		18		20		21		22		24	
	°C DB	°C WB	TC	PI	TC	PI	TC	PI	TC	PI	TC	PI	TC	PI
135%	-19.8	-20.0	26.0	8.86	25.9	9.49	25.8	10.02	25.7	10.32	25.7	10.19	25.7	11.35
	-18.8	-19.0	26.2	9.00	26.1	9.63	26.1	10.11	26.1	10.47	26.0	10.76	25.9	11.42
	-16.7	-17.0	26.6	9.22	26.5	9.80	26.5	10.27	26.5	10.55	26.4	10.87	26.3	11.51
	-13.7	-15.0	27.1	9.42	27.0	9.97	26.9	10.39	26.9	10.69	26.9	11.02	26.8	11.56
	-11.8	-13.0	27.5	9.59	27.4	10.08	27.3	10.45	27.3	10.79	27.3	11.04	27.3	11.63
	-9.8	-11.0	27.9	9.72	27.8	10.21	27.8	10.55	27.8	10.82	27.8	11.10	27.8	11.61
	-9.5	-10.0	28.1	9.76	28.1	10.22	28.1	10.58	28.0	10.81	28.0	11.11	28.0	11.56
	-8.5	-9.1	28.4	9.83	28.3	10.27	28.3	10.57	28.3	10.84	28.2	11.05	28.2	11.57
	-7.0	-7.6	28.7	9.87	28.6	10.26	28.6	10.58	28.6	10.79	28.6	11.06	28.5	11.52
	-5.0	-5.6	31.0	10.51	30.9	10.71	30.9	11.22	30.9	11.43	30.8	11.66	30.7	12.06
	-3.0	-3.7	31.4	10.50	31.3	10.88	31.3	11.11	31.3	11.35	31.2	11.53	31.1	11.93
	0.0	-0.7	32.0	10.42	32.0	10.72	31.9	10.92	31.9	11.11	31.9	11.32	31.9	11.67
	3.0	2.2	35.1	11.01	35.1	11.33	35.0	11.52	35.0	11.70	35.0	11.87	34.9	12.20
	5.0	4.1	43.5	13.32	43.4	13.68	41.2	13.14	39.6	12.86	38.0	12.52	35.5	12.02
	7.0	6.0	47.4	14.16	44.3	13.55	41.2	12.77	39.6	11.14	38.1	12.14	35.9	11.49
	9.0	7.9	47.5	13.77	44.3	13.17	41.2	12.38	39.7	12.09	38.4	11.73	35.9	10.80
	11.0	9.8	47.5	13.36	44.3	12.75	41.2	11.96	39.7	11.46	38.4	11.02	35.9	10.17
13.0	11.8	47.5	12.93	44.3	12.33	41.2	11.21	39.7	10.74	38.4	10.35	35.9	9.54	
15.0	13.7	47.5	12.54	44.3	11.62	41.2	10.57	39.7	10.14	38.4	9.76	35.9	9.01	
18.0	16.8	47.4	11.86	44.2	11.03	41.2	10.01	39.7	9.64	38.4	9.22	35.9	8.56	
20.0	18.5	47.4	11.28	44.2	10.54	41.2	9.56	39.7	9.21	38.4	8.76	35.9	8.18	
24.0	20.5	47.4	10.79	44.2	10.13	41.2	9.19	39.7	8.85	38.4	8.37	35.9	7.88	

GMV6 HR DC Inverter VRF Units Technical Sales Guide

TC—Total capacity of outdoor unit; PI—Power input of outdoor unit														
combination	outdoor air temp		indoor air temperature °C DB											
			16		18		20		21		22		24	
	°C DB	°C WB	TC kW	PI kW	TC kW	PI kW	TC kW	PI kW	TC kW	PI kW	TC kW	PI kW	TC kW	PI kW
120%	-19.8	-20.0	25.9	9.72	25.8	10.31	25.7	10.77	25.7	11.06	25.7	11.37	25.6	12.02
	-18.8	-19.0	26.1	9.85	26.0	10.43	26.0	10.70	26.0	11.18	25.9	11.47	25.8	12.09
	-16.7	-17.0	26.5	10.01	26.5	10.57	26.4	10.91	26.4	11.27	26.3	11.53	26.4	12.16
	-13.7	-15.0	27.0	10.16	26.9	10.67	26.9	11.06	26.9	11.33	26.9	11.62	26.8	12.17
	-11.8	-13.0	27.4	10.29	27.3	10.73	27.3	11.08	27.3	11.34	27.3	11.65	27.2	12.12
	-9.8	-11.0	27.8	10.37	27.8	10.81	27.8	11.11	27.8	11.40	27.8	11.62	27.7	12.12
	-9.5	-10.0	28.1	10.38	28.0	10.81	28.0	11.12	28.0	11.36	28.0	11.49	27.9	12.05
	-8.5	-9.1	28.3	10.43	28.3	10.86	28.3	11.10	28.2	11.34	28.2	11.60	28.1	12.04
	-7.0	-7.6	28.6	10.44	28.6	10.81	28.6	11.07	28.5	11.26	28.5	11.53	28.4	11.90
	-5.0	-5.6	30.9	11.05	30.8	11.43	30.8	11.67	30.8	11.89	30.8	12.12	30.7	12.53
	-3.0	-3.7	31.3	11.01	31.2	11.33	31.2	11.52	31.2	11.73	31.2	11.98	31.2	12.33
	0.0	-0.7	32.0	10.87	31.9	11.14	31.9	11.46	31.9	11.49	31.9	11.71	31.8	12.02
	3.0	2.2	35.0	11.41	35.0	11.73	34.9	11.85	34.9	12.05	34.9	12.21	33.3	11.86
	5.0	4.1	43.4	13.80	40.9	13.31	38.0	12.51	36.5	12.21	35.6	12.06	33.3	11.15
	7.0	6.0	43.8	13.51	40.9	12.88	38.0	12.12	36.8	11.79	35.6	11.33	33.3	10.49
	9.0	7.9	43.8	13.12	40.9	12.53	38.1	11.53	36.8	11.08	35.6	10.66	33.3	9.87
	11.0	9.8	43.8	12.70	40.9	11.95	38.1	10.85	36.8	10.43	35.6	10.04	33.3	9.31
	13.0	11.8	43.8	12.14	40.9	11.21	38.1	10.18	36.8	9.80	35.6	9.44	33.3	8.76
	15.0	13.7	43.8	11.43	40.9	10.56	38.1	9.61	36.8	9.24	35.6	8.90	33.3	8.27
	18.0	16.8	43.8	10.79	40.9	9.99	38.1	9.14	36.8	8.76	35.6	8.43	33.3	7.83
20.0	18.5	43.8	10.23	40.9	9.53	38.1	8.74	36.8	8.35	35.6	8.04	33.3	7.46	
24.0	20.5	43.8	9.73	40.9	9.14	38.1	8.43	36.8	8.01	35.6	7.72	33.3	7.15	
110%	-19.8	-20.0	25.8	10.59	25.7	11.14	25.7	11.52	25.7	11.83	25.6	12.09	25.6	12.74
	-18.8	-19.0	26.0	10.69	26.0	11.18	25.9	11.54	25.9	11.84	25.8	12.16	25.8	12.70
	-16.7	-17.0	26.5	10.81	26.4	11.32	26.3	11.60	26.3	11.94	26.3	12.21	26.3	12.78
	-13.7	-15.0	26.9	10.91	26.8	11.39	26.8	11.68	26.8	11.96	26.8	12.24	26.7	12.75
	-11.8	-13.0	27.3	11.00	27.3	11.42	27.3	11.70	27.2	11.91	27.2	12.23	27.1	12.67
	-9.8	-11.0	27.8	11.02	27.7	11.43	27.7	11.67	27.7	11.92	27.7	12.16	27.6	12.56
	-9.5	-10.0	28.0	11.00	28.0	11.43	27.9	11.67	27.9	11.86	27.9	12.09	27.8	12.52
	-8.5	-9.1	28.2	11.03	28.2	11.41	28.2	11.63	28.1	11.81	28.1	12.09	28.1	12.45
	-7.0	-7.6	28.5	11.01	28.5	11.32	28.5	11.56	28.4	11.74	28.4	11.82	28.4	12.35
	-5.0	-5.6	30.8	11.61	30.8	11.96	30.7	12.14	30.7	12.36	30.7	12.01	29.9	12.63
	-3.0	-3.7	31.2	11.52	31.2	11.80	31.1	11.97	31.1	12.16	31.2	11.45	29.9	12.22
	0.0	-0.7	31.9	11.31	31.9	11.58	31.9	11.73	31.8	11.86	32.7	11.89	30.3	11.61
	3.0	2.2	34.9	11.83	34.9	12.13	34.8	12.21	34.0	12.08	32.7	11.56	30.3	10.57
	5.0	4.1	40.2	13.22	37.5	12.59	34.9	11.71	33.5	11.21	32.7	10.88	30.3	9.95
	7.0	6.0	40.2	12.82	37.5	12.14	34.9	11.01	33.6	10.55	32.7	10.23	30.3	9.36
	9.0	7.9	40.2	12.41	37.6	11.43	35.0	10.38	33.6	9.95	32.7	9.63	30.3	8.83
	11.0	9.8	40.2	11.67	37.6	10.75	35.0	9.78	33.6	9.38	32.7	9.08	30.3	8.33
	13.0	11.8	40.2	10.95	37.6	10.08	35.0	9.19	33.6	8.82	32.7	8.55	30.3	7.85
	15.0	13.7	40.2	10.32	37.6	9.51	35.0	8.69	33.6	8.33	32.7	8.09	30.3	7.43
	18.0	16.8	40.2	9.75	37.6	9.03	35.0	7.93	33.6	7.90	32.7	7.70	30.3	7.07
20.0	18.5	40.2	9.25	37.6	8.58	35.0	7.52	33.6	7.52	32.7	7.38	30.3	6.76	
24.0	20.5	40.2	8.83	37.6	8.19	35.0	7.17	33.6	7.20	32.7	7.11	30.3	6.51	

TC—Total capacity of outdoor unit; PI—Power input of outdoor unit														
combination	outdoor air temp		indoor air temperature °C DB											
			16		18		20		21		22		24	
	°C DB	°C WB	TC kW	PI kW	TC kW	PI kW	TC kW	PI kW	TC kW	PI kW	TC kW	PI kW	TC kW	PI kW
100%	-19.8	-20.0	25.7	11.43	25.7	11.98	25.6	12.23	25.5	12.51	25.5	12.77	25.4	13.32
	-18.8	-19.0	25.9	11.51	25.8	11.93	25.8	12.27	25.7	12.50	25.7	12.82	25.6	13.29
	-16.7	-17.0	26.3	11.58	26.2	12.03	26.1	12.23	26.1	12.50	26.1	12.78	26.0	13.22
	-13.7	-15.0	26.8	11.62	26.7	12.05	26.7	12.27	26.6	12.54	26.5	12.72	26.4	13.20
	-11.8	-13.0	27.2	11.67	27.1	12.00	27.1	12.25	27.0	12.45	26.9	12.18	26.8	13.07
	-9.8	-11.0	27.6	11.63	27.5	11.99	27.5	12.16	27.4	12.35	27.3	12.53	26.8	12.70
	-9.5	-10.0	27.8	11.59	27.8	11.98	27.7	12.10	27.7	12.37	27.5	12.45	26.8	12.56
	-8.5	-9.1	28.0	11.57	27.9	11.87	27.9	12.06	27.8	12.23	27.7	12.40	26.8	12.36
	-7.0	-7.6	28.3	11.49	28.3	11.81	28.2	11.94	28.1	12.11	28.0	12.23	26.8	12.10
	-5.0	-5.6	30.3	11.99	30.2	12.28	30.2	12.42	30.1	12.62	29.6	12.57	27.8	12.13
	-3.0	-3.7	30.7	11.86	30.6	12.09	30.6	12.24	30.3	12.30	29.6	12.17	27.8	11.47
	0.0	-0.7	31.3	11.57	31.2	11.76	31.2	11.88	30.6	11.69	29.6	11.24	27.8	10.43
	3.0	2.2	34.2	12.03	33.9	12.17	31.5	11.00	30.6	10.63	29.6	10.24	27.8	9.49
	5.0	4.1	36.3	12.37	33.9	11.44	31.5	10.35	30.6	10.02	29.6	9.65	27.8	8.96
	7.0	6.0	36.3	11.68	33.9	10.75	31.5	9.30	30.6	9.44	29.6	9.09	27.8	8.44
	9.0	7.9	36.3	10.97	33.9	10.12	31.5	9.13	30.6	8.89	29.6	8.57	27.8	7.97
	11.0	9.8	36.3	10.33	33.9	9.53	31.5	8.62	30.6	8.39	29.6	8.09	27.8	7.53
	13.0	11.8	36.3	9.70	33.9	8.96	31.5	8.12	30.6	7.91	29.6	7.63	27.8	7.11
	15.0	13.7	36.3	9.15	33.9	8.46	31.5	7.68	30.6	7.48	29.6	7.21	27.8	6.73
	18.0	16.8	36.3	8.63	33.9	8.08	31.5	7.43	30.6	7.10	29.6	6.83	27.8	6.41
20.0	18.5	36.3	8.14	33.9	7.74	31.5	7.13	30.6	6.78	29.6	6.51	27.8	6.16	
24.0	20.5	36.3	7.70	33.9	7.49	31.5	6.85	30.6	6.52	29.6	6.25	27.8	5.96	
90%	-19.8	-20.0	25.6	12.31	25.5	12.75	25.4	12.93	25.5	13.27	25.5	13.56	24.2	13.30
	-18.8	-19.0	25.8	12.36	25.7	12.76	25.7	12.98	25.7	13.26	25.7	13.53	24.2	13.23
	-16.7	-17.0	26.2	12.39	26.2	12.81	26.2	13.00	26.1	13.22	26.2	13.53	24.2	12.94
	-13.7	-15.0	26.7	12.39	26.6	12.78	26.6	12.94	26.6	13.09	26.5	13.40	24.3	12.65
	-11.8	-13.0	27.1	12.37	27.0	12.68	27.0	12.88	27.0	13.08	26.5	13.05	24.3	12.35
	-9.8	-11.0	27.6	12.30	27.6	12.61	27.5	12.74	27.5	12.98	26.6	12.71	24.3	12.01
	-9.5	-10.0	27.8	12.24	27.8	12.59	27.7	12.66	27.7	12.89	26.6	12.57	24.5	11.90
	-8.5	-9.1	27.9	12.19	27.9	12.45	27.9	12.61	27.7	12.68	26.6	12.37	24.8	11.84
	-7.0	-7.6	28.2	12.06	28.2	12.35	28.2	12.46	27.6	12.39	26.5	12.07	24.8	11.30
	-5.0	-5.6	30.2	12.54	30.2	12.82	28.5	12.18	27.4	11.89	26.5	11.51	24.8	10.63
	-3.0	-3.7	30.6	12.36	30.6	11.21	28.5	11.73	27.4	11.28	26.5	10.84	24.8	10.02
	0.0	-0.7	31.2	11.97	30.6	10.46	28.5	10.66	27.4	10.25	26.5	9.86	24.8	9.12
	3.0	2.2	32.7	11.61	30.6	10.70	28.5	9.72	27.4	9.36	26.5	9.00	24.8	8.34
	5.0	4.1	32.7	10.92	30.6	10.06	28.5	9.17	27.4	8.82	26.5	8.50	24.8	7.87
	7.0	6.0	32.7	10.27	30.6	9.48	28.5	8.64	27.4	8.33	26.5	8.02	24.8	7.44
	9.0	7.9	32.7	9.68	30.6	8.92	28.5	8.15	27.4	7.86	26.5	7.57	24.8	7.03
	11.0	9.8	32.7	9.11	30.6	8.42	28.5	7.71	27.4	7.43	26.5	7.16	24.8	6.66
	13.0	11.8	32.7	8.58	30.6	7.94	28.5	7.27	27.4	7.01	26.5	6.76	24.8	6.29
	15.0	13.7	32.7	8.11	30.6	7.50	28.5	6.89	27.4	6.62	26.5	6.41	24.8	5.97
	18.0	16.8	32.7	7.65	30.6	7.09	28.5	6.54	27.4	6.25	26.5	6.08	24.8	5.68
20.0	18.5	32.7	7.23	30.6	6.69	28.5	6.21	27.4	5.89	26.5	5.77	24.8	5.42	
24.0	20.5	32.7	6.83	30.6	6.33	28.5	5.89	27.4	5.56	26.5	5.48	24.8	5.18	

GMV6 HR DC Inverter VRF Units Technical Sales Guide

TC—Total capacity of outdoor unit; PI—Power input of outdoor unit														
combination	outdoor air temp		indoor air temperature °C DB											
			16		18		20		21		22		24	
	°C DB	°C WB	TC kW	PI kW	TC kW	PI kW	TC kW	PI kW	TC kW	PI kW	TC kW	PI kW	TC kW	PI kW
80%	-19.8	-20.0	25.5	13.19	25.4	13.59	25.4	13.68	24.4	13.40	23.5	13.21	22.0	12.73
	-18.8	-19.0	25.7	13.22	25.7	13.57	25.4	13.60	24.4	13.32	23.5	13.05	22.0	12.64
	-16.7	-17.0	26.2	13.20	26.1	13.57	25.4	13.33	24.4	13.03	23.6	12.77	22.2	12.43
	-13.7	-15.0	26.6	13.14	26.5	13.49	25.5	13.03	24.5	12.72	23.6	12.52	22.2	12.10
	-11.8	-13.0	27.0	13.07	26.9	13.35	25.5	12.73	24.5	12.43	23.6	12.17	22.2	11.53
	-9.8	-11.0	27.5	12.92	27.4	13.18	25.5	12.38	24.5	12.07	23.6	11.75	22.2	10.89
	-9.5	-10.0	27.7	12.84	27.4	13.03	25.5	12.18	24.5	11.89	23.6	11.42	22.2	10.57
	-8.5	-9.1	27.9	12.79	27.4	12.83	25.5	12.03	24.5	11.60	23.6	11.11	22.2	10.29
	-7.0	-7.6	28.1	12.63	27.3	12.52	25.5	11.54	24.5	11.05	23.6	10.60	22.2	9.89
	-5.0	-5.6	29.2	11.28	27.2	11.94	25.3	10.78	24.5	10.40	23.6	9.97	22.2	9.27
	-3.0	-3.7	29.2	10.91	27.2	11.24	25.3	10.16	24.5	9.85	23.6	9.41	22.2	8.76
	0.0	-0.7	29.2	11.09	27.2	10.20	25.3	9.26	24.5	8.94	23.6	8.58	22.2	8.00
	3.0	2.2	29.2	10.11	27.2	9.31	25.3	8.47	24.5	8.18	23.6	7.86	22.2	7.33
	5.0	4.1	29.2	9.52	27.2	8.77	25.3	7.99	24.5	7.72	23.6	7.43	22.2	6.93
	7.0	6.0	29.2	8.96	27.2	8.29	25.3	7.55	24.5	7.30	23.6	7.02	22.2	6.56
	9.0	7.9	29.2	8.46	27.2	7.81	25.3	7.18	24.5	6.90	23.6	6.64	22.2	6.22
	11.0	9.8	29.2	7.99	27.2	7.39	25.3	6.76	24.5	6.53	23.6	6.29	22.2	5.90
	13.0	11.8	29.2	7.53	27.2	6.97	25.3	6.40	24.5	6.18	23.6	5.95	22.2	5.58
	15.0	13.7	29.2	7.12	27.2	6.61	25.3	6.07	24.5	5.86	23.6	5.64	22.2	5.31
	18.0	16.8	29.2	6.81	27.2	6.29	25.3	5.78	24.5	5.56	23.6	5.35	22.2	5.06
20.0	18.5	29.2	6.55	27.2	6.03	25.3	5.52	24.5	5.31	23.6	5.10	22.2	4.83	
24.0	20.5	29.2	6.35	27.2	5.83	25.3	5.30	24.5	5.08	23.6	4.87	22.2	4.63	
70%	-19.8	-20.0	25.3	14.01	23.8	13.56	22.3	12.71	21.4	12.40	20.6	12.14	19.5	11.71
	-18.8	-19.0	25.6	14.04	23.9	13.41	22.3	12.62	21.4	12.31	20.6	12.05	19.5	11.46
	-16.7	-17.0	25.6	13.73	23.9	13.12	22.3	12.32	21.4	12.02	20.6	11.72	19.5	10.94
	-13.7	-15.0	25.6	13.42	23.9	12.85	22.3	12.02	21.5	11.63	20.7	11.17	19.5	10.40
	-11.8	-13.0	25.6	13.10	23.9	12.48	22.3	11.47	21.5	11.04	20.7	10.59	19.5	9.86
	-9.8	-11.0	25.7	12.73	24.0	12.02	22.4	10.86	21.5	10.45	20.7	10.03	19.5	9.34
	-9.5	-10.0	25.7	12.53	24.0	11.67	22.4	10.56	21.5	10.16	20.7	9.76	19.5	9.08
	-8.5	-9.1	25.7	12.34	24.0	11.36	22.4	10.28	21.5	9.89	20.7	9.50	19.5	8.85
	-7.0	-7.6	25.6	11.76	23.9	10.83	22.3	9.82	21.5	9.46	20.7	9.08	19.5	8.48
	-5.0	-5.6	25.5	10.99	23.8	10.13	22.2	9.20	21.3	8.85	20.7	8.56	19.5	8.00
	-3.0	-3.7	25.5	10.35	23.8	9.55	22.2	8.69	21.3	8.36	20.7	8.09	19.5	7.57
	0.0	-0.7	25.5	9.42	23.8	8.75	22.2	7.94	21.3	7.65	20.7	7.41	19.5	6.94
	3.0	2.2	25.5	8.60	23.8	7.51	22.2	7.29	21.3	7.02	20.7	6.80	19.5	6.37
	5.0	4.1	25.5	8.12	23.8	7.52	22.2	6.90	21.3	6.64	20.7	6.44	19.5	6.03
	7.0	6.0	25.5	7.68	23.8	7.11	22.2	6.52	21.3	6.29	20.7	6.10	19.5	5.72
	9.0	7.9	25.5	7.26	23.8	6.73	22.2	6.18	21.3	5.96	20.7	5.78	19.5	5.43
	11.0	9.8	25.5	6.86	23.8	6.36	22.2	5.86	21.3	5.66	20.7	5.49	19.5	5.16
	13.0	11.8	25.5	6.48	23.8	6.03	22.2	5.55	21.3	5.36	20.7	5.20	19.5	4.90
	15.0	13.7	25.5	6.14	23.8	5.72	22.2	5.27	21.3	5.10	20.7	4.94	19.5	4.67
	18.0	16.8	25.5	5.83	23.8	5.43	22.2	5.01	21.3	4.85	20.7	4.71	19.5	4.46
20.0	18.5	25.5	5.56	23.8	5.17	22.2	4.79	21.3	4.63	20.7	4.51	19.5	4.28	
24.0	20.5	25.5	5.31	23.8	4.94	22.2	4.60	21.3	4.44	20.7	4.34	19.5	4.12	

TC—Total capacity of outdoor unit; PI—Power input of outdoor unit														
combination	outdoor air temp		indoor air temperature °C DB											
			16		18		20		21		22		24	
	°C DB	°C WB	TC kW	PI kW	TC kW	PI kW	TC kW	PI kW	TC kW	PI kW	TC kW	PI kW	TC kW	PI kW
60%	-19.8	-20.0	21.9	12.93	20.5	12.40	19.1	11.24	18.4	10.81	17.9	10.50	16.7	9.68
	-18.8	-19.0	22.0	12.84	20.6	12.24	19.1	11.02	18.4	10.60	17.9	10.27	16.7	9.47
	-16.7	-17.0	22.0	12.52	20.6	11.75	19.1	10.53	18.4	10.13	17.9	9.81	16.7	9.07
	-13.7	-15.0	22.0	12.12	20.6	11.18	19.1	10.04	18.5	9.67	17.9	9.35	16.7	8.63
	-11.8	-13.0	22.0	11.47	20.6	10.59	19.1	9.53	18.5	9.18	17.9	8.88	16.7	8.21
	-9.8	-11.0	22.1	10.85	20.7	10.03	19.2	9.04	18.5	8.70	17.9	8.41	16.7	7.79
	-9.5	-10.0	22.1	10.55	20.7	9.76	19.2	8.80	18.5	8.48	17.9	8.18	16.7	7.57
	-8.5	-9.1	22.1	10.27	20.7	9.51	19.2	8.58	18.5	8.26	17.9	7.98	16.7	7.39
	-7.0	-7.6	22.0	9.80	20.6	9.08	19.1	8.20	18.5	7.91	17.9	7.65	16.7	7.10
	-5.0	-5.6	21.9	9.18	20.5	8.51	19.0	7.70	18.3	7.42	17.9	7.23	16.7	6.71
	-3.0	-3.7	21.9	8.67	20.5	8.04	19.0	7.32	18.3	7.03	17.9	6.85	16.7	6.35
	0.0	-0.7	21.9	7.92	20.5	7.36	19.0	6.69	18.3	6.46	17.9	6.28	16.7	5.84
	3.0	2.2	21.9	7.26	20.5	6.76	19.0	6.16	18.3	5.94	17.9	5.80	16.7	5.12
	5.0	4.1	21.9	6.87	20.5	6.40	19.0	5.83	18.3	5.64	17.9	5.49	16.7	5.12
	7.0	6.0	21.9	6.50	20.5	6.06	19.0	5.53	18.3	5.35	17.9	5.22	16.7	4.87
	9.0	7.9	21.9	6.16	20.5	5.74	19.0	5.25	18.3	5.08	17.9	4.96	16.7	4.63
	11.0	9.8	21.9	5.84	20.5	5.46	19.0	5.00	18.3	4.83	17.9	4.71	16.7	4.42
	13.0	11.8	21.9	5.53	20.5	5.17	19.0	4.75	18.3	4.59	17.9	4.48	16.7	4.20
	15.0	13.7	21.9	5.26	20.5	4.91	19.0	4.52	18.3	4.37	17.9	4.28	16.7	4.00
	18.0	16.8	21.9	5.03	20.5	4.67	19.0	4.32	18.3	4.18	17.9	4.10	16.7	3.84
20.0	18.5	21.9	4.81	20.5	4.47	19.0	4.14	18.3	4.02	17.9	3.94	16.7	3.70	
24.0	20.5	21.9	4.62	20.5	4.28	19.0	3.99	18.3	3.88	17.9	3.82	16.7	3.57	
50%	-19.8	-20.0	18.3	10.88	17.1	10.03	15.9	9.04	15.3	8.70	14.9	8.47	13.9	7.85
	-18.8	-19.0	18.3	10.66	17.2	9.83	16.0	8.87	15.3	8.52	14.9	8.30	13.9	7.69
	-16.7	-17.0	18.4	10.18	17.2	9.40	16.0	8.49	15.3	8.17	14.9	7.95	13.9	7.38
	-13.7	-15.0	18.4	9.71	17.2	8.97	16.0	8.11	15.3	7.81	14.9	7.59	13.9	7.04
	-11.8	-13.0	18.4	9.22	17.2	8.54	16.0	7.72	15.3	7.43	14.9	7.22	13.9	6.71
	-9.8	-11.0	18.4	8.74	17.2	8.10	16.0	7.35	15.3	7.07	15.0	6.91	13.9	6.38
	-9.5	-10.0	18.4	8.51	17.2	7.88	16.0	7.16	15.4	6.90	15.0	6.73	13.9	6.21
	-8.5	-9.1	18.4	8.30	17.2	7.69	16.0	6.98	15.4	6.73	15.0	6.58	13.9	6.07
	-7.0	-7.6	18.4	7.94	17.2	7.39	16.0	6.69	15.3	6.45	15.0	6.32	13.9	5.84
	-5.0	-5.6	18.3	7.44	17.1	6.92	15.9	6.30	15.2	6.08	15.0	5.98	13.9	5.53
	-3.0	-3.7	18.3	7.05	17.1	6.55	15.9	5.98	15.2	5.76	15.0	5.68	13.9	5.26
	0.0	-0.7	18.3	6.47	17.1	6.02	15.9	5.51	15.2	5.31	15.0	5.24	13.9	4.86
	3.0	2.2	18.3	5.96	17.1	5.55	15.9	5.09	15.2	4.91	15.0	4.85	13.9	4.50
	5.0	4.1	18.3	5.66	17.1	5.26	15.9	4.83	15.2	4.67	15.0	4.61	13.9	4.28
	7.0	6.0	18.3	5.37	17.1	5.00	15.9	4.61	15.2	4.44	15.0	4.39	13.9	4.09
	9.0	7.9	18.3	5.09	17.1	4.76	15.9	4.38	15.2	4.24	15.0	4.18	13.9	3.90
	11.0	9.8	18.3	4.84	17.1	4.52	15.9	4.18	15.2	4.04	15.0	3.99	13.9	3.71
	13.0	11.8	18.3	4.60	17.1	4.30	15.9	3.97	15.2	3.85	15.0	3.79	13.9	3.55
	15.0	13.7	18.3	4.38	17.1	4.10	15.9	3.80	15.2	3.67	15.0	3.63	13.9	3.38
	18.0	16.8	18.3	4.17	17.0	3.90	15.9	3.64	15.2	3.52	15.0	3.47	13.9	3.22
20.0	18.5	18.3	3.97	17.0	3.73	15.9	3.50	15.2	3.39	15.0	3.33	13.9	3.08	
24.0	20.5	18.3	3.78	17.0	3.58	15.9	3.26	15.2	3.28	15.0	3.20	13.9	2.95	

GMV6 HR DC Inverter VRF Units Technical Sales Guide

GMV-VQ335WM/C-X

TC—Total capacity of outdoor unit; PI—Power input of outdoor unit														
combination	outdoor air temp		indoor air temperature °C DB											
			16		18		20		21		22		24	
	°C DB	°C WB	TC kW	PI kW	TC kW	PI kW	TC kW	PI kW	TC kW	PI kW	TC kW	PI kW	TC kW	PI kW
135%	-19.8	-20.0	28.6	9.81	28.5	10.52	28.4	11.10	28.4	11.48	28.4	11.88	28.3	12.59
	-18.8	-19.0	28.9	10.00	28.8	10.70	28.7	11.20	28.7	11.60	28.7	11.96	28.6	12.71
	-16.7	-17.0	29.4	10.26	29.3	10.92	29.3	11.44	29.2	11.70	29.2	12.11	29.1	12.78
	-13.7	-15.0	30.0	10.50	29.9	11.13	29.7	11.56	29.8	11.89	29.7	12.25	29.6	12.86
	-11.8	-13.0	30.4	10.69	30.3	11.23	30.2	11.64	30.3	12.02	30.2	12.31	30.1	12.92
	-9.8	-11.0	30.9	10.85	30.9	11.39	30.8	11.78	30.8	12.08	30.8	12.34	30.7	12.92
	-9.5	-10.0	31.2	10.92	31.2	11.44	31.1	11.80	31.0	12.06	31.1	12.39	30.9	12.85
	-8.5	-9.1	31.5	10.99	31.4	11.48	31.4	11.79	31.3	12.08	31.3	12.36	31.3	12.91
	-7.0	-7.6	31.9	11.06	31.8	11.50	31.7	11.78	31.7	12.05	31.6	12.32	31.6	12.83
	-5.0	-5.6	33.2	11.34	33.1	11.53	32.9	12.04	32.9	12.28	32.8	12.51	32.8	12.97
	-3.0	-3.7	34.7	11.69	34.6	12.12	34.6	12.36	34.5	12.60	34.5	12.83	34.4	13.26
	0.0	-0.7	37.5	12.28	37.5	12.65	37.3	12.86	37.3	13.08	37.2	13.31	37.2	13.71
	3.0	2.2	40.4	12.76	40.3	13.13	40.2	13.32	40.2	13.52	40.2	13.74	40.1	14.11
	5.0	4.1	42.5	13.10	42.3	13.43	42.3	13.60	42.2	13.80	42.2	14.00	42.1	14.35
	7.0	6.0	44.6	13.40	44.5	13.71	44.5	13.88	44.4	12.55	44.4	14.24	42.6	13.71
	9.0	7.9	46.9	13.68	46.7	13.98	46.7	14.12	46.6	14.31	45.7	14.05	42.6	12.89
	11.0	9.8	49.2	13.95	49.1	14.23	48.9	14.26	47.2	13.73	45.7	13.20	42.6	12.14
13.0	11.8	51.9	14.21	51.7	14.49	48.9	13.38	47.2	12.87	45.7	12.39	42.6	11.40	
15.0	13.7	54.4	14.46	52.0	13.72	48.9	12.61	47.2	12.14	45.7	11.68	42.6	10.76	
18.0	16.8	54.4	13.69	52.0	13.06	48.9	11.96	47.2	11.54	45.7	11.04	42.6	10.22	
20.0	18.5	54.4	13.03	52.0	12.48	48.9	11.41	47.2	11.02	45.7	10.49	42.6	9.76	
24.0	20.5	54.4	12.46	52.0	12.00	48.9	10.98	47.2	10.60	45.7	10.02	42.6	9.41	
120%	-19.8	-20.0	28.5	10.78	28.4	11.43	28.4	11.96	28.4	12.29	28.3	12.61	28.2	13.33
	-18.8	-19.0	28.8	10.94	28.7	11.60	28.7	11.89	28.6	12.38	28.6	12.75	28.6	13.45
	-16.7	-17.0	29.3	11.15	29.3	11.77	29.2	12.15	29.1	12.50	29.2	12.85	29.1	13.50
	-13.7	-15.0	29.8	11.30	29.7	11.87	29.7	12.27	29.7	12.61	29.6	12.89	29.6	13.50
	-11.8	-13.0	30.3	11.46	30.2	11.96	30.2	12.32	30.2	12.63	30.1	12.95	30.1	13.47
	-9.8	-11.0	30.9	11.58	30.8	12.07	30.7	12.35	30.8	12.70	30.7	12.93	30.6	13.50
	-9.5	-10.0	31.2	11.62	31.1	12.10	31.0	12.40	31.0	12.65	31.0	12.82	30.9	13.45
	-8.5	-9.1	31.4	11.66	31.4	12.12	31.3	12.37	31.2	12.64	31.3	12.93	31.2	13.44
	-7.0	-7.6	31.7	11.67	31.7	12.06	31.6	12.32	31.6	12.58	31.6	12.84	31.5	13.27
	-5.0	-5.6	33.1	11.91	32.9	12.30	32.8	12.53	32.8	12.76	32.8	13.00	32.7	13.41
	-3.0	-3.7	34.6	12.26	34.6	12.64	34.5	12.84	34.5	13.05	34.4	13.29	34.4	13.69
	0.0	-0.7	37.3	12.78	37.3	13.13	37.2	13.46	37.2	13.51	37.1	13.72	37.1	14.10
	3.0	2.2	40.3	13.25	40.2	13.57	40.2	13.73	40.1	13.93	40.1	14.12	39.3	14.08
	5.0	4.1	42.3	13.54	42.2	13.85	42.2	13.99	42.1	14.17	42.1	14.36	39.3	13.22
	7.0	6.0	44.5	13.82	44.5	14.11	44.4	14.24	43.7	14.07	42.2	13.53	39.3	12.45
	9.0	7.9	46.7	14.09	46.6	14.37	45.1	13.74	43.7	13.23	42.2	12.72	39.3	11.71
	11.0	9.8	49.1	14.34	48.1	14.14	45.1	12.93	43.7	12.46	42.2	11.98	39.3	11.04
13.0	11.8	50.9	14.20	48.1	13.26	45.1	12.13	43.7	11.70	42.2	11.27	39.3	10.39	
15.0	13.7	50.9	13.37	48.1	12.49	45.1	11.45	43.7	11.03	42.2	10.63	39.3	9.81	
18.0	16.8	50.9	12.63	48.1	11.83	45.1	10.88	43.7	10.46	42.2	10.07	39.3	9.30	
20.0	18.5	50.9	11.97	48.1	11.29	45.1	10.41	43.7	9.97	42.2	9.59	39.3	8.86	
24.0	20.5	50.9	11.39	48.1	10.82	45.1	10.03	43.7	9.56	42.2	9.21	39.3	8.49	

TC—Total capacity of outdoor unit; PI—Power input of outdoor unit														
combination	outdoor air temp		indoor air temperature °C DB											
			16		18		20		21		22		24	
	°C DB	°C WB	TC kW	PI kW	TC kW	PI kW	TC kW	PI kW	TC kW	PI kW	TC kW	PI kW	TC kW	PI kW
110%	-19.8	-20.0	28.4	11.74	28.3	12.35	28.3	12.77	28.3	13.11	28.2	13.41	28.2	14.08
	-18.8	-19.0	28.7	11.87	28.7	12.43	28.6	12.83	28.5	13.12	28.6	13.53	28.5	14.11
	-16.7	-17.0	29.2	12.00	29.1	12.57	29.0	12.88	29.1	13.26	29.1	13.60	29.0	14.20
	-13.7	-15.0	29.7	12.13	29.7	12.67	29.6	13.00	29.6	13.31	29.6	13.57	29.6	14.19
	-11.8	-13.0	30.2	12.26	30.2	12.70	30.1	13.00	30.1	13.28	30.1	13.58	30.0	14.08
	-9.8	-11.0	30.8	12.30	30.7	12.76	30.7	12.98	30.7	13.31	30.6	13.54	30.6	13.99
	-9.5	-10.0	31.0	12.28	30.9	12.71	30.9	12.98	30.9	13.24	30.9	13.50	30.9	13.98
	-8.5	-9.1	31.3	12.30	31.3	12.77	31.2	12.96	31.2	13.18	31.2	13.49	31.1	13.89
	-7.0	-7.6	31.7	12.31	31.6	12.65	31.5	12.87	31.6	13.12	31.5	13.17	31.4	13.76
	-5.0	-5.6	32.9	12.49	32.8	12.85	32.7	13.02	32.7	13.24	34.3	13.47	32.6	13.87
	-3.0	-3.7	34.5	12.81	34.5	13.15	34.4	13.31	34.4	13.52	37.1	13.73	34.3	14.12
	0.0	-0.7	37.2	13.28	37.2	13.60	37.1	13.74	37.1	13.93	38.7	14.14	36.0	13.90
	3.0	2.2	40.2	13.73	40.1	14.02	40.1	14.13	40.0	14.30	38.7	13.76	36.0	12.66
	5.0	4.1	42.2	13.99	42.2	14.28	41.4	13.97	40.0	13.44	38.7	12.95	36.0	11.91
	7.0	6.0	44.4	14.25	44.0	14.34	41.4	13.13	40.0	12.65	38.7	12.17	36.0	11.21
	9.0	7.9	47.2	14.65	44.0	13.48	41.4	12.36	40.0	11.91	38.7	11.46	36.0	10.57
	11.0	9.8	47.7	13.93	44.0	12.68	41.4	11.64	40.0	11.23	38.7	10.81	36.0	9.97
	13.0	11.8	47.7	13.07	44.5	12.03	41.4	10.95	40.0	10.56	38.7	10.17	36.0	9.39
15.0	13.7	47.7	12.31	44.5	11.34	41.4	10.35	40.0	9.97	38.7	9.62	36.0	8.89	
18.0	16.8	47.7	11.65	44.5	10.75	41.4	9.44	40.0	9.45	38.7	9.17	36.0	8.46	
20.0	18.5	47.7	11.05	44.5	10.23	41.4	8.95	40.0	9.00	38.7	8.78	36.0	8.10	
24.0	20.5	47.7	10.55	44.5	9.76	41.4	8.53	40.0	8.62	38.7	8.46	36.0	7.79	
100%	-19.8	-20.0	28.4	12.74	28.2	13.22	28.1	13.48	28.1	13.87	28.0	14.11	27.9	14.73
	-18.8	-19.0	28.5	12.76	28.4	13.23	28.4	13.58	28.3	13.86	28.3	14.21	28.2	14.74
	-16.7	-17.0	29.0	12.86	28.9	13.36	28.8	13.58	28.8	13.88	28.8	14.20	28.7	14.70
	-13.7	-15.0	29.6	12.93	29.5	13.41	29.4	13.60	29.4	13.96	29.2	14.11	29.2	14.70
	-11.8	-13.0	30.1	13.01	30.0	13.38	29.9	13.61	29.9	13.88	29.7	13.54	29.6	14.53
	-9.8	-11.0	30.6	12.99	30.5	13.40	30.4	13.53	30.5	13.80	30.2	13.96	30.1	14.36
	-9.5	-10.0	30.8	12.94	30.7	13.33	30.6	13.46	30.7	13.76	30.5	13.90	30.4	14.35
	-8.5	-9.1	31.0	12.91	30.9	13.24	30.9	13.45	30.9	13.65	30.7	13.84	30.6	14.21
	-7.0	-7.6	31.4	12.85	31.3	13.16	31.2	13.30	31.2	13.54	31.0	13.64	31.0	14.10
	-5.0	-5.6	32.8	13.07	32.7	13.39	32.7	13.53	32.6	13.74	32.6	13.93	32.6	14.31
	-3.0	-3.7	34.4	13.36	34.4	13.67	34.3	13.79	34.3	13.98	34.3	14.18	32.8	13.63
	0.0	-0.7	37.1	13.81	37.1	14.08	37.0	14.18	36.4	13.99	35.2	13.45	32.8	12.40
	3.0	2.2	40.1	14.19	40.0	14.45	37.6	13.21	36.4	12.73	35.2	12.26	32.8	11.28
	5.0	4.1	42.1	14.45	40.0	13.57	37.6	12.43	36.4	11.99	35.2	11.55	32.8	10.64
	7.0	6.0	42.3	13.71	40.0	12.76	37.5	11.44	36.4	11.29	35.2	10.88	32.8	10.03
	9.0	7.9	42.3	12.88	40.5	12.17	37.6	10.96	36.4	10.64	35.2	10.26	32.8	9.47
	11.0	9.8	43.4	12.43	40.5	11.47	37.6	10.35	36.4	10.04	35.2	9.68	32.8	8.95
	13.0	11.8	43.4	11.68	40.5	10.78	37.6	9.75	36.4	9.46	35.2	9.13	32.8	8.45
15.0	13.7	43.4	11.01	40.5	10.17	37.6	9.22	36.4	8.95	35.2	8.63	32.8	8.00	
18.0	16.8	43.4	10.38	40.5	9.71	37.6	8.92	36.4	8.49	35.2	8.17	32.8	7.62	
20.0	18.5	43.4	9.80	40.5	9.32	37.6	8.56	36.4	8.11	35.2	7.79	32.8	7.32	
24.0	20.5	43.4	9.27	40.5	9.01	37.6	8.23	36.4	7.81	35.2	7.49	32.8	7.09	

GMV6 HR DC Inverter VRF Units Technical Sales Guide

TC—Total capacity of outdoor unit; PI—Power input of outdoor unit														
combination	outdoor air temp		indoor air temperature °C DB											
			16		18		20		21		22		24	
	°C DB	°C WB	TC kW	PI kW	TC kW	PI kW	TC kW	PI kW	TC kW	PI kW	TC kW	PI kW	TC kW	PI kW
90%	-19.8	-20.0	28.2	13.65	28.1	14.15	28.0	14.34	28.1	14.73	28.0	15.00	28.0	15.51
	-18.8	-19.0	28.4	13.71	28.3	14.15	28.3	14.39	28.3	14.70	28.4	15.00	28.2	15.53
	-16.7	-17.0	28.9	13.77	28.9	14.24	28.8	14.38	28.9	14.69	28.9	15.04	28.8	15.47
	-13.7	-15.0	29.5	13.79	29.4	14.23	29.4	14.36	29.4	14.57	29.3	14.93	28.9	15.17
	-11.8	-13.0	30.0	13.79	29.9	14.14	29.9	14.31	29.9	14.59	29.9	14.79	28.9	14.81
	-9.8	-11.0	30.5	13.67	30.5	14.04	30.4	14.19	30.5	14.46	30.4	14.65	29.0	14.40
	-9.5	-10.0	30.8	13.64	30.7	14.01	30.6	14.08	30.7	14.39	30.7	14.63	29.1	14.24
	-8.5	-9.1	31.0	13.60	30.9	13.89	30.8	14.02	30.9	14.25	30.9	14.49	29.5	14.17
	-7.0	-7.6	31.3	13.49	31.2	13.76	31.2	13.89	31.2	14.11	31.2	14.28	29.5	13.53
	-5.0	-5.6	32.7	13.66	32.6	13.95	32.6	14.02	32.6	14.22	31.6	13.82	29.5	12.73
	-3.0	-3.7	34.3	13.92	34.3	12.65	33.9	14.04	32.7	13.53	31.6	13.02	29.5	12.00
	0.0	-0.7	37.1	14.31	36.0	12.42	33.9	12.76	32.7	12.30	31.6	11.84	29.5	10.92
	3.0	2.2	38.2	13.64	36.0	12.70	33.9	11.64	32.7	11.23	31.6	10.81	29.5	9.99
	5.0	4.1	38.2	12.82	36.4	12.07	33.9	10.98	32.7	10.58	31.6	10.21	29.5	9.42
	7.0	6.0	39.0	12.31	36.4	11.37	33.9	10.34	32.7	9.99	31.6	9.63	29.5	8.90
	9.0	7.9	39.0	11.61	36.4	10.70	33.9	9.76	32.7	9.43	31.6	9.10	29.5	8.42
	11.0	9.8	39.0	10.93	36.4	10.09	33.9	9.23	32.7	8.91	31.6	8.60	29.5	7.97
	13.0	11.8	39.0	10.29	36.4	9.52	33.9	8.70	32.7	8.41	31.6	8.13	29.5	7.53
	15.0	13.7	39.0	9.72	36.4	8.99	33.9	8.25	32.7	7.94	31.6	7.70	29.5	7.15
	18.0	16.8	39.0	9.19	36.4	8.50	33.9	7.83	32.7	7.50	31.6	7.30	29.5	6.80
20.0	18.5	39.0	8.69	36.4	8.03	33.9	7.43	32.7	7.08	31.6	6.94	29.5	6.49	
24.0	20.5	39.0	8.20	36.4	7.58	33.9	7.05	32.7	6.68	31.6	6.59	29.5	6.20	
80%	-19.8	-20.0	28.0	14.58	28.0	15.08	28.0	15.18	28.0	15.49	27.9	15.80	25.6	14.93
	-18.8	-19.0	28.3	14.66	28.3	15.05	28.2	15.20	28.3	15.51	28.0	15.61	25.7	14.84
	-16.7	-17.0	28.9	14.67	28.8	15.08	28.7	15.17	28.8	15.45	28.0	15.27	25.7	14.47
	-13.7	-15.0	29.3	14.58	29.4	15.02	29.3	15.09	29.1	15.24	28.1	14.97	25.9	14.22
	-11.8	-13.0	29.8	14.53	29.9	14.90	29.8	14.99	29.1	14.88	28.1	14.55	26.3	13.74
	-9.8	-11.0	30.4	14.40	30.3	14.69	30.3	14.83	29.2	14.46	28.1	14.06	26.3	12.98
	-9.5	-10.0	30.7	14.34	30.6	14.67	30.4	14.59	29.2	14.23	28.1	13.66	26.3	12.60
	-8.5	-9.1	30.9	14.27	30.8	14.54	30.4	14.41	29.2	13.89	28.1	13.30	26.3	12.27
	-7.0	-7.6	31.1	14.08	31.2	14.37	30.3	13.82	29.1	13.23	28.2	12.74	26.3	11.78
	-5.0	-5.6	32.6	12.69	32.0	14.15	30.1	12.91	29.1	12.45	28.2	11.99	26.3	11.05
	-3.0	-3.7	33.9	12.77	32.3	13.44	30.1	12.16	29.1	11.79	28.2	11.31	26.3	10.44
	0.0	-0.7	33.9	12.98	32.3	12.20	30.1	11.08	29.1	10.70	28.2	10.31	26.3	9.53
	3.0	2.2	34.7	12.11	32.3	11.13	30.1	10.14	29.1	9.78	28.2	9.44	26.3	8.74
	5.0	4.1	34.7	11.40	32.3	10.50	30.1	9.57	29.1	9.24	28.2	8.93	26.3	8.26
	7.0	6.0	34.7	10.74	32.3	9.92	30.1	9.04	29.1	8.74	28.2	8.44	26.3	7.82
	9.0	7.9	34.7	10.14	32.3	9.35	30.1	8.59	29.1	8.26	28.2	7.99	26.3	7.41
	11.0	9.8	34.7	9.57	32.3	8.84	30.1	8.09	29.1	7.82	28.2	7.56	26.3	7.03
	13.0	11.8	34.7	9.02	32.3	8.34	30.1	7.65	29.1	7.39	28.2	7.15	26.3	6.64
	15.0	13.7	34.7	8.54	32.3	7.91	30.1	7.26	29.1	7.02	28.2	6.78	26.3	6.32
	18.0	16.8	34.7	8.14	32.3	7.52	30.1	6.91	29.1	6.67	28.2	6.43	26.3	6.03
20.0	18.5	34.7	7.83	32.3	7.21	30.1	6.61	29.1	6.36	28.2	6.13	26.3	5.76	
24.0	20.5	34.7	7.59	32.3	6.97	30.1	6.34	29.1	6.09	28.2	5.85	26.3	5.51	

TC—Total capacity of outdoor unit; PI—Power input of outdoor unit														
combination	outdoor air temp		indoor air temperature °C DB											
			16		18		20		21		22		24	
	°C DB	°C WB	TC kW	PI kW	TC kW	PI kW	TC kW	PI kW	TC kW	PI kW	TC kW	PI kW	TC kW	PI kW
70%	-19.8	-20.0	27.9	15.56	27.9	15.96	26.5	15.21	25.4	14.83	24.4	14.49	22.9	13.87
	-18.8	-19.0	28.2	15.58	28.2	15.95	26.5	15.10	25.5	14.72	24.5	14.38	22.9	13.58
	-16.7	-17.0	28.7	15.51	28.5	15.77	26.5	14.75	25.5	14.38	24.6	14.07	22.9	12.96
	-13.7	-15.0	29.3	15.42	28.6	15.45	26.6	14.39	25.5	13.92	24.6	13.38	22.9	12.32
	-11.8	-13.0	29.8	15.32	28.6	15.00	26.6	13.74	25.5	13.20	24.6	12.68	22.9	11.68
	-9.8	-11.0	30.3	15.13	28.6	14.45	26.6	13.01	25.6	12.50	24.6	11.99	22.9	11.06
	-9.5	-10.0	30.5	14.99	28.6	14.03	26.6	12.64	25.6	12.15	24.6	11.66	22.9	10.76
	-8.5	-9.1	30.6	14.82	28.6	13.66	26.6	12.31	25.6	11.83	24.6	11.36	22.9	10.48
	-7.0	-7.6	30.6	14.13	28.6	13.02	26.6	11.76	25.5	11.31	24.6	10.88	22.9	10.04
	-5.0	-5.6	30.4	13.19	28.4	12.18	26.4	11.02	25.4	10.59	24.6	10.24	22.9	9.48
	-3.0	-3.7	30.4	12.42	28.4	11.48	26.4	10.41	25.4	10.00	24.6	9.68	22.9	8.96
	0.0	-0.7	30.4	11.31	28.4	10.51	26.4	9.51	25.4	9.15	24.6	8.86	22.9	8.22
	3.0	2.2	30.4	10.33	28.4	9.72	26.4	8.73	25.4	8.40	24.6	8.13	22.9	7.54
	5.0	4.1	30.4	9.75	28.4	9.04	26.4	8.26	25.4	7.94	24.6	7.71	22.9	7.15
	7.0	6.0	30.4	9.22	28.4	8.55	26.4	7.81	25.4	7.52	24.6	7.30	22.9	6.78
	9.0	7.9	30.4	8.71	28.4	8.09	26.4	7.40	25.4	7.13	24.6	6.92	22.9	6.43
	11.0	9.8	30.4	8.24	28.4	7.65	26.4	7.02	25.4	6.77	24.6	6.57	22.9	6.11
	13.0	11.8	30.4	7.79	28.4	7.24	26.4	6.64	25.4	6.42	24.6	6.22	22.9	5.80
	15.0	13.7	30.4	7.38	28.4	6.87	26.4	6.31	25.4	6.10	24.6	5.91	22.9	5.53
	18.0	16.8	30.4	7.00	28.4	6.53	26.4	6.00	25.4	5.82	24.6	5.64	22.9	5.28
20.0	18.5	30.4	6.67	28.4	6.21	26.4	5.73	25.4	5.56	24.6	5.40	22.9	5.07	
24.0	20.5	30.4	6.37	28.4	5.93	26.4	5.50	25.4	5.33	24.6	5.20	22.9	4.88	
60%	-19.8	-20.0	26.2	15.53	24.4	14.81	22.7	13.46	21.8	12.91	21.2	12.49	19.7	11.51
	-18.8	-19.0	26.2	15.41	24.4	14.62	22.7	13.20	21.8	12.65	21.2	12.22	19.7	11.27
	-16.7	-17.0	26.2	15.03	24.4	14.03	22.7	12.61	21.9	12.10	21.2	11.68	19.7	10.78
	-13.7	-15.0	26.3	14.55	24.5	13.35	22.8	12.03	21.9	11.54	21.2	11.12	19.7	10.27
	-11.8	-13.0	26.3	13.77	24.5	12.65	22.8	11.42	21.9	10.96	21.2	10.56	19.7	9.77
	-9.8	-11.0	26.3	13.03	24.5	11.98	22.8	10.83	21.9	10.39	21.2	10.01	19.7	9.26
	-9.5	-10.0	26.3	12.67	24.5	11.66	22.8	10.54	21.9	10.12	21.2	9.73	19.7	9.01
	-8.5	-9.1	26.3	12.33	24.5	11.36	22.8	10.28	21.9	9.87	21.2	9.49	19.7	8.79
	-7.0	-7.6	26.3	11.77	24.5	10.85	22.8	9.83	21.9	9.44	21.2	9.10	19.7	8.44
	-5.0	-5.6	26.1	11.02	24.3	10.16	22.6	9.23	21.9	8.91	21.2	8.60	19.7	7.99
	-3.0	-3.7	26.1	10.41	24.3	9.60	22.6	8.77	21.9	8.44	21.2	8.15	19.7	7.56
	0.0	-0.7	26.1	9.51	24.3	8.79	22.6	8.01	21.9	7.75	21.2	7.48	19.7	6.95
	3.0	2.2	26.1	8.72	24.3	8.08	22.6	7.38	21.9	7.13	21.2	6.90	19.7	6.41
	5.0	4.1	26.1	8.24	24.3	7.64	22.6	6.99	21.9	6.76	21.2	6.54	19.7	6.09
	7.0	6.0	26.1	7.80	24.3	7.23	22.6	6.63	21.9	6.42	21.2	6.22	19.7	5.79
	9.0	7.9	26.1	7.39	24.3	6.86	22.6	6.30	21.9	6.10	21.2	5.90	19.7	5.51
	11.0	9.8	26.1	7.01	24.3	6.52	22.6	5.99	21.9	5.80	21.2	5.61	19.7	5.25
	13.0	11.8	26.1	6.63	24.3	6.17	22.6	5.69	21.9	5.51	21.2	5.33	19.7	4.99
	15.0	13.7	26.1	6.32	24.3	5.86	22.6	5.42	21.9	5.25	21.2	5.09	19.7	4.76
	18.0	16.8	26.1	6.03	24.3	5.58	22.6	5.17	21.9	5.02	21.2	4.88	19.7	4.56
20.0	18.5	26.1	5.78	24.3	5.33	22.6	4.95	21.9	4.82	21.2	4.69	19.7	4.40	
24.0	20.5	26.1	5.56	24.3	5.11	22.6	4.77	21.9	4.66	21.2	4.54	19.7	4.24	

GMV6 HR DC Inverter VRF Units Technical Sales Guide

TC—Total capacity of outdoor unit; PI—Power input of outdoor unit														
combination	outdoor air temp		indoor air temperature °C DB											
			16		18		20		21		22		24	
	°C DB	°C WB	TC kW	PI kW	TC kW	PI kW	TC kW	PI kW	TC kW	PI kW	TC kW	PI kW	TC kW	PI kW
50%	-19.8	-20.0	21.8	13.00	20.4	12.00	19.0	10.82	18.2	10.44	17.6	10.07	16.4	9.32
	-18.8	-19.0	21.8	12.73	20.4	11.76	19.0	10.62	18.2	10.22	17.6	9.86	16.4	9.14
	-16.7	-17.0	21.8	12.16	20.4	11.24	19.0	10.17	18.2	9.80	17.6	9.45	16.4	8.76
	-13.7	-15.0	21.8	11.60	20.4	10.73	19.0	9.71	18.3	9.37	17.6	9.01	16.4	8.36
	-11.8	-13.0	21.8	11.02	20.4	10.22	19.0	9.25	18.3	8.92	17.6	8.58	16.4	7.97
	-9.8	-11.0	21.9	10.45	20.5	9.68	19.1	8.79	18.3	8.48	17.6	8.15	16.4	7.57
	-9.5	-10.0	21.9	10.17	20.5	9.42	19.1	8.57	18.3	8.27	17.6	7.94	16.4	7.38
	-8.5	-9.1	21.9	9.91	20.5	9.20	19.1	8.36	18.3	8.08	17.6	7.76	16.4	7.21
	-7.0	-7.6	21.8	9.48	20.4	8.84	19.0	8.02	18.3	7.74	17.6	7.46	16.4	6.93
	-5.0	-5.6	21.7	8.89	20.3	8.27	18.9	7.55	18.2	7.29	17.6	7.06	16.4	6.57
	-3.0	-3.7	21.7	8.42	20.3	7.84	18.9	7.16	18.2	6.91	17.6	6.70	16.4	6.25
	0.0	-0.7	21.7	7.73	20.3	7.20	18.9	6.60	18.2	6.37	17.6	6.18	16.4	5.77
	3.0	2.2	21.7	7.12	20.3	6.64	18.9	6.09	18.2	5.89	17.6	5.73	16.4	5.35
	5.0	4.1	21.7	6.76	20.3	6.30	18.9	5.79	18.2	5.60	17.6	5.44	16.4	5.09
	7.0	6.0	21.7	6.41	20.3	5.98	18.9	5.52	18.2	5.33	17.6	5.18	16.4	4.86
	9.0	7.9	21.7	6.08	20.3	5.69	18.9	5.24	18.2	5.09	17.6	4.94	16.4	4.63
	11.0	9.8	21.7	5.78	20.3	5.41	18.9	5.00	18.2	4.84	17.6	4.71	16.4	4.41
13.0	11.8	21.7	5.50	20.3	5.14	18.9	4.76	18.2	4.62	17.6	4.48	16.4	4.21	
15.0	13.7	21.7	5.23	20.3	4.91	18.9	4.55	18.2	4.40	17.6	4.28	16.4	4.01	
18.0	16.8	21.7	4.98	20.3	4.69	18.9	4.36	18.2	4.23	17.6	4.10	16.4	3.83	
20.0	18.5	21.7	4.75	20.3	4.48	18.9	4.19	18.2	4.08	17.6	3.93	16.4	3.66	
24.0	20.5	21.7	4.53	20.3	4.30	18.9	3.90	18.2	3.94	17.6	3.78	16.4	3.51	

GMV-VQ400WM/C-X

TC—Total capacity of outdoor unit; PI—Power input of outdoor unit														
combination	outdoor air temp		indoor air temperature °C DB											
			16		18		20		21		22		24	
	°C DB	°C WB	TC kW	PI kW	TC kW	PI kW	TC kW	PI kW	TC kW	PI kW	TC kW	PI kW	TC kW	PI kW
135%	-19.8	-20.0	37.4	12.16	37.2	13.02	37.1	13.74	37.2	14.21	37.1	14.72	37.1	15.61
	-18.8	-19.0	37.7	12.36	37.7	13.25	37.5	13.83	37.5	14.37	37.5	14.78	37.4	15.72
	-16.7	-17.0	38.4	12.67	38.3	13.49	38.1	14.10	38.2	14.48	38.1	14.95	38.0	15.84
	-13.7	-15.0	39.0	12.95	39.0	13.73	38.8	14.28	38.8	14.69	38.8	15.16	38.7	15.92
	-11.8	-13.0	39.6	13.21	39.6	13.89	39.4	14.37	39.5	14.83	39.4	15.20	39.3	15.97
	-9.8	-11.0	40.3	13.39	40.3	14.07	40.1	14.51	40.1	14.89	40.1	15.23	40.0	15.95
	-9.5	-10.0	40.6	13.45	40.6	14.09	40.4	14.51	40.4	14.87	40.4	15.25	40.3	15.88
	-8.5	-9.1	41.0	13.54	40.8	14.13	40.8	14.51	40.7	14.88	40.8	15.23	40.7	15.91
	-7.0	-7.6	41.4	13.59	41.3	14.14	41.3	14.53	41.2	14.83	41.2	15.17	41.1	15.83
	-5.0	-5.6	44.0	14.24	44.0	14.53	43.9	15.19	43.8	15.48	43.9	15.84	43.7	16.37
	-3.0	-3.7	44.6	14.25	44.6	14.78	44.5	15.05	44.5	15.38	44.4	15.64	44.3	16.20
	0.0	-0.7	45.6	14.15	45.6	14.58	45.5	14.84	45.5	15.07	45.4	15.37	45.3	15.81
	3.0	2.2	48.5	14.52	48.4	14.92	48.2	15.14	48.2	15.36	48.2	15.61	48.1	16.03
	5.0	4.1	51.0	14.89	50.8	15.27	50.8	15.45	50.7	15.68	50.7	15.91	50.5	16.31
	7.0	6.0	53.5	15.23	53.4	15.58	53.4	15.77	53.2	14.26	53.2	16.19	51.1	15.58
	9.0	7.9	56.2	15.55	56.1	15.89	56.1	16.05	56.0	16.26	54.8	15.96	51.1	14.65
	11.0	9.8	59.1	15.86	59.0	16.17	58.7	16.21	56.7	15.60	54.8	15.00	51.1	13.80
13.0	11.8	62.2	16.16	62.1	16.47	58.7	15.20	56.7	14.63	54.8	14.09	51.1	12.95	
15.0	13.7	65.2	16.44	62.4	15.59	58.7	14.33	56.7	13.80	54.8	13.27	51.1	12.22	
18.0	16.8	65.2	15.56	62.4	14.84	58.7	13.59	56.7	13.11	54.8	12.55	51.1	11.62	
20.0	18.5	65.2	14.81	62.4	14.18	58.7	12.97	56.7	12.53	54.8	11.93	51.1	11.10	
24.0	20.5	65.2	14.17	62.4	13.64	58.7	12.47	56.7	12.04	54.8	11.39	51.1	10.70	

TC—Total capacity of outdoor unit; PI—Power input of outdoor unit														
combination	outdoor air temp		indoor air temperature °C DB											
			16		18		20		21		22		24	
	°C DB	°C WB	TC kW	PI kW	TC kW	PI kW	TC kW	PI kW	TC kW	PI kW	TC kW	PI kW	TC kW	PI kW
120%	-19.8	-20.0	37.2	13.33	37.1	14.16	37.1	14.78	37.0	15.18	37.1	15.64	37.0	16.55
	-18.8	-19.0	37.5	13.50	37.5	14.32	37.4	14.70	37.4	15.31	37.4	15.77	37.3	16.65
	-16.7	-17.0	38.2	13.74	38.1	14.52	38.1	14.99	38.0	15.44	38.0	15.88	38.0	16.69
	-13.7	-15.0	38.9	13.96	38.8	14.67	38.7	15.17	38.8	15.59	38.7	15.95	38.7	16.73
	-11.8	-13.0	39.5	14.14	39.4	14.76	39.4	15.21	39.4	15.60	39.3	16.00	39.3	16.67
	-9.8	-11.0	40.2	14.26	40.1	14.88	40.0	15.23	40.1	15.66	40.0	15.96	40.0	16.68
	-9.5	-10.0	40.5	14.28	40.4	14.89	40.3	15.26	40.4	15.61	40.3	15.79	40.3	16.57
	-8.5	-9.1	40.8	14.35	40.8	14.93	40.7	15.23	40.7	15.59	40.7	15.94	40.6	16.58
	-7.0	-7.6	41.3	14.39	41.2	14.85	41.1	15.18	41.2	15.50	41.1	15.83	41.0	16.37
	-5.0	-5.6	44.0	14.99	43.9	15.53	43.8	15.85	43.8	16.12	43.8	16.43	43.7	16.96
	-3.0	-3.7	44.6	14.95	44.5	15.40	44.4	15.63	44.4	15.91	44.3	16.23	44.3	16.70
	0.0	-0.7	45.6	14.77	45.5	15.15	45.4	15.53	45.4	15.60	45.3	15.87	45.3	16.30
	3.0	2.2	48.4	15.06	48.2	15.42	48.2	15.59	48.1	15.82	48.1	16.04	47.1	16.00
	5.0	4.1	50.8	15.39	50.7	15.74	50.7	15.89	50.5	16.10	50.5	16.32	47.1	15.03
	7.0	6.0	53.4	15.71	53.4	16.03	53.2	16.17	52.4	15.99	50.7	15.37	47.1	14.14
	9.0	7.9	56.1	16.02	56.0	16.33	54.1	15.61	52.4	15.03	50.7	14.46	47.1	13.31
	11.0	9.8	59.0	16.30	57.5	16.02	54.1	14.69	52.4	14.15	50.7	13.61	47.1	12.55
	13.0	11.8	61.1	16.14	57.5	15.02	54.1	13.79	52.4	13.30	50.7	12.80	47.1	11.81
	15.0	13.7	61.1	15.20	57.5	14.15	54.1	13.01	52.4	12.54	50.7	12.08	47.1	11.15
	18.0	16.8	61.1	14.36	57.5	13.40	54.1	12.36	52.4	11.88	50.7	11.44	47.1	10.57
20.0	18.5	61.1	13.61	57.5	12.79	54.1	11.83	52.4	11.33	50.7	10.90	47.1	10.07	
24.0	20.5	61.1	12.94	57.5	12.26	54.1	11.40	52.4	10.87	50.7	10.47	47.1	9.65	
110%	-19.8	-20.0	37.1	14.54	37.1	15.31	37.0	15.84	37.0	16.21	37.0	16.64	36.9	17.49
	-18.8	-19.0	37.5	14.68	37.4	15.37	37.4	15.87	37.3	16.24	37.3	16.75	37.3	17.49
	-16.7	-17.0	38.1	14.86	38.1	15.57	38.0	15.96	37.9	16.39	38.0	16.81	37.9	17.57
	-13.7	-15.0	38.8	15.00	38.7	15.68	38.7	16.08	38.6	16.43	38.7	16.81	38.6	17.54
	-11.8	-13.0	39.4	15.14	39.4	15.69	39.3	16.06	39.2	16.37	39.3	16.80	39.2	17.43
	-9.8	-11.0	40.1	15.17	40.0	15.75	40.0	16.02	39.9	16.39	40.0	16.72	39.9	17.29
	-9.5	-10.0	40.4	15.15	40.3	15.70	40.3	16.03	40.2	16.31	40.3	16.64	40.2	17.25
	-8.5	-9.1	40.8	15.19	40.7	15.73	40.7	15.98	40.6	16.25	40.6	16.64	40.6	17.16
	-7.0	-7.6	41.2	15.16	41.1	15.59	41.1	15.87	41.1	16.18	41.0	16.25	41.0	17.00
	-5.0	-5.6	43.9	15.77	43.8	16.26	43.7	16.47	43.7	16.76	43.7	16.26	42.7	17.21
	-3.0	-3.7	44.4	15.62	44.4	16.01	44.3	16.24	44.3	16.51	44.5	15.60	41.1	16.04
	0.0	-0.7	45.4	15.35	45.4	15.70	45.3	15.88	45.3	16.12	46.4	16.07	43.2	15.80
	3.0	2.2	48.2	15.60	48.1	15.93	48.1	16.05	48.0	16.25	46.4	15.64	43.2	14.38
	5.0	4.1	50.7	15.90	50.7	16.23	49.7	15.87	48.0	15.28	46.4	14.71	43.2	13.53
	7.0	6.0	53.2	16.19	52.8	16.30	49.7	14.92	48.0	14.37	46.4	13.83	43.2	12.74
	9.0	7.9	56.0	16.46	52.8	15.32	49.7	14.05	48.0	13.53	46.4	13.02	43.2	12.01
	11.0	9.8	56.0	15.48	52.8	14.41	49.7	13.23	48.0	12.76	46.4	12.28	43.2	11.33
	13.0	11.8	56.0	14.52	52.8	13.52	49.7	12.44	48.0	12.00	46.4	11.56	43.2	10.68
	15.0	13.7	56.0	13.68	52.8	12.75	49.7	11.75	48.0	11.33	46.4	10.93	43.2	10.10
	18.0	16.8	56.0	12.95	52.8	12.09	49.7	10.73	48.0	10.74	46.4	10.42	43.2	9.62
20.0	18.5	56.0	12.28	52.8	11.50	49.7	10.18	48.0	10.23	46.4	9.98	43.2	9.20	
24.0	20.5	56.0	11.72	52.8	10.97	49.7	9.69	48.0	9.79	46.4	9.62	43.2	8.85	

GMV6 HR DC Inverter VRF Units Technical Sales Guide

TC—Total capacity of outdoor unit; PI—Power input of outdoor unit														
combination	outdoor air temp		indoor air temperature °C DB											
			16		18		20		21		22		24	
	TC	PI	TC	PI	TC	PI	TC	PI	TC	PI	TC	PI	TC	PI
	°C DB	°C WB	kW	kW	kW	kW	kW	kW	kW	kW	kW	kW	kW	kW
100%	-19.8	-20.0	36.9	15.67	36.9	16.40	36.8	16.73	36.7	17.17	36.7	17.53	36.6	18.32
	-18.8	-19.0	37.2	15.78	37.2	16.42	37.1	16.81	37.0	17.16	37.0	17.61	36.9	18.28
	-16.7	-17.0	37.9	15.88	37.9	16.57	37.8	16.84	37.7	17.17	37.6	17.56	37.5	18.20
	-13.7	-15.0	38.6	16.00	38.5	16.60	38.4	16.84	38.4	17.24	38.2	17.49	38.1	18.18
	-11.8	-13.0	39.2	16.07	39.1	16.54	39.0	16.83	39.0	17.12	38.8	16.76	38.2	17.77
	-9.8	-11.0	39.9	16.02	39.8	16.55	39.7	16.71	39.6	17.00	39.4	17.26	38.2	17.27
	-9.5	-10.0	40.2	15.98	40.1	16.47	40.0	16.64	40.0	16.97	39.7	17.14	38.2	17.09
	-8.5	-9.1	40.4	15.91	40.3	16.34	40.2	16.55	40.3	16.85	39.9	17.04	38.2	16.81
	-7.0	-7.6	40.8	15.83	40.7	16.23	40.6	16.41	40.6	16.66	40.4	16.84	38.2	16.46
	-5.0	-5.6	43.1	16.26	43.0	16.68	42.9	16.80	42.9	17.14	41.6	16.83	39.1	16.26
	-3.0	-3.7	43.7	16.09	43.6	16.42	43.5	16.58	43.3	16.75	41.6	16.30	39.4	15.48
	0.0	-0.7	44.6	15.72	44.5	15.99	44.4	16.11	43.7	15.90	42.2	15.29	39.4	14.08
	3.0	2.2	48.1	16.13	48.0	16.42	45.0	14.97	43.7	14.46	42.2	13.93	39.4	12.82
	5.0	4.1	50.5	16.42	48.0	15.42	45.0	14.09	43.7	13.62	42.2	13.12	39.4	12.09
	7.0	6.0	50.8	15.58	48.0	14.50	45.0	13.08	43.7	12.83	42.2	12.36	39.4	11.40
	9.0	7.9	50.8	14.64	48.0	13.64	45.0	12.42	43.7	12.09	42.2	11.65	39.4	10.76
	11.0	9.8	50.8	13.79	48.0	12.86	45.0	11.73	43.7	11.41	42.2	11.00	39.4	10.17
	13.0	11.8	50.8	12.95	48.0	12.09	45.0	11.05	43.7	10.75	42.2	10.38	39.4	9.60
	15.0	13.7	50.8	12.21	48.0	11.41	45.0	10.45	43.7	10.17	42.2	9.81	39.4	9.10
	18.0	16.8	50.8	11.52	48.0	10.89	45.0	10.11	43.7	9.65	42.2	9.29	39.4	8.66
20.0	18.5	50.8	10.87	48.0	10.45	45.0	9.70	43.7	9.22	42.2	8.86	39.4	8.31	
24.0	20.5	50.8	10.28	48.0	10.10	45.0	9.33	43.7	8.88	42.2	8.51	39.4	8.05	
90%	-19.8	-20.0	36.8	16.89	36.7	17.52	36.7	17.76	36.8	18.24	36.7	18.59	34.5	18.12
	-18.8	-19.0	37.1	16.97	37.1	17.54	37.0	17.84	37.1	18.23	37.0	18.55	34.6	18.02
	-16.7	-17.0	37.8	17.02	37.7	17.62	37.7	17.80	37.7	18.19	37.8	18.62	34.6	17.63
	-13.7	-15.0	38.5	17.03	38.4	17.58	38.3	17.75	38.4	18.01	37.8	18.23	34.7	17.23
	-11.8	-13.0	39.1	17.01	39.0	17.46	38.9	17.67	39.0	18.01	37.8	17.75	34.7	16.82
	-9.8	-11.0	39.7	16.89	39.7	17.30	39.6	17.49	39.4	17.69	37.9	17.29	34.7	16.36
	-9.5	-10.0	40.1	16.81	40.0	17.29	39.9	17.38	39.4	17.49	37.9	17.10	35.0	16.18
	-8.5	-9.1	40.4	16.78	40.3	17.16	40.2	17.32	39.4	17.21	37.9	16.82	35.4	16.10
	-7.0	-7.6	40.7	16.59	40.7	16.99	40.7	17.15	39.3	16.82	37.8	16.42	35.4	15.37
	-5.0	-5.6	43.0	17.02	43.0	17.42	40.6	16.55	39.2	16.19	38.0	15.70	35.4	14.46
	-3.0	-3.7	43.5	16.76	43.6	15.25	40.6	15.93	39.2	15.35	38.0	14.80	35.4	13.63
	0.0	-0.7	44.4	16.24	43.7	14.26	40.6	14.48	39.2	13.95	38.0	13.46	35.4	12.40
	3.0	2.2	45.8	15.49	43.7	14.58	40.6	13.20	39.2	12.74	38.0	12.29	35.4	11.35
	5.0	4.1	46.7	14.87	43.7	13.72	40.6	12.45	39.2	12.00	38.0	11.60	35.4	10.71
	7.0	6.0	46.7	13.98	43.7	12.92	40.6	11.74	39.2	11.34	38.0	10.94	35.4	10.12
	9.0	7.9	46.7	13.18	43.7	12.16	40.6	11.07	39.2	10.70	38.0	10.34	35.4	9.56
	11.0	9.8	46.7	12.41	43.7	11.48	40.6	10.47	39.2	10.12	38.0	9.77	35.4	9.06
	13.0	11.8	46.7	11.68	43.7	10.82	40.6	9.87	39.2	9.55	38.0	9.23	35.4	8.56
	15.0	13.7	46.7	11.04	43.7	10.22	40.6	9.36	39.2	9.02	38.0	8.75	35.4	8.12
	18.0	16.8	46.7	10.42	43.7	9.66	40.6	8.88	39.2	8.52	38.0	8.30	35.4	7.72
20.0	18.5	46.7	9.85	43.7	9.13	40.6	8.43	39.2	8.03	38.0	7.88	35.4	7.38	
24.0	20.5	46.7	9.30	43.7	8.62	40.6	8.00	39.2	7.59	38.0	7.49	35.4	7.05	

TC—Total capacity of outdoor unit; PI—Power input of outdoor unit														
combination	outdoor air temp		indoor air temperature °C DB											
			16		18		20		21		22		24	
	°C DB	°C WB	TC kW	PI kW	TC kW	PI kW	TC kW	PI kW	TC kW	PI kW	TC kW	PI kW	TC kW	PI kW
80%	-19.8	-20.0	36.7	18.12	36.7	18.69	36.2	18.61	34.9	18.25	33.5	17.93	30.8	16.98
	-18.8	-19.0	37.1	18.17	37.0	18.67	36.3	18.50	34.9	18.14	33.5	17.72	30.8	16.87
	-16.7	-17.0	37.7	18.15	37.7	18.68	36.3	18.13	34.9	17.75	33.6	17.33	30.8	16.46
	-13.7	-15.0	38.4	18.08	38.3	18.58	36.4	17.73	35.0	17.33	33.6	16.99	31.1	16.16
	-11.8	-13.0	39.0	18.00	38.9	18.40	36.4	17.32	35.0	16.93	33.6	16.52	31.5	15.61
	-9.8	-11.0	39.7	17.81	39.2	17.99	36.4	16.85	35.1	16.44	33.8	16.01	31.5	14.75
	-9.5	-10.0	40.0	17.69	39.2	17.79	36.4	16.57	35.1	16.19	33.8	15.55	31.5	14.31
	-8.5	-9.1	40.2	17.58	39.2	17.51	36.4	16.36	35.1	15.80	33.8	15.14	31.5	13.93
	-7.0	-7.6	40.6	17.40	39.1	17.09	36.4	15.70	35.0	15.05	33.8	14.47	31.5	13.38
	-5.0	-5.6	41.6	15.34	38.9	16.30	36.1	14.68	35.0	14.14	33.8	13.62	31.5	12.55
	-3.0	-3.7	41.6	14.83	38.9	15.34	36.1	13.83	35.0	13.39	33.8	12.84	31.5	11.86
	0.0	-0.7	41.6	15.08	38.9	13.93	36.1	12.60	35.0	12.16	33.8	11.71	31.5	10.82
	3.0	2.2	41.6	13.74	38.9	12.70	36.1	11.53	35.0	11.12	33.8	10.73	31.5	9.92
	5.0	4.1	41.6	12.94	38.9	11.98	36.1	10.88	35.0	10.50	33.8	10.14	31.5	9.39
	7.0	6.0	41.6	12.19	38.9	11.32	36.1	10.28	35.0	9.93	33.8	9.59	31.5	8.88
	9.0	7.9	41.6	11.51	38.9	10.67	36.1	9.77	35.0	9.38	33.8	9.07	31.5	8.42
	11.0	9.8	41.6	10.87	38.9	10.08	36.1	9.20	35.0	8.88	33.8	8.59	31.5	7.98
	13.0	11.8	41.6	10.24	38.9	9.52	36.1	8.71	35.0	8.40	33.8	8.12	31.5	7.55
	15.0	13.7	41.6	9.69	38.9	9.02	36.1	8.26	35.0	7.97	33.8	7.71	31.5	7.18
	18.0	16.8	41.6	9.24	38.9	8.57	36.1	7.85	35.0	7.57	33.8	7.31	31.5	6.85
20.0	18.5	41.6	8.89	38.9	8.22	36.1	7.51	35.0	7.23	33.8	6.96	31.5	6.54	
24.0	20.5	41.6	8.62	38.9	7.95	36.1	7.20	35.0	6.92	33.8	6.65	31.5	6.26	
70%	-19.8	-20.0	36.5	19.24	34.1	18.49	31.7	17.25	30.6	16.88	29.4	16.49	27.5	15.75
	-18.8	-19.0	36.5	19.13	34.1	18.29	31.8	17.12	30.6	16.75	29.4	16.37	27.5	15.42
	-16.7	-17.0	36.6	18.72	34.2	17.89	31.8	16.72	30.6	16.36	29.4	15.93	27.5	14.72
	-13.7	-15.0	36.6	18.29	34.2	17.53	31.8	16.32	30.7	15.85	29.5	15.18	27.5	14.00
	-11.8	-13.0	36.6	17.86	34.2	17.02	31.8	15.57	30.7	15.03	29.5	14.40	27.5	13.27
	-9.8	-11.0	36.7	17.34	34.3	16.39	31.9	14.75	30.7	14.23	29.6	13.63	27.5	12.56
	-9.5	-10.0	36.7	17.07	34.3	15.92	31.9	14.33	30.8	13.83	29.6	13.26	27.5	12.22
	-8.5	-9.1	36.7	16.82	34.3	15.49	31.9	13.96	30.8	13.47	29.6	12.92	27.5	11.91
	-7.0	-7.6	36.6	16.03	34.2	14.77	31.8	13.34	30.7	12.88	29.5	12.34	27.5	11.41
	-5.0	-5.6	36.4	14.97	34.0	13.82	31.7	12.49	30.5	12.05	29.5	11.63	27.5	10.77
	-3.0	-3.7	36.4	14.10	34.0	13.02	31.7	11.80	30.5	11.39	29.5	11.00	27.5	10.18
	0.0	-0.7	36.4	12.83	34.0	11.93	31.7	10.78	30.5	10.41	29.5	10.07	27.5	9.33
	3.0	2.2	36.4	11.73	34.0	10.87	31.7	9.90	30.5	9.56	29.5	9.24	27.5	8.57
	5.0	4.1	36.4	11.07	34.0	10.25	31.7	9.37	30.5	9.04	29.5	8.76	27.5	8.12
	7.0	6.0	36.4	10.46	34.0	9.70	31.7	8.85	30.5	8.56	29.5	8.29	27.5	7.70
	9.0	7.9	36.4	9.89	34.0	9.17	31.7	8.39	30.5	8.12	29.5	7.86	27.5	7.30
	11.0	9.8	36.4	9.35	34.0	8.68	31.7	7.96	30.5	7.70	29.5	7.46	27.5	6.94
	13.0	11.8	36.4	8.84	34.0	8.22	31.7	7.54	30.5	7.31	29.5	7.07	27.5	6.59
	15.0	13.7	36.4	8.37	34.0	7.80	31.7	7.16	30.5	6.95	29.5	6.72	27.5	6.28
	18.0	16.8	36.4	7.94	34.0	7.40	31.7	6.82	30.5	6.62	29.5	6.41	27.5	6.00
20.0	18.5	36.4	7.57	34.0	7.05	31.7	6.51	30.5	6.32	29.5	6.13	27.5	5.76	
24.0	20.5	36.4	7.23	34.0	6.73	31.7	6.26	30.5	6.06	29.5	5.91	27.5	5.55	

GMV6 HR DC Inverter VRF Units Technical Sales Guide

TC—Total capacity of outdoor unit; PI—Power input of outdoor unit														
combination	outdoor air temp		indoor air temperature °C DB											
			16		18		20		21		22		24	
	°C DB	°C WB	TC kW	PI kW	TC kW	PI kW	TC kW	PI kW	TC kW	PI kW	TC kW	PI kW	TC kW	PI kW
60%	-19.8	-20.0	31.4	17.65	29.3	16.86	27.2	15.29	26.3	14.71	25.4	14.18	23.7	13.07
	-18.8	-19.0	31.4	17.52	29.3	16.65	27.2	14.99	26.3	14.42	25.4	13.88	23.7	12.80
	-16.7	-17.0	31.4	17.08	29.4	15.98	27.3	14.33	26.3	13.79	25.4	13.26	23.7	12.25
	-13.7	-15.0	31.5	16.54	29.4	15.21	27.3	13.66	26.4	13.15	25.4	12.63	23.7	11.66
	-11.8	-13.0	31.5	15.65	29.4	14.41	27.3	12.97	26.4	12.49	25.4	12.00	23.7	11.09
	-9.8	-11.0	31.6	14.81	29.5	13.64	27.4	12.31	26.4	11.84	25.4	11.36	23.7	10.52
	-9.5	-10.0	31.6	14.40	29.5	13.27	27.4	11.97	26.4	11.54	25.4	11.06	23.7	10.23
	-8.5	-9.1	31.6	14.02	29.5	12.93	27.4	11.68	26.4	11.25	25.4	10.78	23.7	9.99
	-7.0	-7.6	31.5	13.38	29.4	12.36	27.3	11.16	26.4	10.76	25.4	10.33	23.7	9.59
	-5.0	-5.6	31.3	12.53	29.2	11.57	27.2	10.48	26.2	10.10	25.4	9.77	23.7	9.07
	-3.0	-3.7	31.3	11.83	29.2	10.94	27.2	9.96	26.2	9.57	25.4	9.25	23.7	8.59
	0.0	-0.7	31.3	10.81	29.2	10.01	27.2	9.10	26.2	8.79	25.4	8.49	23.7	7.89
	3.0	2.2	31.3	9.91	29.2	9.20	27.2	8.39	26.2	8.08	25.4	7.84	23.7	7.28
	5.0	4.1	31.3	9.37	29.2	8.70	27.2	7.94	26.2	7.67	25.4	7.43	23.7	6.92
	7.0	6.0	31.3	8.87	29.2	8.24	27.2	7.53	26.2	7.28	25.4	7.06	23.7	6.58
	9.0	7.9	31.3	8.40	29.2	7.81	27.2	7.15	26.2	6.92	25.4	6.70	23.7	6.26
	11.0	9.8	31.3	7.97	29.2	7.42	27.2	6.81	26.2	6.57	25.4	6.37	23.7	5.97
	13.0	11.8	31.3	7.54	29.2	7.03	27.2	6.47	26.2	6.25	25.4	6.06	23.7	5.67
	15.0	13.7	31.3	7.18	29.2	6.68	27.2	6.16	26.2	5.95	25.4	5.78	23.7	5.41
	18.0	16.8	31.3	6.85	29.2	6.35	27.2	5.89	26.2	5.69	25.4	5.54	23.7	5.18
20.0	18.5	31.3	6.57	29.2	6.06	27.2	5.65	26.2	5.47	25.4	5.33	23.7	4.99	
24.0	20.5	31.3	6.31	29.2	5.82	27.2	5.44	26.2	5.28	25.4	5.16	23.7	4.82	
50%	-19.8	-20.0	26.2	14.82	24.4	13.62	22.7	12.25	21.8	11.86	21.1	11.43	19.7	10.58
	-18.8	-19.0	26.2	14.52	24.4	13.35	22.7	12.03	21.9	11.61	21.1	11.19	19.7	10.38
	-16.7	-17.0	26.2	13.86	24.4	12.76	22.7	11.52	21.9	11.13	21.1	10.73	19.7	9.95
	-13.7	-15.0	26.3	13.23	24.5	12.18	22.8	11.00	21.9	10.64	21.1	10.24	19.7	9.50
	-11.8	-13.0	26.3	12.56	24.5	11.59	22.8	10.47	21.9	10.13	21.1	9.74	19.7	9.05
	-9.8	-11.0	26.3	11.91	24.5	10.99	22.8	9.96	22.0	9.63	21.1	9.26	19.7	8.60
	-9.5	-10.0	26.3	11.59	24.5	10.69	22.8	9.71	22.0	9.40	21.1	9.02	19.7	8.38
	-8.5	-9.1	26.3	11.30	24.5	10.44	22.8	9.47	22.0	9.17	21.1	8.81	19.7	8.19
	-7.0	-7.6	26.3	10.81	24.5	10.03	22.8	9.08	21.9	8.80	21.1	8.47	19.7	7.87
	-5.0	-5.6	26.1	10.14	24.3	9.39	22.7	8.55	21.8	8.28	21.1	8.02	19.7	7.46
	-3.0	-3.7	26.1	9.60	24.3	8.89	22.7	8.11	21.8	7.86	21.1	7.61	19.7	7.09
	0.0	-0.7	26.1	8.82	24.3	8.17	22.7	7.48	21.8	7.24	21.1	7.02	19.7	6.56
	3.0	2.2	26.1	8.12	24.3	7.53	22.7	6.90	21.8	6.69	21.1	6.51	19.7	6.07
	5.0	4.1	26.1	7.70	24.3	7.14	22.7	6.56	21.8	6.36	21.1	6.18	19.7	5.78
	7.0	6.0	26.1	7.31	24.3	6.79	22.7	6.25	21.8	6.06	21.1	5.88	19.7	5.52
	9.0	7.9	26.1	6.93	24.3	6.46	22.7	5.94	21.8	5.78	21.1	5.61	19.7	5.26
	11.0	9.8	26.1	6.59	24.3	6.14	22.7	5.67	21.8	5.50	21.1	5.35	19.7	5.01
	13.0	11.8	26.1	6.27	24.3	5.84	22.7	5.39	21.8	5.25	21.1	5.09	19.7	4.79
	15.0	13.7	26.1	5.97	24.3	5.57	22.7	5.15	21.8	5.01	21.1	4.86	19.7	4.56
	18.0	16.8	26.1	5.67	24.3	5.31	22.7	4.96	21.8	4.80	21.1	4.65	19.7	4.35
20.0	18.5	26.1	5.41	24.3	5.08	22.7	4.77	21.8	4.63	21.1	4.46	19.7	4.16	
24.0	20.5	26.1	5.16	24.3	4.87	22.7	4.44	21.8	4.47	21.1	4.29	19.7	3.98	

GMV-VQ450WM/C-X

TC—Total capacity of outdoor unit; PI—Power input of outdoor unit														
combination	outdoor air temp		indoor air temperature °C DB											
			16		18		20		21		22		24	
	°C DB	°C WB	TC	PI	TC	PI	TC	PI	TC	PI	TC	PI	TC	PI
135%	-19.8	-20.0	39.4	14.99	39.3	16.08	39.3	16.96	39.2	17.50	39.1	18.14	39.1	19.24
	-18.8	-19.0	39.9	15.30	39.8	16.36	39.7	17.12	39.6	17.74	39.6	18.26	39.5	19.42
	-16.7	-17.0	40.8	15.75	40.7	16.77	40.5	17.52	40.5	17.95	40.5	18.58	40.4	19.65
	-13.7	-15.0	41.6	16.16	41.6	17.14	41.5	17.85	41.5	18.33	41.4	18.91	41.3	19.87
	-11.8	-13.0	42.6	16.58	42.4	17.39	42.3	18.03	42.3	18.57	42.2	19.04	42.2	20.02
	-9.8	-11.0	43.4	16.87	43.4	17.73	43.2	18.28	43.2	18.71	43.2	19.19	43.1	20.07
	-9.5	-10.0	43.8	16.97	43.8	17.79	43.6	18.30	43.7	18.77	43.6	19.25	43.6	20.06
	-8.5	-9.1	44.3	17.12	44.2	17.87	44.1	18.34	44.1	18.81	44.1	19.26	43.9	20.09
	-7.0	-7.6	44.9	17.25	44.9	17.95	44.7	18.39	44.8	18.82	44.7	19.27	44.7	20.10
	-5.0	-5.6	45.6	17.27	45.6	17.61	45.4	18.36	45.5	18.76	45.4	19.16	45.4	19.85
	-3.0	-3.7	46.5	17.34	46.4	17.99	46.2	18.26	46.3	18.71	46.2	19.04	46.2	19.73
	0.0	-0.7	49.9	18.12	49.9	18.68	49.8	18.97	49.8	19.29	49.6	19.63	49.6	20.23
	3.0	2.2	66.7	23.33	66.6	24.03	66.1	24.24	63.6	23.68	61.1	23.12	56.1	21.86
	5.0	4.1	75.2	25.67	70.2	24.67	65.3	23.19	62.8	22.71	60.4	22.15	56.1	21.18
	7.0	6.0	75.2	25.04	70.3	23.98	65.3	22.54	62.9	19.68	60.4	21.47	56.8	20.24
	9.0	7.9	75.3	24.34	70.4	23.31	65.4	21.86	62.9	21.37	60.9	20.73	56.8	19.03
	11.0	9.8	75.3	23.63	70.4	22.57	65.4	21.11	62.9	20.26	60.9	19.48	56.8	17.92
13.0	11.8	75.3	22.86	70.4	21.82	65.4	19.80	62.9	18.99	60.9	18.29	56.8	16.82	
15.0	13.7	75.3	22.18	70.4	20.56	65.4	18.66	62.9	17.92	60.9	17.24	56.8	15.88	
18.0	16.8	75.3	21.00	70.4	19.57	65.4	17.70	62.9	17.02	60.9	16.30	56.8	15.09	
20.0	18.5	75.3	19.99	70.4	18.70	65.4	16.90	62.9	16.26	60.9	15.49	56.8	14.41	
24.0	20.5	75.3	19.12	70.4	17.99	65.4	16.25	62.9	15.64	60.9	14.79	56.8	13.89	
120%	-19.8	-20.0	39.3	16.48	39.3	17.50	39.1	18.21	39.1	18.75	39.1	19.27	39.0	20.40
	-18.8	-19.0	39.8	16.72	39.7	17.74	39.5	18.14	39.6	18.95	39.5	19.48	39.5	20.57
	-16.7	-17.0	40.6	17.09	40.5	18.06	40.5	18.62	40.4	19.20	40.5	19.74	40.3	20.71
	-13.7	-15.0	41.6	17.46	41.4	18.32	41.4	18.92	41.4	19.45	41.3	19.91	41.3	20.88
	-11.8	-13.0	42.4	17.76	42.3	18.54	42.2	19.05	42.2	19.54	42.2	20.05	42.1	20.89
	-9.8	-11.0	43.3	17.97	43.2	18.76	43.2	19.19	43.1	19.68	43.2	20.12	43.0	20.98
	-9.5	-10.0	43.7	18.03	43.6	18.80	43.6	19.26	43.5	19.66	43.6	19.94	43.4	20.89
	-8.5	-9.1	44.2	18.15	44.1	18.89	44.1	19.26	44.0	19.71	43.9	20.12	43.9	20.93
	-7.0	-7.6	44.8	18.23	44.7	18.86	44.7	19.27	44.6	19.63	44.7	20.10	44.5	20.75
	-5.0	-5.6	45.6	18.18	45.4	18.79	45.4	19.16	45.3	19.49	45.4	19.87	45.2	20.52
	-3.0	-3.7	46.3	18.16	46.2	18.70	46.2	19.01	46.1	19.32	46.2	19.75	46.0	20.29
	0.0	-0.7	49.8	18.87	49.8	19.38	49.6	19.85	49.6	19.93	49.5	20.24	49.5	20.81
	3.0	2.2	66.6	24.26	65.7	24.56	61.1	23.07	58.8	22.61	56.5	22.02	52.3	20.77
	5.0	4.1	69.4	24.59	64.9	23.56	60.3	22.10	58.0	21.62	56.1	21.19	52.3	19.52
	7.0	6.0	69.5	23.90	64.9	22.80	60.4	21.43	58.1	20.73	56.3	19.96	52.3	18.37
	9.0	7.9	69.5	23.22	65.0	22.18	60.4	20.38	58.2	19.50	56.3	18.78	52.3	17.29
	11.0	9.8	69.5	22.48	65.0	21.16	60.4	19.18	58.2	18.37	56.3	17.68	52.3	16.30
13.0	11.8	69.5	21.48	65.0	19.84	60.4	17.99	58.2	17.25	56.3	16.63	52.3	15.33	
15.0	13.7	69.5	20.23	65.0	18.69	60.4	16.99	58.2	16.27	56.3	15.69	52.3	14.48	
18.0	16.8	69.5	19.11	65.0	17.70	60.4	16.14	58.2	15.42	56.3	14.86	52.3	13.73	
20.0	18.5	69.5	18.11	65.0	16.89	60.4	15.44	58.2	14.71	56.3	14.16	52.3	13.08	
24.0	20.5	69.5	17.23	65.0	16.20	60.4	14.88	58.2	14.10	56.3	13.60	52.3	12.54	

GMV6 HR DC Inverter VRF Units Technical Sales Guide

TC—Total capacity of outdoor unit; PI—Power input of outdoor unit														
combination	outdoor air temp		indoor air temperature °C DB											
			16		18		20		21		22		24	
	°C DB	°C WB	TC	PI	TC	PI	TC	PI	TC	PI	TC	PI	TC	PI
			kW	kW	kW	kW	kW	kW	kW	kW	kW	kW	kW	kW
110%	-19.8	-20.0	39.2	17.93	39.1	18.87	39.0	19.51	39.0	19.98	39.0	20.51	38.9	21.57
	-18.8	-19.0	39.6	18.14	39.5	18.98	39.5	19.59	39.5	20.11	39.5	20.68	39.4	21.60
	-16.7	-17.0	40.5	18.47	40.5	19.37	40.3	19.79	40.4	20.37	40.3	20.84	40.2	21.80
	-13.7	-15.0	41.4	18.72	41.4	19.57	41.3	20.07	41.2	20.50	41.3	20.99	41.1	21.85
	-11.8	-13.0	42.2	18.97	42.2	19.67	42.1	20.12	42.2	20.56	42.1	21.06	42.0	21.85
	-9.8	-11.0	43.2	19.12	43.2	19.86	43.0	20.14	43.1	20.66	43.0	21.03	42.9	21.76
	-9.5	-10.0	43.6	19.13	43.6	19.83	43.5	20.24	43.5	20.60	43.4	20.96	43.3	21.74
	-8.5	-9.1	44.1	19.22	44.0	19.86	43.9	20.16	43.9	20.56	43.9	21.00	43.8	21.66
	-7.0	-7.6	44.7	19.25	44.7	19.80	44.6	20.14	44.6	20.49	44.5	20.59	44.4	21.55
	-5.0	-5.6	45.4	19.07	45.4	19.68	45.3	19.96	45.3	20.27	45.7	19.87	45.1	21.27
	-3.0	-3.7	46.2	19.02	46.2	19.49	46.1	19.76	46.1	20.05	49.5	20.26	46.0	20.97
	0.0	-0.7	49.6	19.61	49.6	20.08	49.5	20.27	49.5	20.55	51.5	20.87	48.0	20.52
	3.0	2.2	64.6	24.43	60.3	23.34	56.0	21.86	54.0	21.37	51.9	20.44	48.0	18.68
	5.0	4.1	63.8	23.39	59.5	22.28	55.3	20.66	53.3	19.83	51.5	19.10	48.0	17.58
	7.0	6.0	63.8	22.70	59.6	21.49	55.4	19.44	53.3	18.67	51.5	17.96	48.0	16.54
	9.0	7.9	63.9	21.97	59.6	20.22	55.4	18.32	53.4	17.60	51.5	16.91	48.0	15.60
	11.0	9.8	63.9	20.66	59.6	19.02	55.4	17.25	53.4	16.59	51.5	15.95	48.0	14.72
	13.0	11.8	63.9	19.38	59.6	17.85	55.4	16.23	53.4	15.61	51.5	15.01	48.0	13.87
	15.0	13.7	63.9	18.26	59.6	16.83	55.4	15.33	53.4	14.74	51.5	14.20	48.0	13.12
	18.0	16.8	63.9	17.28	59.6	15.96	55.4	13.99	53.4	13.98	51.5	13.53	48.0	12.49
20.0	18.5	63.9	16.40	59.6	15.17	55.4	13.28	53.4	13.30	51.5	12.96	48.0	11.95	
24.0	20.5	63.9	15.65	59.6	14.48	55.4	12.65	53.4	12.74	51.5	12.49	48.0	11.50	
100%	-19.8	-20.0	39.0	19.37	38.9	20.21	38.8	20.60	38.7	21.16	38.7	21.60	38.5	22.53
	-18.8	-19.0	39.4	19.55	39.3	20.29	39.2	20.75	39.2	21.20	39.1	21.75	39.0	22.59
	-16.7	-17.0	40.3	19.76	40.2	20.55	40.1	20.87	40.1	21.34	39.9	21.78	39.8	22.58
	-13.7	-15.0	41.2	19.98	41.0	20.68	40.9	20.96	41.0	21.52	40.7	21.78	40.6	22.64
	-11.8	-13.0	42.1	20.14	42.0	20.74	41.8	21.08	41.8	21.46	41.6	21.00	41.5	22.58
	-9.8	-11.0	42.9	20.15	42.8	20.82	42.7	21.01	42.8	21.43	42.4	21.71	42.3	22.36
	-9.5	-10.0	43.3	20.14	43.2	20.76	43.1	20.96	43.2	21.43	42.8	21.60	42.4	22.18
	-8.5	-9.1	43.7	20.14	43.6	20.68	43.5	20.93	43.5	21.26	43.2	21.57	42.4	21.82
	-7.0	-7.6	44.3	20.07	44.2	20.57	44.1	20.78	44.1	21.16	43.8	21.34	42.4	21.36
	-5.0	-5.6	44.6	19.67	44.5	20.18	44.4	20.32	44.4	20.73	44.4	21.00	43.4	21.11
	-3.0	-3.7	45.8	19.73	45.8	20.18	45.7	20.33	45.7	20.62	45.7	20.91	43.8	20.11
	0.0	-0.7	49.5	20.39	49.5	20.79	49.3	20.91	48.5	20.64	46.9	19.85	43.8	18.29
	3.0	2.2	57.7	22.62	53.8	21.54	50.0	19.44	48.5	18.77	46.9	18.09	43.8	16.65
	5.0	4.1	57.7	21.93	53.8	20.24	50.0	18.29	48.5	17.68	46.9	17.04	43.8	15.71
	7.0	6.0	57.7	20.69	53.8	19.02	50.0	16.36	48.5	16.66	46.9	16.05	43.8	14.81
	9.0	7.9	57.7	19.44	53.8	17.90	50.0	16.12	48.5	15.70	46.9	15.13	43.8	13.98
	11.0	9.8	57.7	18.31	53.8	16.87	50.0	15.23	48.5	14.81	46.9	14.28	43.8	13.21
	13.0	11.8	57.7	17.19	53.8	15.86	50.0	14.35	48.5	13.96	46.9	13.48	43.8	12.47
	15.0	13.7	57.7	16.22	53.8	14.97	50.0	13.56	48.5	13.20	46.9	12.74	43.8	11.81
	18.0	16.8	57.7	15.29	53.8	14.28	50.0	13.12	48.5	12.53	46.9	12.06	43.8	11.25
20.0	18.5	57.7	14.43	53.8	13.71	50.0	12.59	48.5	11.97	46.9	11.50	43.8	10.80	
24.0	20.5	57.7	13.64	53.8	13.25	50.0	12.11	48.5	11.53	46.9	11.05	43.8	10.46	

TC—Total capacity of outdoor unit; PI—Power input of outdoor unit														
combination	outdoor air temp		indoor air temperature °C DB											
			16		18		20		21		22		24	
	°C DB	°C WB	TC kW	PI kW	TC kW	PI kW	TC kW	PI kW	TC kW	PI kW	TC kW	PI kW	TC kW	PI kW
90%	-19.8	-20.0	38.8	20.83	38.8	21.61	38.7	21.89	38.8	22.48	38.7	22.92	38.4	23.53
	-18.8	-19.0	39.3	20.97	39.2	21.67	39.1	22.03	39.2	22.51	39.1	22.92	38.4	23.39
	-16.7	-17.0	40.2	21.18	40.1	21.92	40.1	22.13	40.1	22.56	40.1	23.10	38.4	22.89
	-13.7	-15.0	41.1	21.27	41.0	21.97	41.0	22.15	41.0	22.49	41.0	23.07	38.5	22.37
	-11.8	-13.0	41.9	21.33	41.8	21.89	41.8	22.14	41.9	22.57	41.8	22.91	38.5	21.84
	-9.8	-11.0	42.9	21.31	42.8	21.83	42.7	22.05	42.7	22.42	42.1	22.43	38.6	21.24
	-9.5	-10.0	43.3	21.24	43.2	21.85	43.2	21.95	43.2	22.38	42.1	22.18	38.8	21.01
	-8.5	-9.1	43.6	21.19	43.6	21.72	43.6	21.91	43.6	22.23	42.1	21.81	39.3	20.90
	-7.0	-7.6	44.2	21.09	44.2	21.54	44.1	21.72	43.8	21.88	42.0	21.29	39.3	19.96
	-5.0	-5.6	44.5	20.60	44.5	21.09	44.4	21.15	43.5	21.00	42.2	20.39	39.3	18.77
	-3.0	-3.7	45.7	20.55	45.7	18.68	45.1	20.68	43.5	19.91	42.2	19.21	39.3	17.70
	0.0	-0.7	49.5	21.13	48.0	18.34	45.1	18.79	43.5	18.10	42.2	17.47	39.3	16.11
	3.0	2.2	52.0	20.55	48.6	18.97	45.1	17.14	43.5	16.53	42.2	15.95	39.3	14.74
	5.0	4.1	52.0	19.33	48.6	17.84	45.1	16.17	43.5	15.57	42.2	15.06	39.3	13.90
	7.0	6.0	52.0	18.17	48.6	16.81	45.1	15.24	43.5	14.71	42.2	14.21	39.3	13.14
	9.0	7.9	52.0	17.13	48.6	15.82	45.1	14.38	43.5	13.88	42.2	13.42	39.3	12.42
	11.0	9.8	52.0	16.13	48.6	14.93	45.1	13.60	43.5	13.13	42.2	12.68	39.3	11.77
	13.0	11.8	52.0	15.18	48.6	14.08	45.1	12.82	43.5	12.39	42.2	11.99	39.3	11.11
	15.0	13.7	52.0	14.35	48.6	13.30	45.1	12.16	43.5	11.70	42.2	11.36	39.3	10.55
	18.0	16.8	52.0	13.56	48.6	12.56	45.1	11.53	43.5	11.05	42.2	10.78	39.3	10.03
20.0	18.5	52.0	12.82	48.6	11.87	45.1	10.95	43.5	10.43	42.2	10.24	39.3	9.58	
24.0	20.5	52.0	12.10	48.6	11.21	45.1	10.40	43.5	9.85	42.2	9.72	39.3	9.15	
80%	-19.8	-20.0	38.8	22.34	38.7	23.05	38.6	23.19	38.6	23.60	37.2	23.29	34.1	21.99
	-18.8	-19.0	39.2	22.45	39.1	23.07	39.1	23.29	38.8	23.58	37.3	23.01	34.1	21.85
	-16.7	-17.0	40.0	22.53	40.0	23.19	39.9	23.30	38.9	23.08	37.3	22.51	34.2	21.32
	-13.7	-15.0	40.9	22.53	40.9	23.15	40.4	23.01	39.0	22.53	37.4	22.07	34.5	20.98
	-11.8	-13.0	41.8	22.57	41.8	23.08	40.4	22.48	39.0	22.01	37.4	21.45	35.0	20.26
	-9.8	-11.0	42.7	22.41	42.6	22.88	40.5	21.87	39.0	21.38	37.6	20.79	35.0	19.14
	-9.5	-10.0	43.1	22.31	43.1	22.84	40.5	21.51	39.0	21.05	37.6	20.19	35.0	18.59
	-8.5	-9.1	43.5	22.26	43.5	22.70	40.5	21.24	39.0	20.54	37.6	19.66	35.0	18.09
	-7.0	-7.6	44.0	22.06	43.5	22.20	40.4	20.38	39.0	19.57	37.6	18.79	35.0	17.38
	-5.0	-5.6	44.4	19.15	43.2	21.17	40.2	19.05	38.7	18.31	37.6	17.68	35.0	16.30
	-3.0	-3.7	45.2	18.85	43.2	19.93	40.2	17.95	38.7	17.34	37.6	16.68	35.0	15.40
	0.0	-0.7	46.3	19.64	43.2	18.09	40.2	16.36	38.7	15.74	37.6	15.20	35.0	14.06
	3.0	2.2	46.3	17.89	43.2	16.50	40.2	14.97	38.7	14.39	37.6	13.93	35.0	12.89
	5.0	4.1	46.3	16.84	43.2	15.56	40.2	14.13	38.7	13.59	37.6	13.17	35.0	12.19
	7.0	6.0	46.3	15.87	43.2	14.71	40.2	13.35	38.7	12.86	37.6	12.45	35.0	11.54
	9.0	7.9	46.3	14.98	43.2	13.86	40.2	12.69	38.7	12.15	37.6	11.78	35.0	10.93
	11.0	9.8	46.3	14.15	43.2	13.10	40.2	11.95	38.7	11.50	37.6	11.15	35.0	10.37
	13.0	11.8	46.3	13.33	43.2	12.36	40.2	11.31	38.7	10.88	37.6	10.55	35.0	9.80
	15.0	13.7	46.3	12.61	43.2	11.72	40.2	10.73	38.7	10.32	37.6	10.01	35.0	9.33
	18.0	16.8	46.3	12.03	43.2	11.14	40.2	10.21	38.7	9.81	37.6	9.49	35.0	8.90
20.0	18.5	46.3	11.57	43.2	10.68	40.2	9.77	38.7	9.36	37.6	9.04	35.0	8.49	
24.0	20.5	46.3	11.22	43.2	10.34	40.2	9.36	38.7	8.96	37.6	8.64	35.0	8.13	

GMV6 HR DC Inverter VRF Units Technical Sales Guide

TC—Total capacity of outdoor unit; PI—Power input of outdoor unit														
combination	outdoor air temp		indoor air temperature °C DB											
			16		18		20		21		22		24	
	TC	PI	TC	PI	TC	PI	TC	PI	TC	PI	TC	PI	TC	PI
	°C DB	°C WB	kW	kW	kW	kW	kW	kW	kW	kW	kW	kW	kW	kW
70%	-19.8	-20.0	38.6	23.81	37.9	24.05	35.2	22.38	34.0	21.93	32.6	21.39	30.6	20.45
	-18.8	-19.0	39.0	23.91	38.0	23.78	35.3	22.22	34.0	21.77	32.7	21.24	30.6	20.02
	-16.7	-17.0	39.9	23.88	38.0	23.26	35.3	21.71	34.1	21.26	32.7	20.67	30.6	19.11
	-13.7	-15.0	40.8	23.80	38.1	22.80	35.4	21.18	34.1	20.59	32.8	19.69	30.6	18.17
	-11.8	-13.0	40.8	23.24	38.1	22.13	35.4	20.21	34.1	19.53	32.8	18.67	30.6	17.23
	-9.8	-11.0	40.8	22.57	38.1	21.32	35.4	19.14	34.2	18.50	32.8	17.68	30.6	16.31
	-9.5	-10.0	40.8	22.21	38.2	20.70	35.5	18.60	34.2	17.97	32.8	17.20	30.6	15.87
	-8.5	-9.1	40.8	21.89	38.2	20.15	35.5	18.12	34.2	17.51	32.8	16.76	30.6	15.46
	-7.0	-7.6	40.8	20.86	38.1	19.21	35.4	17.31	34.1	16.74	32.8	16.01	30.6	14.81
	-5.0	-5.6	40.5	19.49	37.9	17.97	35.2	16.22	33.9	15.67	32.8	15.10	30.6	13.98
	-3.0	-3.7	40.5	18.35	37.9	16.94	35.2	15.32	33.9	14.80	32.8	14.28	30.6	13.22
	0.0	-0.7	40.5	16.70	37.9	15.51	35.2	14.00	33.9	13.54	32.8	13.07	30.6	12.12
	3.0	2.2	40.5	15.26	37.9	14.13	35.2	12.85	33.9	12.42	32.8	12.00	30.6	11.13
	5.0	4.1	40.5	14.40	37.9	13.33	35.2	12.16	33.9	11.76	32.8	11.37	30.6	10.54
	7.0	6.0	40.5	13.61	37.9	12.62	35.2	11.50	33.9	11.13	32.8	10.77	30.6	10.00
	9.0	7.9	40.5	12.87	37.9	11.93	35.2	10.90	33.9	10.55	32.8	10.21	30.6	9.49
	11.0	9.8	40.5	12.17	37.9	11.29	35.2	10.34	33.9	10.01	32.8	9.69	30.6	9.01
	13.0	11.8	40.5	11.50	37.9	10.69	35.2	9.79	33.9	9.50	32.8	9.17	30.6	8.56
	15.0	13.7	40.5	10.90	37.9	10.14	35.2	9.30	33.9	9.03	32.8	8.73	30.6	8.16
	18.0	16.8	40.5	10.34	37.9	9.63	35.2	8.85	33.9	8.60	32.8	8.32	30.6	7.79
20.0	18.5	40.5	9.85	37.9	9.17	35.2	8.45	33.9	8.22	32.8	7.96	30.6	7.48	
24.0	20.5	40.5	9.41	37.9	8.76	35.2	8.11	33.9	7.89	32.8	7.67	30.6	7.21	
60%	-19.8	-20.0	34.8	22.89	32.5	21.89	30.2	19.84	29.1	19.03	28.2	18.41	26.3	16.97
	-18.8	-19.0	34.8	22.72	32.6	21.61	30.3	19.45	29.1	18.66	28.2	18.01	26.3	16.61
	-16.7	-17.0	34.9	22.15	32.6	20.74	30.3	18.59	29.1	17.84	28.2	17.21	26.3	15.90
	-13.7	-15.0	34.9	21.44	32.7	19.74	30.4	17.73	29.2	17.02	28.2	16.39	26.3	15.14
	-11.8	-13.0	34.9	20.30	32.7	18.70	30.4	16.83	29.2	16.16	28.2	15.57	26.3	14.40
	-9.8	-11.0	35.0	19.20	32.7	17.71	30.4	15.97	29.2	15.32	28.2	14.75	26.3	13.66
	-9.5	-10.0	35.0	18.67	32.7	17.23	30.4	15.54	29.3	14.93	28.2	14.35	26.3	13.28
	-8.5	-9.1	35.0	18.18	32.7	16.79	30.4	15.16	29.3	14.56	28.2	13.99	26.3	12.97
	-7.0	-7.6	34.9	17.35	32.7	16.04	30.4	14.49	29.2	13.93	28.2	13.42	26.3	12.45
	-5.0	-5.6	34.7	16.25	32.5	15.02	30.2	13.61	29.0	13.08	28.2	12.68	26.3	11.78
	-3.0	-3.7	34.7	15.34	32.5	14.19	30.2	12.93	29.0	12.39	28.2	12.01	26.3	11.15
	0.0	-0.7	34.7	14.01	32.5	13.00	30.2	11.82	29.0	11.38	28.2	11.03	26.3	10.25
	3.0	2.2	34.7	12.85	32.5	11.94	30.2	10.89	29.0	10.47	28.2	10.18	26.3	9.46
	5.0	4.1	34.7	12.15	32.5	11.29	30.2	10.31	29.0	9.93	28.2	9.64	26.3	8.99
	7.0	6.0	34.7	11.50	32.5	10.69	30.2	9.78	29.0	9.42	28.2	9.17	26.3	8.54
	9.0	7.9	34.7	10.90	32.5	10.14	30.2	9.29	29.0	8.96	28.2	8.70	26.3	8.13
	11.0	9.8	34.7	10.34	32.5	9.63	30.2	8.84	29.0	8.51	28.2	8.27	26.3	7.75
	13.0	11.8	34.7	9.78	32.5	9.13	30.2	8.40	29.0	8.09	28.2	7.87	26.3	7.36
	15.0	13.7	34.7	9.31	32.5	8.67	30.2	7.99	29.0	7.71	28.2	7.51	26.3	7.03
	18.0	16.8	34.7	8.89	32.5	8.25	30.2	7.64	29.0	7.38	28.2	7.19	26.3	6.73
20.0	18.5	34.7	8.52	32.5	7.88	30.2	7.32	29.0	7.08	28.2	6.92	26.3	6.48	
24.0	20.5	34.7	8.20	32.5	7.56	30.2	7.05	29.0	6.84	28.2	6.70	26.3	6.26	

TC—Total capacity of outdoor unit; PI—Power input of outdoor unit														
combination	outdoor air temp		indoor air temperature °C DB											
			16		18		20		21		22		24	
	°C DB	°C WB	TC	PI	TC	PI	TC	PI	TC	PI	TC	PI	TC	PI
50%	-19.8	-20.0	29.0	19.20	27.1	17.70	25.2	15.90	24.3	15.39	23.4	14.80	21.8	13.74
	-18.8	-19.0	29.0	18.80	27.1	17.35	25.3	15.61	24.3	15.08	23.4	14.51	21.8	13.47
	-16.7	-17.0	29.1	17.96	27.2	16.58	25.3	14.95	24.3	14.45	23.4	13.92	21.8	12.91
	-13.7	-15.0	29.1	17.13	27.2	15.83	25.3	14.28	24.4	13.82	23.5	13.31	21.8	12.33
	-11.8	-13.0	29.1	16.27	27.2	15.07	25.3	13.60	24.4	13.15	23.5	12.66	21.8	11.75
	-9.8	-11.0	29.2	15.43	27.3	14.28	25.4	12.93	24.4	12.51	23.5	12.06	21.8	11.16
	-9.5	-10.0	29.2	15.02	27.3	13.90	25.4	12.61	24.4	12.20	23.5	11.75	21.8	10.87
	-8.5	-9.1	29.2	14.64	27.3	13.57	25.4	12.30	24.4	11.91	23.5	11.48	21.8	10.63
	-7.0	-7.6	29.1	14.01	27.2	13.04	25.3	11.79	24.4	11.42	23.5	11.01	21.8	10.22
	-5.0	-5.6	28.9	13.14	27.1	12.20	25.2	11.10	24.2	10.76	23.4	10.41	21.8	9.68
	-3.0	-3.7	28.9	12.44	27.1	11.56	25.2	10.53	24.2	10.20	23.4	9.88	21.8	9.21
	0.0	-0.7	28.9	11.42	27.1	10.62	25.2	9.71	24.2	9.40	23.4	9.12	21.8	8.51
	3.0	2.2	28.9	10.51	27.1	9.79	25.2	8.96	24.2	8.69	23.4	8.45	21.8	7.88
	5.0	4.1	28.9	9.98	27.1	9.29	25.2	8.52	24.2	8.27	23.4	8.02	21.8	7.50
	7.0	6.0	28.9	9.47	27.1	8.83	25.2	8.12	24.2	7.86	23.4	7.64	21.8	7.16
	9.0	7.9	28.9	8.98	27.1	8.39	25.2	7.72	24.2	7.51	23.4	7.28	21.8	6.82
	11.0	9.8	28.9	8.54	27.1	7.98	25.2	7.36	24.2	7.15	23.4	6.94	21.8	6.51
13.0	11.8	28.9	8.12	27.1	7.59	25.2	7.00	24.2	6.81	23.4	6.61	21.8	6.21	
15.0	13.7	28.9	7.73	27.1	7.24	25.2	6.69	24.2	6.50	23.4	6.31	21.8	5.92	
18.0	16.8	28.9	7.36	27.1	6.92	25.2	6.42	24.2	6.23	23.4	6.04	21.8	5.65	
20.0	18.5	28.9	7.01	27.1	6.62	25.2	6.18	24.2	6.01	23.4	5.80	21.8	5.40	
24.0	20.5	28.9	6.69	27.1	6.35	25.2	5.75	24.2	5.81	23.4	5.57	21.8	5.17	

GMV-VQ504WM/C-X

TC—Total capacity of outdoor unit; PI—Power input of outdoor unit														
combination	outdoor air temp		indoor air temperature °C DB											
			16		18		20		21		22		24	
	°C DB	°C WB	TC	PI	TC	PI	TC	PI	TC	PI	TC	PI	TC	PI
135%	-19.8	-20.0	46.6	14.76	45.5	15.51	44.6	16.04	44.1	16.41	43.8	16.89	42.9	17.59
	-18.8	-19.0	47.0	15.01	46.0	15.75	45.0	16.17	44.6	16.61	44.2	16.98	43.3	17.73
	-16.7	-17.0	47.8	15.37	46.8	16.07	45.9	16.51	45.4	16.77	45.1	17.21	44.2	17.92
	-13.7	-15.0	48.7	15.73	47.6	16.34	46.8	16.75	46.3	17.05	46.0	17.48	45.1	18.04
	-11.8	-13.0	49.4	16.02	48.4	16.55	47.6	16.88	47.1	17.24	46.8	17.57	46.0	18.19
	-9.8	-11.0	50.3	16.27	49.3	16.79	48.5	17.08	48.0	17.34	47.7	17.63	46.9	18.20
	-9.5	-10.0	50.7	16.34	49.7	16.83	48.9	17.08	48.4	17.34	48.1	17.67	47.3	18.14
	-8.5	-9.1	51.1	16.43	50.2	16.92	49.3	17.07	48.9	17.40	48.6	17.66	47.8	18.20
	-7.0	-7.6	51.7	16.53	50.9	16.93	50.0	17.12	49.5	17.35	49.2	17.65	48.4	18.14
	-5.0	-5.6	56.2	17.69	55.3	17.79	54.6	18.37	54.2	18.62	53.8	18.92	53.2	19.38
	-3.0	-3.7	56.9	17.67	56.1	18.12	55.4	18.22	55.0	18.52	54.7	18.75	54.0	19.21
	0.0	-0.7	58.3	17.61	57.4	17.89	56.7	17.99	56.4	18.21	56.1	18.48	56.1	19.03
	3.0	2.2	69.0	20.11	68.4	20.52	67.7	20.68	67.5	20.92	67.3	21.18	63.4	20.58
	5.0	4.1	85.0	24.17	79.3	23.21	73.8	21.84	71.0	21.37	68.2	20.84	63.4	19.93
	7.0	6.0	85.1	23.57	79.4	22.56	73.9	21.23	71.0	18.52	68.3	20.20	64.1	19.04
	9.0	7.9	85.1	22.91	79.5	21.93	73.9	20.59	71.1	20.10	68.8	19.50	64.1	17.90
	11.0	9.8	85.1	22.25	79.5	21.23	73.9	19.88	71.1	19.06	68.8	18.33	64.1	16.86
13.0	11.8	85.1	21.52	79.5	20.52	73.9	18.64	71.1	17.86	68.8	17.21	64.1	15.82	
15.0	13.7	85.1	20.88	79.5	19.35	73.9	17.57	71.1	16.85	68.8	16.22	64.1	14.93	
18.0	16.8	85.1	19.77	79.5	18.42	73.9	16.67	71.1	16.01	68.8	15.33	64.1	14.19	
20.0	18.5	85.1	18.82	79.5	17.59	73.9	15.91	71.1	15.30	68.8	14.57	64.1	13.56	
24.0	20.5	85.1	18.00	79.5	16.92	73.9	15.30	71.1	14.71	68.8	13.92	64.1	13.07	

GMV6 HR DC Inverter VRF Units Technical Sales Guide

TC—Total capacity of outdoor unit; PI—Power input of outdoor unit														
combination	outdoor air temp		indoor air temperature °C DB											
			16		18		20		21		22		24	
	°C DB	°C WB	TC	PI	TC	PI	TC	PI	TC	PI	TC	PI	TC	PI
			kW	kW	kW	kW	kW	kW	kW	kW	kW	kW	kW	kW
120%	-19.8	-20.0	45.4	15.85	44.5	16.50	43.7	16.96	43.4	17.30	43.0	17.67	42.2	18.39
	-18.8	-19.0	45.9	16.06	44.9	16.71	44.2	16.88	43.8	17.48	43.4	17.84	42.7	18.53
	-16.7	-17.0	46.6	16.34	45.8	16.97	45.0	17.25	44.7	17.66	44.3	17.99	43.5	18.63
	-13.7	-15.0	47.5	16.61	46.7	17.18	45.9	17.49	45.6	17.82	45.2	18.12	44.5	18.75
	-11.8	-13.0	48.3	16.86	47.5	17.31	46.7	17.58	46.4	17.87	46.0	18.22	45.3	18.73
	-9.8	-11.0	49.2	17.02	48.4	17.48	47.6	17.64	47.3	17.97	47.0	18.25	46.3	18.83
	-9.5	-10.0	49.6	17.06	48.8	17.50	48.0	17.68	47.7	17.94	47.4	18.08	46.7	18.74
	-8.5	-9.1	50.0	17.11	49.3	17.56	48.5	17.67	48.2	17.97	47.9	18.26	47.2	18.76
	-7.0	-7.6	50.7	17.16	49.9	17.51	49.1	17.65	48.8	17.88	48.5	18.19	47.9	18.58
	-5.0	-5.6	55.2	18.33	54.5	18.75	53.8	18.92	53.5	19.18	53.2	19.41	52.6	19.90
	-3.0	-3.7	56.0	18.29	55.3	18.61	54.6	18.73	54.4	18.96	54.1	19.28	53.4	19.62
	0.0	-0.7	57.3	18.09	56.7	18.38	56.0	18.67	56.1	18.75	55.9	19.04	55.9	19.58
	3.0	2.2	68.3	20.69	67.7	21.08	67.2	21.14	66.4	21.28	60.4	19.59	59.1	19.54
	5.0	4.1	78.4	23.13	73.3	22.16	68.1	20.80	65.6	20.35	63.4	19.94	59.1	18.36
	7.0	6.0	78.5	22.49	73.4	21.45	68.2	20.17	65.7	19.51	63.6	18.78	59.1	17.28
	9.0	7.9	78.6	21.85	73.4	20.86	68.3	19.18	65.7	18.35	63.6	17.67	59.1	16.27
	11.0	9.8	78.6	21.15	73.4	19.90	68.3	18.05	65.7	17.29	63.6	16.63	59.1	15.33
	13.0	11.8	78.6	20.21	73.4	18.67	68.3	16.93	65.7	16.24	63.6	15.64	59.1	14.42
	15.0	13.7	78.6	19.03	73.4	17.58	68.3	15.99	65.7	15.31	63.6	14.76	59.1	13.62
	18.0	16.8	78.6	17.98	73.4	16.65	68.3	15.19	65.7	14.51	63.6	13.98	59.1	12.92
20.0	18.5	78.6	17.04	73.4	15.89	68.3	14.53	65.7	13.84	63.6	13.32	59.1	12.30	
24.0	20.5	78.6	16.21	73.4	15.24	68.3	14.01	65.7	13.27	63.6	12.79	59.1	11.79	
110%	-19.8	-20.0	44.3	16.88	43.5	17.49	42.9	17.84	42.5	18.15	42.2	18.49	41.6	19.17
	-18.8	-19.0	44.7	17.06	44.0	17.57	43.3	17.90	43.0	18.24	42.7	18.64	42.1	19.24
	-16.7	-17.0	45.6	17.29	44.8	17.85	44.2	18.05	43.9	18.45	43.5	18.75	43.0	19.38
	-13.7	-15.0	46.5	17.48	45.8	18.05	45.0	18.23	44.8	18.54	44.5	18.85	44.0	19.45
	-11.8	-13.0	47.3	17.68	46.6	18.10	46.0	18.28	45.6	18.52	45.3	18.89	44.8	19.38
	-9.8	-11.0	48.2	17.74	47.5	18.20	46.9	18.27	46.6	18.62	46.3	18.88	45.8	19.32
	-9.5	-10.0	48.6	17.74	47.9	18.16	47.3	18.31	47.0	18.56	46.7	18.80	46.2	19.29
	-8.5	-9.1	49.1	17.80	48.4	18.21	47.8	18.26	47.5	18.51	47.2	18.83	46.7	19.21
	-7.0	-7.6	49.7	17.80	49.0	18.09	48.4	18.19	48.1	18.43	47.9	18.44	47.3	19.09
	-5.0	-5.6	54.2	18.96	53.7	19.39	53.1	19.50	52.9	19.73	52.6	19.07	52.2	20.47
	-3.0	-3.7	55.1	18.86	54.5	19.15	53.9	19.26	53.7	19.46	55.9	19.06	53.0	20.13
	0.0	-0.7	56.5	18.59	56.1	18.89	55.9	19.07	55.9	19.34	58.2	19.63	54.3	19.30
	3.0	2.2	67.5	21.26	67.1	21.63	63.4	20.59	61.0	20.12	58.6	19.23	54.3	17.57
	5.0	4.1	72.0	21.99	67.2	20.96	62.6	19.46	60.2	18.67	58.2	17.97	54.3	16.54
	7.0	6.0	72.1	21.34	67.3	20.22	62.6	18.31	60.3	17.58	58.2	16.90	54.3	15.56
	9.0	7.9	72.1	20.65	67.4	19.02	62.7	17.26	60.3	16.57	58.2	15.91	54.3	14.67
	11.0	9.8	72.1	19.42	67.4	17.90	62.7	16.25	60.3	15.62	58.2	15.00	54.3	13.85
	13.0	11.8	72.1	18.22	67.4	16.79	62.7	15.28	60.3	14.70	58.2	14.12	54.3	13.04
	15.0	13.7	72.1	17.17	67.4	15.84	62.7	14.44	60.3	13.87	58.2	13.36	54.3	12.34
	18.0	16.8	72.1	16.25	67.4	15.01	62.7	13.18	60.3	13.16	58.2	12.72	54.3	11.75
20.0	18.5	72.1	15.41	67.4	14.28	62.7	12.50	60.3	12.52	58.2	12.20	54.3	11.24	
24.0	20.5	72.1	14.71	67.4	13.62	62.7	11.91	60.3	12.00	58.2	11.75	54.3	10.82	

TC—Total capacity of outdoor unit; PI—Power input of outdoor unit														
combination	outdoor air temp		indoor air temperature °C DB											
			16		18		20		21		22		24	
	°C DB	°C WB	TC kW	PI kW	TC kW	PI kW	TC kW	PI kW	TC kW	PI kW	TC kW	PI kW	TC kW	PI kW
100%	-19.8	-20.0	43.2	17.87	42.5	18.39	41.9	18.54	41.6	18.95	41.3	19.20	40.7	19.84
	-18.8	-19.0	43.6	18.02	42.9	18.44	42.3	18.66	42.1	18.97	41.7	19.32	41.2	19.88
	-16.7	-17.0	44.5	18.17	43.8	18.65	43.2	18.74	42.9	19.03	42.6	19.37	42.0	19.85
	-13.7	-15.0	45.4	18.29	44.8	18.78	44.2	18.84	43.9	19.21	43.4	19.35	42.9	19.93
	-11.8	-13.0	46.2	18.41	45.6	18.76	45.0	18.87	44.7	19.12	44.3	18.63	43.7	19.80
	-9.8	-11.0	47.1	18.39	46.4	18.80	45.9	18.83	45.7	19.07	45.1	19.23	44.6	19.63
	-9.5	-10.0	47.5	18.36	46.9	18.74	46.4	18.76	46.1	19.06	45.5	19.13	45.0	19.60
	-8.5	-9.1	47.9	18.35	47.3	18.65	46.8	18.73	46.5	18.95	45.9	19.09	45.4	19.46
	-7.0	-7.6	48.4	18.26	47.9	18.57	47.3	18.58	47.0	18.79	46.6	18.91	46.6	19.52
	-5.0	-5.6	52.7	19.35	52.1	19.67	51.6	19.67	51.5	19.99	51.2	20.18	49.1	19.86
	-3.0	-3.7	53.5	19.18	52.9	19.40	52.4	19.44	52.3	19.66	52.1	19.88	49.4	18.92
	0.0	-0.7	55.9	19.17	55.9	19.55	55.7	19.67	54.8	19.42	53.0	18.67	49.4	17.21
	3.0	2.2	65.2	21.28	60.8	20.27	56.5	18.30	54.8	17.66	53.0	17.02	49.4	15.66
	5.0	4.1	65.2	20.63	60.8	19.04	56.5	17.22	54.8	16.64	53.0	16.03	49.4	14.78
	7.0	6.0	65.2	19.47	60.8	17.90	56.5	15.86	54.8	15.68	53.0	15.10	49.4	13.93
	9.0	7.9	65.2	18.29	60.8	16.84	56.5	15.18	54.8	14.78	53.0	14.24	49.4	13.15
	11.0	9.8	65.2	17.22	60.8	15.87	56.5	14.33	54.8	13.94	53.0	13.44	49.4	12.43
	13.0	11.8	65.2	16.17	60.8	14.92	56.5	13.51	54.8	13.14	53.0	12.68	49.4	11.73
	15.0	13.7	65.2	15.26	60.8	14.08	56.5	12.77	54.8	12.42	53.0	11.98	49.4	11.11
	18.0	16.8	65.2	14.38	60.8	13.44	56.5	12.35	54.8	11.79	53.0	11.35	49.4	10.58
20.0	18.5	65.2	13.58	60.8	12.90	56.5	11.85	54.8	11.27	53.0	10.82	49.4	10.16	
24.0	20.5	65.2	12.84	60.8	12.47	56.5	11.40	54.8	10.84	53.0	10.40	49.4	9.84	
90%	-19.8	-20.0	42.2	18.86	41.7	19.34	41.2	19.42	41.1	19.85	40.8	20.14	40.4	20.62
	-18.8	-19.0	42.7	18.98	42.2	19.43	41.6	19.53	41.5	19.86	41.4	20.17	40.8	20.71
	-16.7	-17.0	43.5	19.09	43.1	19.58	42.6	19.60	42.4	19.88	42.2	20.26	41.8	20.71
	-13.7	-15.0	44.5	19.18	43.9	19.59	43.5	19.59	43.4	19.79	43.2	20.26	42.7	20.63
	-11.8	-13.0	45.3	19.21	44.9	19.54	44.4	19.60	44.3	19.89	44.0	20.10	43.5	20.53
	-9.8	-11.0	46.2	19.12	45.7	19.42	45.4	19.50	45.2	19.74	45.0	19.98	43.5	19.96
	-9.5	-10.0	46.7	19.09	46.3	19.46	45.8	19.40	45.7	19.74	45.4	19.94	43.9	19.77
	-8.5	-9.1	47.0	19.03	46.6	19.30	46.2	19.36	46.0	19.55	45.8	19.79	44.4	19.66
	-7.0	-7.6	47.6	18.91	47.2	19.16	46.7	19.17	46.6	19.40	46.5	19.62	44.4	18.78
	-5.0	-5.6	52.0	20.01	51.5	20.32	51.1	20.24	49.1	19.76	47.6	19.18	44.4	17.66
	-3.0	-3.7	52.8	19.76	52.3	17.82	51.1	19.49	49.1	18.73	47.6	18.07	44.4	16.65
	0.0	-0.7	55.9	19.88	54.3	17.25	51.1	17.71	49.1	17.03	47.6	16.44	44.4	15.15
	3.0	2.2	58.8	19.35	54.9	17.84	51.1	16.15	49.1	15.55	47.6	15.01	44.4	13.86
	5.0	4.1	58.8	18.20	54.9	16.78	51.1	15.23	49.1	14.65	47.6	14.17	44.4	13.08
	7.0	6.0	58.8	17.11	54.9	15.81	51.1	14.36	49.1	13.83	47.6	13.37	44.4	12.36
	9.0	7.9	58.8	16.13	54.9	14.88	51.1	13.54	49.1	13.06	47.6	12.63	44.4	11.68
	11.0	9.8	58.8	15.19	54.9	14.04	51.1	12.81	49.1	12.35	47.6	11.93	44.4	11.07
	13.0	11.8	58.8	14.29	54.9	13.24	51.1	12.08	49.1	11.65	47.6	11.28	44.4	10.45
	15.0	13.7	58.8	13.51	54.9	12.51	51.1	11.45	49.1	11.00	47.6	10.69	44.4	9.92
	18.0	16.8	58.8	12.77	54.9	11.82	51.1	10.86	49.1	10.39	47.6	10.14	44.4	9.43
20.0	18.5	58.8	12.07	54.9	11.17	51.1	10.32	49.1	9.81	47.6	9.63	44.4	9.01	
24.0	20.5	58.8	11.39	54.9	10.54	51.1	9.79	49.1	9.26	47.6	9.14	44.4	8.61	

GMV6 HR DC Inverter VRF Units Technical Sales Guide

TC—Total capacity of outdoor unit; PI—Power input of outdoor unit														
combination	outdoor air temp		indoor air temperature °C DB											
			16		18		20		21		22		24	
	TC	PI	TC	PI	TC	PI	TC	PI	TC	PI	TC	PI		
	°C DB	°C WB	kW	kW	kW	kW	kW	kW	kW	kW	kW	kW	kW	kW
80%	-19.8	-20.0	41.4	19.85	40.9	20.29	40.5	20.27	40.4	20.58	40.3	20.98	38.5	20.70
	-18.8	-19.0	41.8	19.94	41.4	20.34	41.1	20.41	41.0	20.72	40.8	20.98	38.6	20.57
	-16.7	-17.0	42.8	20.03	42.3	20.43	41.9	20.39	41.8	20.67	41.7	20.93	38.6	20.06
	-13.7	-15.0	43.6	20.01	43.3	20.42	42.9	20.37	42.8	20.62	42.2	20.77	39.0	19.73
	-11.8	-13.0	44.6	20.01	44.1	20.28	43.7	20.27	43.7	20.57	42.2	20.19	39.6	19.06
	-9.8	-11.0	45.4	19.85	45.1	20.13	44.7	20.13	44.1	20.12	42.4	19.56	39.6	18.01
	-9.5	-10.0	45.9	19.75	45.5	20.08	45.1	19.98	44.1	19.81	42.4	19.00	39.6	17.48
	-8.5	-9.1	46.3	19.70	45.9	19.95	45.5	19.91	44.1	19.33	42.4	18.50	39.6	17.02
	-7.0	-7.6	46.9	19.54	46.5	19.77	45.7	19.18	44.0	18.42	42.4	17.68	39.6	16.35
	-5.0	-5.6	51.2	18.39	48.8	19.92	45.4	17.93	43.8	17.23	42.4	16.63	39.6	15.33
	-3.0	-3.7	52.1	18.09	48.8	18.75	45.4	16.90	43.8	16.31	42.4	15.69	39.6	14.49
	0.0	-0.7	52.3	18.47	48.8	17.02	45.4	15.40	43.8	14.82	42.4	14.30	39.6	13.22
	3.0	2.2	52.3	16.83	48.8	15.52	45.4	14.09	43.8	13.54	42.4	13.11	39.6	12.12
	5.0	4.1	52.3	15.85	48.8	14.64	45.4	13.30	43.8	12.79	42.4	12.39	39.6	11.47
	7.0	6.0	52.3	14.93	48.8	13.84	45.4	12.57	43.8	12.10	42.4	11.72	39.6	10.85
	9.0	7.9	52.3	14.10	48.8	13.04	45.4	11.94	43.8	11.43	42.4	11.08	39.6	10.28
	11.0	9.8	52.3	13.31	48.8	12.32	45.4	11.25	43.8	10.83	42.4	10.49	39.6	9.75
	13.0	11.8	52.3	12.54	48.8	11.63	45.4	10.64	43.8	10.24	42.4	9.92	39.6	9.22
	15.0	13.7	52.3	11.86	48.8	11.02	45.4	10.09	43.8	9.71	42.4	9.42	39.6	8.78
	18.0	16.8	52.3	11.32	48.8	10.48	45.4	9.61	43.8	9.23	42.4	8.93	39.6	8.37
20.0	18.5	52.3	10.88	48.8	10.05	45.4	9.19	43.8	8.81	42.4	8.51	39.6	7.99	
24.0	20.5	52.3	10.55	48.8	9.72	45.4	8.81	43.8	8.43	42.4	8.13	39.6	7.65	
70%	-19.8	-20.0	40.6	20.85	40.2	21.25	39.9	21.10	38.3	20.60	36.9	20.14	34.5	19.24
	-18.8	-19.0	41.0	20.93	40.8	21.27	39.9	20.95	38.4	20.45	36.9	19.99	34.5	18.84
	-16.7	-17.0	42.0	20.93	41.6	21.22	40.0	20.46	38.4	19.97	36.9	19.45	34.5	17.98
	-13.7	-15.0	42.9	20.84	42.6	21.25	40.0	19.96	38.5	19.34	37.0	18.54	34.5	17.09
	-11.8	-13.0	43.8	20.79	43.0	20.82	40.0	19.05	38.5	18.35	37.0	17.58	34.5	16.21
	-9.8	-11.0	44.8	20.60	43.1	20.05	40.1	18.05	38.6	17.37	37.1	16.64	34.5	15.35
	-9.5	-10.0	45.2	20.46	43.1	19.48	40.1	17.54	38.6	16.88	37.1	16.19	34.5	14.92
	-8.5	-9.1	45.6	20.34	43.1	18.95	40.1	17.08	38.6	16.44	37.1	15.77	34.5	14.55
	-7.0	-7.6	46.0	19.60	43.0	18.07	40.0	16.32	38.5	15.72	37.0	15.07	34.5	13.93
	-5.0	-5.6	45.7	18.31	42.8	16.90	39.8	15.29	38.3	14.71	37.1	14.21	34.5	13.15
	-3.0	-3.7	45.7	17.24	42.8	15.93	39.8	14.44	38.3	13.90	37.1	13.43	34.5	12.43
	0.0	-0.7	45.7	15.69	42.8	14.59	39.8	13.19	38.3	12.71	37.1	12.30	34.5	11.40
	3.0	2.2	45.7	14.34	42.8	13.30	39.8	12.11	38.3	11.67	37.1	11.29	34.5	10.47
	5.0	4.1	45.7	13.53	42.8	12.54	39.8	11.46	38.3	11.04	37.1	10.70	34.5	9.92
	7.0	6.0	45.7	12.79	42.8	11.87	39.8	10.83	38.3	10.45	37.1	10.13	34.5	9.41
	9.0	7.9	45.7	12.09	42.8	11.22	39.8	10.27	38.3	9.91	37.1	9.60	34.5	8.92
	11.0	9.8	45.7	11.44	42.8	10.62	39.8	9.75	38.3	9.40	37.1	9.12	34.5	8.48
	13.0	11.8	45.7	10.81	42.8	10.06	39.8	9.22	38.3	8.92	37.1	8.63	34.5	8.05
	15.0	13.7	45.7	10.24	42.8	9.54	39.8	8.76	38.3	8.48	37.1	8.21	34.5	7.67
	18.0	16.8	45.7	9.71	42.8	9.06	39.8	8.34	38.3	8.08	37.1	7.83	34.5	7.33
20.0	18.5	45.7	9.26	42.8	8.63	39.8	7.96	38.3	7.72	37.1	7.49	34.5	7.03	
24.0	20.5	45.7	8.84	42.8	8.24	39.8	7.64	38.3	7.41	37.1	7.21	34.5	6.78	

TC—Total capacity of outdoor unit; PI—Power input of outdoor unit														
combination	outdoor air temp		indoor air temperature °C DB											
			16		18		20		21		22		24	
	°C DB	°C WB	TC kW	PI kW	TC kW	PI kW	TC kW	PI kW	TC kW	PI kW	TC kW	PI kW	TC kW	PI kW
60%	-19.8	-20.0	39.3	21.54	36.8	20.59	34.2	18.68	32.9	17.95	31.8	17.32	29.7	15.96
	-18.8	-19.0	39.4	21.37	36.8	20.33	34.2	18.31	33.0	17.60	31.8	16.94	29.7	15.63
	-16.7	-17.0	39.4	20.84	36.8	19.51	34.2	17.51	33.0	16.83	31.8	16.19	29.7	14.96
	-13.7	-15.0	39.5	20.17	36.9	18.57	34.3	16.69	33.1	16.05	31.8	15.42	29.7	14.24
	-11.8	-13.0	39.5	19.10	36.9	17.59	34.3	15.85	33.1	15.24	31.8	14.65	29.7	13.55
	-9.8	-11.0	39.5	18.07	37.0	16.66	34.4	15.04	33.1	14.45	31.8	13.88	29.7	12.85
	-9.5	-10.0	39.6	17.57	37.0	16.21	34.4	14.63	33.1	14.08	31.8	13.50	29.7	12.49
	-8.5	-9.1	39.6	17.10	37.0	15.80	34.4	14.27	33.1	13.73	31.8	13.17	29.7	12.20
	-7.0	-7.6	39.5	16.32	36.9	15.09	34.3	13.64	33.1	13.13	31.8	12.62	29.7	11.71
	-5.0	-5.6	39.3	15.28	36.7	14.13	34.1	12.81	32.9	12.33	31.8	11.93	29.7	11.08
	-3.0	-3.7	39.3	14.43	36.7	13.35	34.1	12.17	32.9	11.68	31.8	11.30	29.7	10.49
	0.0	-0.7	39.3	13.18	36.7	12.23	34.1	11.13	32.9	10.72	31.8	10.37	29.7	9.64
	3.0	2.2	39.3	12.09	36.7	11.23	34.1	10.25	32.9	9.87	31.8	9.57	29.7	8.90
	5.0	4.1	39.3	11.43	36.7	10.62	34.1	9.71	32.9	9.37	31.8	9.07	29.7	8.45
	7.0	6.0	39.3	10.82	36.7	10.06	34.1	9.20	32.9	8.88	31.8	8.63	29.7	8.03
	9.0	7.9	39.3	10.25	36.7	9.54	34.1	8.74	32.9	8.44	31.8	8.18	29.7	7.65
	11.0	9.8	39.3	9.73	36.7	9.06	34.1	8.32	32.9	8.02	31.8	7.78	29.7	7.29
	13.0	11.8	39.3	9.20	36.7	8.59	34.1	7.90	32.9	7.62	31.8	7.40	29.7	6.93
	15.0	13.7	39.3	8.76	36.7	8.15	34.1	7.52	32.9	7.27	31.8	7.06	29.7	6.61
	18.0	16.8	39.3	8.37	36.7	7.76	34.1	7.19	32.9	6.95	31.8	6.77	29.7	6.33
20.0	18.5	39.3	8.02	36.7	7.42	34.1	6.89	32.9	6.68	31.8	6.51	29.7	6.10	
24.0	20.5	39.3	7.71	36.7	7.11	34.1	6.64	32.9	6.45	31.8	6.30	29.7	5.89	
50%	-19.8	-20.0	32.8	18.10	30.6	16.65	28.6	15.00	27.5	14.53	26.4	13.93	24.7	12.92
	-18.8	-19.0	32.9	17.72	30.7	16.32	28.6	14.72	27.5	14.23	26.4	13.65	24.7	12.67
	-16.7	-17.0	32.9	16.92	30.7	15.60	28.6	14.10	27.6	13.64	26.5	13.10	24.7	12.15
	-13.7	-15.0	33.0	16.15	30.8	14.90	28.7	13.47	27.6	13.04	26.5	12.52	24.7	11.60
	-11.8	-13.0	33.0	15.33	30.8	14.18	28.7	12.82	27.6	12.42	26.5	11.91	24.7	11.05
	-9.8	-11.0	33.0	14.54	30.8	13.44	28.7	12.20	27.6	11.81	26.6	11.34	24.7	10.50
	-9.5	-10.0	33.0	14.15	30.8	13.08	28.7	11.89	27.7	11.52	26.6	11.06	24.7	10.23
	-8.5	-9.1	33.0	13.80	30.8	12.77	28.7	11.60	27.7	11.24	26.6	10.80	24.7	9.99
	-7.0	-7.6	33.0	13.20	30.8	12.27	28.7	11.12	27.6	10.78	26.5	10.36	24.7	9.61
	-5.0	-5.6	32.8	12.38	30.6	11.48	28.5	10.47	27.4	10.15	26.5	9.80	24.7	9.11
	-3.0	-3.7	32.8	11.72	30.6	10.88	28.5	9.93	27.4	9.63	26.5	9.29	24.7	8.66
	0.0	-0.7	32.8	10.76	30.6	9.99	28.5	9.16	27.4	8.87	26.5	8.58	24.7	8.01
	3.0	2.2	32.8	9.91	30.6	9.21	28.5	8.45	27.4	8.20	26.5	7.94	24.7	7.41
	5.0	4.1	32.8	9.41	30.6	8.74	28.5	8.03	27.4	7.80	26.5	7.54	24.7	7.05
	7.0	6.0	32.8	8.92	30.6	8.31	28.5	7.65	27.4	7.42	26.5	7.19	24.7	6.73
	9.0	7.9	32.8	8.47	30.6	7.89	28.5	7.28	27.4	7.09	26.5	6.85	24.7	6.42
	11.0	9.8	32.8	8.05	30.6	7.51	28.5	6.94	27.4	6.75	26.5	6.53	24.7	6.12
	13.0	11.8	32.8	7.66	30.6	7.14	28.5	6.60	27.4	6.43	26.5	6.21	24.7	5.84
	15.0	13.7	32.8	7.28	30.6	6.81	28.5	6.31	27.4	6.14	26.5	5.94	24.7	5.57
	18.0	16.8	32.8	6.93	30.6	6.51	28.5	6.06	27.4	5.88	26.5	5.68	24.7	5.31
20.0	18.5	32.8	6.61	30.6	6.23	28.5	5.82	27.4	5.67	26.5	5.45	24.7	5.08	
24.0	20.5	32.8	6.30	30.6	5.97	28.5	5.42	27.4	5.48	26.5	5.24	24.7	4.87	

GMV6 HR DC Inverter VRF Units Technical Sales Guide

GMV-VQ560WM/C-X

TC—Total capacity of outdoor unit; PI—Power input of outdoor unit														
combination	outdoor air temp		indoor air temperature °C DB											
			16		18		20		21		22		24	
	°C DB	°C WB	TC kW	PI kW	TC kW	PI kW	TC kW	PI kW	TC kW	PI kW	TC kW	PI kW	TC kW	PI kW
135%	-19.8	-20.0	48.3	19.07	48.1	20.43	48.0	21.51	47.9	22.20	47.9	23.02	47.7	24.38
	-18.8	-19.0	48.7	19.39	48.6	20.74	48.4	21.66	48.4	22.46	48.3	23.13	48.3	24.61
	-16.7	-17.0	49.6	19.88	49.5	21.18	49.4	22.14	49.3	22.69	49.3	23.45	49.1	24.82
	-13.7	-15.0	50.6	20.37	50.5	21.57	50.3	22.43	50.2	23.03	50.2	23.78	50.1	25.00
	-11.8	-13.0	51.4	20.78	51.4	21.86	51.2	22.62	51.2	23.31	51.1	23.91	51.0	25.10
	-9.8	-11.0	52.4	21.12	52.3	22.16	52.1	22.86	52.1	23.41	52.0	23.96	52.0	25.13
	-9.5	-10.0	52.8	21.21	52.7	22.20	52.6	22.90	52.6	23.44	52.5	24.05	52.4	25.02
	-8.5	-9.1	53.3	21.37	53.2	22.32	53.0	22.87	53.0	23.46	53.0	24.02	52.9	25.07
	-7.0	-7.6	53.9	21.48	53.8	22.32	53.7	22.92	53.7	23.41	53.6	23.97	53.5	24.97
	-5.0	-5.6	56.1	22.01	55.9	22.41	55.8	23.38	55.8	23.89	55.8	24.41	55.6	25.25
	-3.0	-3.7	58.3	22.58	58.1	23.37	58.1	23.81	57.9	24.28	57.9	24.73	57.7	25.57
	0.0	-0.7	62.9	23.67	62.9	24.41	62.7	24.78	62.7	25.20	62.5	25.65	62.5	26.43
	3.0	2.2	67.9	24.65	67.7	25.32	67.5	25.67	67.5	26.06	67.5	26.48	67.3	27.20
	5.0	4.1	71.3	25.27	71.1	25.92	71.1	26.21	70.9	26.59	70.9	26.99	70.7	27.68
	7.0	6.0	74.9	25.86	74.7	26.45	74.7	26.74	74.5	24.19	74.5	27.46	71.5	26.45
	9.0	7.9	78.7	26.40	78.5	26.98	78.5	27.22	78.3	27.58	76.7	27.09	71.5	24.86
	11.0	9.8	82.7	26.93	82.5	27.46	82.1	27.49	79.3	26.48	76.7	25.45	71.5	23.42
	13.0	11.8	87.3	27.51	86.9	27.96	82.4	25.88	79.3	24.82	76.7	23.90	71.5	21.98
15.0	13.7	92.8	28.36	88.6	26.88	82.4	24.39	79.3	23.42	76.7	22.53	71.5	20.75	
18.0	16.8	92.8	26.86	88.6	25.59	82.4	23.14	79.3	22.25	76.7	21.29	71.5	19.71	
20.0	18.5	92.8	25.56	88.6	24.45	82.4	22.09	79.3	21.26	76.7	20.24	71.5	18.83	
24.0	20.5	92.8	24.45	88.6	23.51	82.4	21.24	79.3	20.44	76.7	19.33	71.5	18.15	
120%	-19.8	-20.0	48.0	20.89	48.0	22.19	47.8	23.11	47.8	23.75	47.8	24.48	47.7	25.86
	-18.8	-19.0	48.6	21.20	48.4	22.46	48.3	22.98	48.3	24.01	48.3	24.69	48.1	26.04
	-16.7	-17.0	49.4	21.59	49.4	22.83	49.2	23.50	49.2	24.23	49.1	24.86	49.1	26.17
	-13.7	-15.0	50.5	21.98	50.3	23.07	50.1	23.79	50.2	24.45	50.1	25.04	50.0	26.23
	-11.8	-13.0	51.3	22.28	51.2	23.26	51.1	23.92	51.0	24.49	51.0	25.14	50.9	26.20
	-9.8	-11.0	52.3	22.52	52.1	23.46	52.0	23.96	52.0	24.63	52.0	25.13	51.8	26.23
	-9.5	-10.0	52.7	22.55	52.5	23.48	52.5	24.05	52.4	24.57	52.4	24.87	52.2	26.07
	-8.5	-9.1	53.2	22.66	53.0	23.55	53.0	24.02	52.9	24.59	52.9	25.11	52.7	26.08
	-7.0	-7.6	53.8	22.71	53.7	23.50	53.6	23.97	53.5	24.44	53.5	24.98	53.4	25.85
	-5.0	-5.6	55.9	23.14	55.8	23.93	55.7	24.41	55.7	24.84	55.6	25.29	55.5	26.13
	-3.0	-3.7	58.1	23.65	58.1	24.38	57.9	24.73	57.9	25.15	57.7	25.61	57.7	26.39
	0.0	-0.7	62.7	24.65	62.7	25.33	62.5	25.93	62.5	26.04	62.3	26.44	62.3	27.19
	3.0	2.2	67.7	25.57	67.5	26.18	67.5	26.45	67.3	26.84	67.3	27.21	65.9	27.14
	5.0	4.1	71.1	26.13	70.9	26.72	70.9	26.96	70.7	27.32	70.7	27.69	65.9	25.50
	7.0	6.0	74.7	26.66	74.7	27.22	74.5	27.43	73.3	27.13	70.9	26.08	65.9	24.00
	9.0	7.9	78.5	27.20	78.3	27.72	75.7	26.49	73.3	25.49	70.9	24.53	65.9	22.59
	11.0	9.8	82.5	27.67	81.3	27.45	76.1	25.06	73.3	24.01	70.9	23.10	65.9	21.30
	13.0	11.8	87.2	27.96	81.9	25.94	76.1	23.52	73.3	22.55	70.9	21.73	65.9	20.03
15.0	13.7	87.6	26.45	81.9	24.43	76.1	22.20	73.3	21.27	70.9	20.50	65.9	18.92	
18.0	16.8	87.6	24.99	81.9	23.14	76.1	21.09	73.3	20.16	70.9	19.41	65.9	17.94	
20.0	18.5	87.6	23.68	81.9	22.08	76.1	20.19	73.3	19.23	70.9	18.50	65.9	17.09	
24.0	20.5	87.6	22.53	81.9	21.18	76.1	19.45	73.3	18.44	70.9	17.77	65.9	16.38	

TC—Total capacity of outdoor unit; PI—Power input of outdoor unit														
combination	outdoor air temp		indoor air temperature °C DB											
			16		18		20		21		22		24	
	°C DB	°C WB	TC kW	PI kW	TC kW	PI kW	TC kW	PI kW	TC kW	PI kW	TC kW	PI kW	TC kW	PI kW
110%	-19.8	-20.0	47.9	22.75	47.8	23.95	47.7	24.72	47.7	25.38	47.7	26.00	47.5	27.30
	-18.8	-19.0	48.4	23.02	48.3	24.06	48.2	24.82	48.2	25.43	48.1	26.17	48.1	27.35
	-16.7	-17.0	49.3	23.30	49.2	24.44	49.1	24.99	49.0	25.67	49.1	26.33	48.9	27.50
	-13.7	-15.0	50.3	23.59	50.1	24.62	50.1	25.24	50.0	25.80	50.0	26.36	49.9	27.52
	-11.8	-13.0	51.1	23.82	51.1	24.70	50.9	25.22	50.9	25.73	50.9	26.41	50.8	27.37
	-9.8	-11.0	52.1	23.92	52.0	24.80	51.9	25.21	51.9	25.82	51.8	26.29	51.8	27.21
	-9.5	-10.0	52.5	23.90	52.4	24.73	52.3	25.23	52.3	25.70	52.2	26.16	52.2	27.15
	-8.5	-9.1	53.0	23.96	52.9	24.79	52.8	25.15	52.8	25.61	52.7	26.17	52.7	27.01
	-7.0	-7.6	53.6	23.95	53.6	24.64	53.4	25.02	53.4	25.47	53.4	25.64	53.3	26.80
	-5.0	-5.6	55.8	24.30	55.6	25.03	55.6	25.39	55.5	25.80	57.5	25.96	55.4	27.10
	-3.0	-3.7	57.9	24.71	57.9	25.36	57.7	25.64	57.7	26.05	62.3	26.47	57.5	27.21
	0.0	-0.7	62.5	25.63	62.5	26.24	62.3	26.48	62.3	26.85	64.9	27.26	60.5	26.81
	3.0	2.2	67.5	26.49	67.3	27.04	67.3	27.23	67.1	27.57	64.9	26.53	60.5	24.40
	5.0	4.1	70.9	26.99	70.9	27.55	69.5	26.92	67.1	25.91	64.9	24.96	60.5	22.97
	7.0	6.0	74.5	27.49	73.9	27.66	69.8	25.41	67.1	24.39	64.9	23.47	60.5	21.62
	9.0	7.9	78.3	27.94	75.1	26.44	69.9	23.95	67.2	22.98	64.9	22.10	60.5	20.38
	11.0	9.8	80.5	27.01	75.1	24.87	69.9	22.55	67.2	21.67	64.9	20.84	60.5	19.24
	13.0	11.8	80.5	25.33	75.1	23.33	69.9	21.21	67.2	20.39	64.9	19.61	60.5	18.12
	15.0	13.7	80.5	23.87	75.1	22.01	69.9	20.04	67.2	19.25	64.9	18.55	60.5	17.15
	18.0	16.8	80.5	22.59	75.1	20.86	69.9	18.29	67.2	18.25	64.9	17.67	60.5	16.32
20.0	18.5	80.5	21.43	75.1	19.84	69.9	17.35	67.2	17.38	64.9	16.94	60.5	15.61	
24.0	20.5	80.5	20.46	75.1	18.93	69.9	16.53	67.2	16.64	64.9	16.32	60.5	15.03	
100%	-19.8	-20.0	47.6	24.54	47.5	25.62	47.4	26.12	47.3	26.83	47.2	27.34	47.1	28.60
	-18.8	-19.0	48.1	24.77	47.9	25.67	47.8	26.25	47.8	26.83	47.7	27.53	47.5	28.55
	-16.7	-17.0	49.0	24.95	48.9	25.96	48.7	26.32	48.7	26.91	48.5	27.48	48.4	28.50
	-13.7	-15.0	50.0	25.12	49.8	26.03	49.7	26.39	49.6	27.04	49.4	27.44	49.2	28.48
	-11.8	-13.0	50.8	25.25	50.7	26.00	50.5	26.38	50.6	26.92	50.2	26.30	50.2	28.28
	-9.8	-11.0	51.8	25.23	51.6	26.02	51.5	26.27	51.4	26.74	51.1	27.15	51.0	27.92
	-9.5	-10.0	52.2	25.17	52.1	25.96	51.9	26.15	52.0	26.75	51.5	26.98	51.4	27.85
	-8.5	-9.1	52.6	25.14	52.4	25.77	52.3	26.08	52.3	26.51	51.9	26.89	51.8	27.61
	-7.0	-7.6	53.1	24.98	53.0	25.62	52.8	25.84	52.9	26.31	52.5	26.55	52.5	27.40
	-5.0	-5.6	55.1	25.22	54.9	25.83	54.9	26.06	54.7	26.46	54.7	26.85	54.7	27.59
	-3.0	-3.7	57.7	25.78	57.7	26.36	57.5	26.56	57.5	26.94	57.5	27.32	55.1	26.27
	0.0	-0.7	62.3	26.64	62.3	27.16	62.1	27.31	61.1	26.96	59.1	25.93	55.1	23.90
	3.0	2.2	67.3	27.38	67.1	27.87	63.1	25.45	61.1	24.53	59.1	23.63	55.1	21.76
	5.0	4.1	70.7	27.88	67.1	26.18	63.0	23.91	61.1	23.10	59.1	22.26	55.1	20.52
	7.0	6.0	71.1	26.46	67.1	24.61	63.0	21.26	61.1	21.77	59.1	20.97	55.1	19.35
	9.0	7.9	72.7	25.42	67.8	23.40	63.0	21.07	61.1	20.52	59.1	19.77	55.1	18.26
	11.0	9.8	72.7	23.93	67.8	22.06	63.0	19.90	61.1	19.35	59.1	18.66	55.1	17.26
	13.0	11.8	72.7	22.48	67.8	20.74	63.0	18.76	61.1	18.24	59.1	17.61	55.1	16.29
	15.0	13.7	72.7	21.20	67.8	19.57	63.0	17.72	61.1	17.25	59.1	16.64	55.1	15.43
	18.0	16.8	72.7	19.99	67.8	18.67	63.0	17.15	61.1	16.38	59.1	15.76	55.1	14.70
20.0	18.5	72.7	18.87	67.8	17.92	63.0	16.46	61.1	15.64	59.1	15.03	55.1	14.11	
24.0	20.5	72.7	17.84	67.8	17.32	63.0	15.83	61.1	15.06	59.1	14.44	55.1	13.67	

GMV6 HR DC Inverter VRF Units Technical Sales Guide

TC—Total capacity of outdoor unit; PI—Power input of outdoor unit														
combination	outdoor air temp		indoor air temperature °C DB											
			16		18		20		21		22		24	
	TC	PI	TC	PI	TC	PI	TC	PI	TC	PI	TC	PI	TC	PI
	°C DB	°C WB	kW	kW	kW	kW	kW	kW	kW	kW	kW	kW	kW	kW
90%	-19.8	-20.0	47.4	26.41	47.4	27.42	47.3	27.77	47.3	28.47	47.4	29.10	47.1	29.98
	-18.8	-19.0	48.0	26.60	47.8	27.45	47.8	27.89	47.9	28.51	47.8	29.05	47.7	30.12
	-16.7	-17.0	48.8	26.70	48.8	27.64	48.7	27.92	48.7	28.46	48.7	29.09	48.4	29.91
	-13.7	-15.0	49.8	26.77	49.7	27.60	49.6	27.84	49.6	28.18	49.5	28.90	48.5	29.23
	-11.8	-13.0	50.7	26.76	50.7	27.52	50.6	27.79	50.6	28.28	50.5	28.72	48.5	28.55
	-9.8	-11.0	51.6	26.63	51.5	27.24	51.4	27.52	51.5	28.05	51.5	28.48	48.6	27.76
	-9.5	-10.0	52.1	26.51	52.0	27.27	51.9	27.35	52.0	27.96	51.9	28.38	48.9	27.45
	-8.5	-9.1	52.5	26.46	52.3	27.02	52.3	27.26	52.4	27.72	52.3	28.14	49.5	27.31
	-7.0	-7.6	53.0	26.21	52.9	26.78	52.9	27.02	52.9	27.41	52.8	27.78	49.5	26.08
	-5.0	-5.6	54.9	26.35	54.6	26.85	54.7	27.00	54.6	27.32	53.1	26.64	49.5	24.53
	-3.0	-3.7	57.5	26.85	57.5	24.41	56.9	27.05	54.8	26.00	53.1	25.10	49.5	23.12
	0.0	-0.7	62.3	27.62	60.5	23.96	56.9	24.58	54.8	23.63	53.1	22.82	49.5	21.04
	3.0	2.2	64.1	26.31	60.5	24.50	56.9	22.42	54.8	21.58	53.1	20.84	49.5	19.25
	5.0	4.1	64.6	24.92	61.2	23.32	56.9	21.13	54.8	20.33	53.1	19.67	49.5	18.17
	7.0	6.0	65.5	23.75	61.2	21.97	56.9	19.92	54.8	19.20	53.1	18.56	49.5	17.17
	9.0	7.9	65.5	22.39	61.2	20.68	56.9	18.79	54.8	18.13	53.1	17.54	49.5	16.22
	11.0	9.8	65.5	21.09	61.2	19.51	56.9	17.78	54.8	17.14	53.1	16.57	49.5	15.37
	13.0	11.8	65.5	19.85	61.2	18.40	56.9	16.76	54.8	16.18	53.1	15.66	49.5	14.52
	15.0	13.7	65.5	18.76	61.2	17.38	56.9	15.89	54.8	15.28	53.1	14.84	49.5	13.78
	18.0	16.8	65.5	17.73	61.2	16.42	56.9	15.08	54.8	14.43	53.1	14.08	49.5	13.10
20.0	18.5	65.5	16.76	61.2	15.52	56.9	14.32	54.8	13.62	53.1	13.38	49.5	12.51	
24.0	20.5	65.5	15.82	61.2	14.65	56.9	13.59	54.8	12.86	53.1	12.70	49.5	11.95	
80%	-19.8	-20.0	47.3	28.28	47.2	29.19	47.2	29.37	47.3	29.97	46.9	30.44	43.0	28.75
	-18.8	-19.0	47.8	28.43	47.7	29.17	47.6	29.45	47.7	30.05	47.0	30.08	43.0	28.57
	-16.7	-17.0	48.7	28.42	48.6	29.27	48.6	29.41	48.6	29.90	47.0	29.42	43.1	27.87
	-13.7	-15.0	49.7	28.39	49.5	29.12	49.5	29.23	49.1	29.44	47.1	28.85	43.5	27.40
	-11.8	-13.0	50.5	28.27	50.5	28.91	50.4	29.09	49.1	28.75	47.1	28.04	44.1	26.47
	-9.8	-11.0	51.5	28.03	51.3	28.58	51.0	28.58	49.2	27.93	47.3	27.16	44.1	25.01
	-9.5	-10.0	51.9	27.86	51.9	28.53	51.0	28.11	49.2	27.50	47.3	26.37	44.1	24.28
	-8.5	-9.1	52.3	27.76	52.3	28.31	51.0	27.76	49.2	26.84	47.3	25.68	44.1	23.64
	-7.0	-7.6	52.8	27.45	52.8	27.95	50.9	26.63	49.1	25.57	47.3	24.55	44.1	22.70
	-5.0	-5.6	54.7	24.48	54.5	27.67	50.6	24.90	48.8	23.92	47.3	23.09	44.1	21.29
	-3.0	-3.7	56.9	24.62	54.5	26.05	50.6	23.46	48.8	22.65	47.3	21.79	44.1	20.12
	0.0	-0.7	56.9	25.04	54.5	23.65	50.6	21.39	48.8	20.57	47.3	19.86	44.1	18.36
	3.0	2.2	58.3	23.38	54.5	21.57	50.6	19.57	48.8	18.81	47.3	18.20	44.1	16.84
	5.0	4.1	58.3	22.02	54.5	20.34	50.6	18.47	48.8	17.77	47.3	17.21	44.1	15.93
	7.0	6.0	58.3	20.74	54.5	19.23	50.6	17.45	48.8	16.81	47.3	16.27	44.1	15.07
	9.0	7.9	58.3	19.58	54.5	18.11	50.6	16.58	48.8	15.88	47.3	15.39	44.1	14.28
	11.0	9.8	58.3	18.49	54.5	17.12	50.6	15.62	48.8	15.03	47.3	14.57	44.1	13.54
	13.0	11.8	58.3	17.43	54.5	16.16	50.6	14.78	48.8	14.22	47.3	13.78	44.1	12.81
	15.0	13.7	58.3	16.48	54.5	15.32	50.6	14.02	48.8	13.49	47.3	13.08	44.1	12.19
	18.0	16.8	58.3	15.72	54.5	14.57	50.6	13.35	48.8	12.82	47.3	12.40	44.1	11.63
20.0	18.5	58.3	15.12	54.5	13.96	50.6	12.77	48.8	12.24	47.3	11.81	44.1	11.10	
24.0	20.5	58.3	14.66	54.5	13.51	50.6	12.24	48.8	11.71	47.3	11.29	44.1	10.63	

TC—Total capacity of outdoor unit; PI—Power input of outdoor unit														
combination	outdoor air temp		indoor air temperature °C DB											
			16		18		20		21		22		24	
	°C DB	°C WB	TC kW	PI kW	TC kW	PI kW	TC kW	PI kW	TC kW	PI kW	TC kW	PI kW	TC kW	PI kW
70%	-19.8	-20.0	47.1	30.17	47.1	30.98	44.4	29.25	42.8	28.62	41.1	27.96	38.5	26.71
	-18.8	-19.0	47.7	30.31	47.6	30.96	44.5	29.03	42.8	28.41	41.1	27.75	38.5	26.15
	-16.7	-17.0	48.5	30.15	47.9	30.41	44.5	28.36	42.9	27.75	41.2	27.01	38.5	24.96
	-13.7	-15.0	49.5	30.01	48.0	29.80	44.6	27.68	43.0	26.87	41.3	25.74	38.5	23.73
	-11.8	-13.0	50.3	29.78	48.0	28.93	44.6	26.41	43.0	25.49	41.3	24.41	38.5	22.51
	-9.8	-11.0	51.3	29.44	48.0	27.87	44.7	25.02	43.0	24.14	41.3	23.11	38.5	21.31
	-9.5	-10.0	51.5	29.04	48.1	27.06	44.7	24.31	43.0	23.45	41.4	22.48	38.5	20.72
	-8.5	-9.1	51.5	28.61	48.1	26.34	44.7	23.68	43.0	22.84	41.4	21.90	38.5	20.20
	-7.0	-7.6	51.4	27.27	48.0	25.11	44.6	22.62	43.0	21.84	41.3	20.93	38.5	19.35
	-5.0	-5.6	51.1	25.47	47.7	23.49	44.3	21.20	42.7	20.44	41.3	19.73	38.5	18.27
	-3.0	-3.7	51.1	23.98	47.7	22.14	44.3	20.02	42.7	19.32	41.3	18.65	38.5	17.27
	0.0	-0.7	51.1	21.83	47.7	20.28	44.3	18.29	42.7	17.67	41.3	17.07	38.5	15.83
	3.0	2.2	51.1	19.95	47.7	18.48	44.3	16.79	42.7	16.21	41.3	15.67	38.5	14.54
	5.0	4.1	51.1	18.83	47.7	17.43	44.3	15.90	42.7	15.34	41.3	14.85	38.5	13.77
	7.0	6.0	51.1	17.79	47.7	16.50	44.3	15.03	42.7	14.53	41.3	14.07	38.5	13.07
	9.0	7.9	51.1	16.82	47.7	15.60	44.3	14.24	42.7	13.77	41.3	13.33	38.5	12.39
	11.0	9.8	51.1	15.91	47.7	14.75	44.3	13.52	42.7	13.07	41.3	12.66	38.5	11.77
	13.0	11.8	51.1	15.03	47.7	13.97	44.3	12.79	42.7	12.40	41.3	11.98	38.5	11.18
	15.0	13.7	51.1	14.24	47.7	13.25	44.3	12.15	42.7	11.79	41.3	11.40	38.5	10.65
	18.0	16.8	51.1	13.51	47.7	12.59	44.3	11.57	42.7	11.23	41.3	10.87	38.5	10.18
20.0	18.5	51.1	12.88	47.7	11.99	44.3	11.04	42.7	10.73	41.3	10.40	38.5	9.77	
24.0	20.5	51.1	12.30	47.7	11.45	44.3	10.60	42.7	10.29	41.3	10.02	38.5	9.41	
60%	-19.8	-20.0	43.9	29.93	41.0	28.62	38.1	25.93	36.7	24.88	35.5	24.04	33.1	22.17
	-18.8	-19.0	43.9	29.70	41.0	28.25	38.1	25.41	36.7	24.39	35.5	23.52	33.1	21.70
	-16.7	-17.0	43.9	28.96	41.1	27.12	38.2	24.30	36.7	23.33	35.5	22.48	33.1	20.77
	-13.7	-15.0	44.0	28.03	41.1	25.81	38.3	23.17	36.8	22.25	35.5	21.41	33.1	19.77
	-11.8	-13.0	44.0	26.54	41.1	24.45	38.3	21.99	36.8	21.13	35.5	20.34	33.1	18.81
	-9.8	-11.0	44.1	25.11	41.2	23.15	38.3	20.87	36.9	20.03	35.5	19.27	33.1	17.84
	-9.5	-10.0	44.1	24.41	41.2	22.53	38.3	20.31	36.9	19.52	35.5	18.74	33.1	17.35
	-8.5	-9.1	44.1	23.77	41.2	21.95	38.3	19.81	36.9	19.03	35.5	18.28	33.1	16.94
	-7.0	-7.6	44.0	22.68	41.1	20.97	38.3	18.94	36.8	18.21	35.5	17.52	33.1	16.26
	-5.0	-5.6	43.8	21.24	40.9	19.64	38.0	17.79	36.6	17.10	35.5	16.56	33.1	15.38
	-3.0	-3.7	43.8	20.05	40.9	18.56	38.0	16.90	36.6	16.20	35.5	15.69	33.1	14.56
	0.0	-0.7	43.8	18.32	40.9	16.99	38.0	15.45	36.6	14.87	35.5	14.40	33.1	13.39
	3.0	2.2	43.8	16.80	40.9	15.61	38.0	14.23	36.6	13.69	35.5	13.29	33.1	12.35
	5.0	4.1	43.8	15.89	40.9	14.76	38.0	13.48	36.6	12.99	35.5	12.59	33.1	11.74
	7.0	6.0	43.8	15.04	40.9	13.98	38.0	12.78	36.6	12.32	35.5	11.98	33.1	11.15
	9.0	7.9	43.8	14.24	40.9	13.26	38.0	12.14	36.6	11.71	35.5	11.36	33.1	10.62
	11.0	9.8	43.8	13.51	40.9	12.60	38.0	11.56	36.6	11.13	35.5	10.80	33.1	10.12
	13.0	11.8	43.8	12.78	40.9	11.93	38.0	10.97	36.6	10.58	35.5	10.28	33.1	9.62
	15.0	13.7	43.8	12.18	40.9	11.33	38.0	10.45	36.6	10.08	35.5	9.81	33.1	9.18
	18.0	16.8	43.8	11.63	40.9	10.79	38.0	9.98	36.6	9.64	35.5	9.40	33.1	8.79
20.0	18.5	43.8	11.14	40.9	10.31	38.0	9.57	36.6	9.26	35.5	9.04	33.1	8.47	
24.0	20.5	43.8	10.72	40.9	9.89	38.0	9.22	36.6	8.94	35.5	8.75	33.1	8.17	

GMV6 HR DC Inverter VRF Units Technical Sales Guide

TC—Total capacity of outdoor unit; PI—Power input of outdoor unit														
combination	outdoor air temp		indoor air temperature °C DB											
			16		18		20		21		22		24	
	°C DB	°C WB	TC kW	PI kW	TC kW	PI kW	TC kW	PI kW	TC kW	PI kW	TC kW	PI kW	TC kW	PI kW
50%	-19.8	-20.0	36.6	25.11	34.2	23.14	31.8	20.78	30.6	20.15	29.4	19.34	27.5	17.94
	-18.8	-19.0	36.6	24.59	34.2	22.68	31.8	20.40	30.7	19.74	29.5	18.96	27.5	17.59
	-16.7	-17.0	36.6	23.49	34.2	21.68	31.8	19.54	30.7	18.92	29.5	18.19	27.5	16.86
	-13.7	-15.0	36.7	22.40	34.3	20.70	31.9	18.66	30.8	18.09	29.6	17.39	27.5	16.10
	-11.8	-13.0	36.7	21.28	34.3	19.70	31.9	17.77	30.8	17.22	29.6	16.54	27.5	15.34
	-9.8	-11.0	36.8	20.18	34.4	18.67	32.0	16.90	30.8	16.38	29.6	15.75	27.5	14.58
	-9.5	-10.0	36.8	19.64	34.4	18.17	32.0	16.48	30.8	15.98	29.6	15.35	27.5	14.20
	-8.5	-9.1	36.8	19.15	34.4	17.75	32.0	16.07	30.8	15.60	29.6	15.00	27.5	13.88
	-7.0	-7.6	36.7	18.32	34.3	17.05	31.9	15.41	30.8	14.96	29.6	14.39	27.5	13.35
	-5.0	-5.6	36.5	17.18	34.1	15.96	31.7	14.51	30.6	14.08	29.5	13.60	27.5	12.65
	-3.0	-3.7	36.5	16.27	34.1	15.12	31.7	13.76	30.6	13.36	29.5	12.90	27.5	12.03
	0.0	-0.7	36.5	14.93	34.1	13.88	31.7	12.69	30.6	12.31	29.5	11.91	27.5	11.12
	3.0	2.2	36.5	13.75	34.1	12.80	31.7	11.71	30.6	11.38	29.5	11.03	27.5	10.29
	5.0	4.1	36.5	13.05	34.1	12.14	31.7	11.13	30.6	10.83	29.5	10.47	27.5	9.79
	7.0	6.0	36.5	12.38	34.1	11.54	31.7	10.61	30.6	10.30	29.5	9.98	27.5	9.35
	9.0	7.9	36.5	11.75	34.1	10.97	31.7	10.09	30.6	9.83	29.5	9.51	27.5	8.91
	11.0	9.8	36.5	11.17	34.1	10.43	31.7	9.62	30.6	9.36	29.5	9.07	27.5	8.50
13.0	11.8	36.5	10.62	34.1	9.92	31.7	9.15	30.6	8.92	29.5	8.63	27.5	8.11	
15.0	13.7	36.5	10.11	34.1	9.47	31.7	8.75	30.6	8.51	29.5	8.25	27.5	7.73	
18.0	16.8	36.5	9.62	34.1	9.05	31.7	8.40	30.6	8.16	29.5	7.89	27.5	7.38	
20.0	18.5	36.5	9.17	34.1	8.66	31.7	8.08	30.6	7.87	29.5	7.57	27.5	7.05	
24.0	20.5	36.5	8.74	34.1	8.30	31.7	7.52	30.6	7.60	29.5	7.28	27.5	6.76	

GMV-VQ615WM/C-X

TC—Total capacity of outdoor unit; PI—Power input of outdoor unit														
combination	outdoor air temp		indoor air temperature °C DB											
			16		18		20		21		22		24	
	°C DB	°C WB	TC kW	PI kW	TC kW	PI kW	TC kW	PI kW	TC kW	PI kW	TC kW	PI kW	TC kW	PI kW
135%	-19.8	-20.0	48.5	19.89	48.4	21.35	48.3	22.46	48.2	23.19	48.2	24.05	48.0	25.47
	-18.8	-19.0	48.9	20.22	48.8	21.63	48.6	22.58	48.6	23.41	48.5	24.11	48.4	25.60
	-16.7	-17.0	49.7	20.69	49.5	21.99	49.5	23.02	49.4	23.60	49.4	24.39	49.2	25.82
	-13.7	-15.0	50.6	21.16	50.6	22.44	50.4	23.32	50.3	23.95	50.3	24.74	50.1	25.95
	-11.8	-13.0	51.5	21.62	51.5	22.75	51.3	23.52	51.3	24.24	51.2	24.87	51.1	26.10
	-9.8	-11.0	53.5	22.41	53.3	23.48	53.1	24.18	53.1	24.78	53.1	25.40	52.9	26.55
	-9.5	-10.0	54.9	22.88	54.6	23.92	54.4	24.58	54.4	25.18	54.2	25.77	54.2	26.89
	-8.5	-9.1	56.0	23.28	55.7	24.29	55.7	24.95	55.5	25.52	55.5	26.10	55.3	27.22
	-7.0	-7.6	57.9	23.96	57.9	24.96	57.7	25.55	57.7	26.12	57.5	26.67	57.3	27.76
	-5.0	-5.6	61.0	24.87	60.8	25.30	60.6	26.35	60.6	26.89	60.3	27.41	60.3	28.43
	-3.0	-3.7	63.8	25.67	63.7	26.61	63.6	27.05	63.4	27.60	63.4	28.12	63.2	29.07
	0.0	-0.7	68.9	26.92	68.9	27.76	68.7	28.16	68.7	28.64	68.4	29.16	68.4	30.05
	3.0	2.2	75.1	28.31	74.8	29.06	74.1	29.25	74.0	29.65	73.9	30.10	73.7	30.93
	5.0	4.1	78.8	29.00	78.5	29.71	78.2	29.91	77.8	30.29	77.7	30.70	77.4	31.47
	7.0	6.0	82.7	29.65	82.3	30.26	81.9	30.43	81.7	30.74	81.7	31.27	81.3	32.07
	9.0	7.9	86.7	30.20	86.0	30.70	86.0	30.95	85.9	31.40	84.0	30.79	84.0	31.63
	11.0	9.8	90.7	30.67	90.5	31.27	90.2	31.37	86.9	30.12	84.0	28.94	84.0	30.63
13.0	11.8	95.5	31.23	95.3	31.84	90.2	29.42	86.9	28.23	84.0	27.17	84.0	29.43	
15.0	13.7	100.1	31.77	95.7	30.14	90.2	27.73	86.9	26.64	84.0	25.61	84.0	28.43	
18.0	16.8	100.1	30.08	95.7	28.69	90.2	26.30	86.9	25.31	84.0	24.21	84.0	27.43	
20.0	18.5	100.1	28.63	95.7	27.41	90.2	25.11	86.9	24.18	84.0	23.01	84.0	26.43	
24.0	20.5	100.1	27.38	95.7	26.36	90.2	24.15	86.9	23.25	84.0	21.98	84.0	25.43	

TC—Total capacity of outdoor unit; PI—Power input of outdoor unit														
combination	outdoor air temp		indoor air temperature °C DB											
			16		18		20		21		22		24	
	°C DB	°C WB	TC kW	PI kW	TC kW	PI kW	TC kW	PI kW	TC kW	PI kW	TC kW	PI kW	TC kW	PI kW
120%	-19.8	-20.0	48.3	21.83	48.3	23.19	48.1	24.13	48.1	24.80	48.0	25.51	47.9	26.96
	-18.8	-19.0	48.8	22.11	48.6	23.41	48.5	23.95	48.4	24.97	48.4	25.68	48.3	27.14
	-16.7	-17.0	49.5	22.46	49.4	23.70	49.3	24.43	49.3	25.20	49.2	25.86	49.1	27.16
	-13.7	-15.0	50.5	22.82	50.4	24.01	50.2	24.74	50.2	25.38	50.1	25.99	50.0	27.23
	-11.8	-13.0	51.4	23.18	51.3	24.20	51.2	24.87	51.1	25.46	51.1	26.14	50.9	27.20
	-9.8	-11.0	53.3	23.86	53.1	24.83	53.1	25.42	52.9	26.00	52.9	26.55	52.7	27.68
	-9.5	-10.0	54.6	24.30	54.4	25.27	54.2	25.78	54.2	26.37	54.2	26.72	54.0	27.98
	-8.5	-9.1	55.7	24.67	55.5	25.60	55.5	26.12	55.3	26.67	55.3	27.26	55.1	28.29
	-7.0	-7.6	57.7	25.31	57.7	26.21	57.5	26.69	57.5	27.24	57.3	27.76	57.3	28.76
	-5.0	-5.6	60.8	26.11	60.6	26.98	60.3	27.43	60.3	27.94	60.3	28.47	60.1	29.40
	-3.0	-3.7	63.6	26.89	63.6	27.72	63.4	28.10	63.4	28.59	63.2	29.11	63.2	30.01
	0.0	-0.7	68.7	28.03	68.7	28.80	68.4	29.47	68.4	29.60	68.2	30.05	68.2	30.92
	3.0	2.2	74.7	29.30	74.5	30.01	73.9	30.06	73.7	30.51	73.7	30.93	72.2	30.86
	5.0	4.1	78.6	30.00	78.4	30.68	77.6	30.64	77.4	31.05	77.4	31.48	72.2	28.99
	7.0	6.0	82.5	30.58	81.9	30.99	81.6	31.18	80.2	30.79	77.6	29.65	72.2	27.29
	9.0	7.9	86.5	31.12	85.8	31.54	83.4	30.28	80.2	28.97	77.6	27.89	72.2	25.69
	11.0	9.8	90.5	31.52	88.2	30.93	83.4	28.49	80.2	27.29	77.6	26.26	72.2	24.22
	13.0	11.8	93.7	31.18	88.2	29.01	83.4	26.74	80.2	25.63	77.6	24.70	72.2	22.78
	15.0	13.7	93.7	29.36	88.2	27.33	83.4	25.24	80.2	24.17	77.6	23.30	72.2	21.51
	18.0	16.8	93.7	27.74	88.2	25.88	83.4	23.98	80.2	22.91	77.6	22.07	72.2	20.40
20.0	18.5	93.7	26.29	88.2	24.70	83.4	22.95	80.2	21.85	77.6	21.04	72.2	19.43	
24.0	20.5	93.7	25.01	88.2	23.69	83.4	22.12	80.2	20.96	77.6	20.20	72.2	18.63	
110%	-19.8	-20.0	48.2	23.80	48.0	24.98	48.0	25.81	47.9	26.45	47.9	27.10	47.8	28.52
	-18.8	-19.0	48.6	24.01	48.5	25.08	48.3	25.81	48.4	26.50	48.3	27.28	48.2	28.46
	-16.7	-17.0	49.4	24.25	49.2	25.38	49.2	25.98	49.1	26.70	49.1	27.33	49.0	28.61
	-13.7	-15.0	50.3	24.49	50.2	25.62	50.1	26.19	50.0	26.77	50.0	27.36	49.9	28.57
	-11.8	-13.0	51.2	24.78	51.1	25.65	51.0	26.22	51.0	26.75	50.9	27.41	50.9	28.47
	-9.8	-11.0	53.1	25.31	52.9	26.21	52.9	26.65	52.7	27.21	52.7	27.74	52.7	28.74
	-9.5	-10.0	54.4	25.71	54.2	26.58	54.0	27.02	54.0	27.55	54.0	28.08	53.8	29.05
	-8.5	-9.1	55.5	26.05	55.3	26.92	55.3	27.32	55.3	27.85	55.1	28.38	55.1	29.32
	-7.0	-7.6	57.5	26.66	57.5	27.46	57.3	27.83	57.3	28.35	57.9	28.86	57.1	29.79
	-5.0	-5.6	60.6	27.40	60.3	28.20	60.1	28.50	60.1	28.99	63.0	29.50	59.9	30.40
	-3.0	-3.7	63.4	28.10	63.4	28.83	63.2	29.14	63.2	29.60	68.2	30.09	63.0	30.94
	0.0	-0.7	68.4	29.15	68.4	29.84	68.2	30.09	68.2	30.52	71.1	30.99	66.3	30.48
	3.0	2.2	74.8	30.48	74.2	30.96	74.0	31.07	73.8	31.47	71.1	30.16	66.3	27.75
	5.0	4.1	78.5	31.03	78.2	31.55	76.4	30.69	73.5	29.47	71.1	28.37	66.3	26.11
	7.0	6.0	82.2	31.50	81.6	31.72	76.4	28.88	73.6	27.75	71.1	26.68	66.3	24.58
	9.0	7.9	86.3	31.97	81.6	29.82	76.5	27.23	73.7	26.15	71.1	25.12	66.3	23.17
	11.0	9.8	86.3	30.07	81.6	28.05	76.5	25.64	73.7	24.66	71.1	23.69	66.3	21.87
	13.0	11.8	86.3	28.21	81.6	26.32	76.5	24.11	73.7	23.20	71.1	22.29	66.3	20.60
	15.0	13.7	86.3	26.58	81.6	24.82	76.5	22.79	73.7	21.90	71.1	21.09	66.3	19.49
	18.0	16.8	86.3	25.15	81.6	23.53	76.5	20.79	73.7	20.77	71.1	20.09	66.3	18.56
20.0	18.5	86.3	23.87	81.6	22.38	76.5	19.73	73.7	19.77	71.1	19.26	66.3	17.75	
24.0	20.5	86.3	22.78	81.6	21.36	76.5	18.80	73.7	18.94	71.1	18.56	66.3	17.08	

GMV6 HR DC Inverter VRF Units Technical Sales Guide

TC—Total capacity of outdoor unit; PI—Power input of outdoor unit														
combination	outdoor air temp		indoor air temperature °C DB											
			16		18		20		21		22		24	
	°C DB	°C WB	TC kW	PI kW	TC kW	PI kW	TC kW	PI kW	TC kW	PI kW	TC kW	PI kW	TC kW	PI kW
100%	-19.8	-20.0	47.9	25.65	47.7	26.72	47.6	27.22	47.5	27.97	47.5	28.56	47.3	29.82
	-18.8	-19.0	48.2	25.78	48.1	26.77	47.9	27.30	48.0	27.96	47.8	28.64	47.7	29.77
	-16.7	-17.0	49.1	25.96	48.9	26.96	48.8	27.36	48.7	27.93	48.5	28.52	48.4	29.59
	-13.7	-15.0	50.0	26.09	49.8	27.03	49.7	27.39	49.6	28.06	49.4	28.48	49.2	29.56
	-11.8	-13.0	50.9	26.27	50.7	27.00	50.6	27.43	50.6	27.94	50.3	27.35	50.2	29.36
	-9.8	-11.0	52.9	26.76	52.7	27.59	52.7	27.89	52.7	28.42	52.5	28.93	52.5	29.84
	-9.5	-10.0	54.2	27.13	54.0	27.93	54.0	28.22	53.8	28.72	53.8	29.23	53.5	30.14
	-8.5	-9.1	55.3	27.43	55.3	28.23	55.1	28.49	55.1	28.99	54.9	29.50	54.9	30.38
	-7.0	-7.6	57.3	27.97	57.3	28.74	57.1	28.97	57.1	29.47	57.1	29.94	56.8	30.82
	-5.0	-5.6	60.3	28.68	60.1	29.37	60.1	29.61	59.9	30.08	59.9	30.52	59.9	31.36
	-3.0	-3.7	63.2	29.32	63.2	29.98	63.0	30.19	63.0	30.62	63.0	31.06	60.3	29.86
	0.0	-0.7	68.2	30.29	68.2	30.89	68.0	31.04	66.9	30.64	64.7	29.48	60.3	27.17
	3.0	2.2	74.1	31.30	73.9	31.88	69.1	28.92	66.9	27.88	64.7	26.86	60.3	24.73
	5.0	4.1	78.2	32.02	74.3	30.11	69.0	27.18	66.9	26.26	64.7	25.30	60.3	23.33
	7.0	6.0	79.6	30.76	74.3	28.30	69.0	23.42	66.9	24.74	64.7	23.84	60.3	22.00
	9.0	7.9	79.6	28.90	74.3	26.63	69.0	23.94	66.9	23.32	64.7	22.48	60.3	20.76
	11.0	9.8	79.6	27.21	74.3	25.10	69.0	22.62	66.9	22.00	64.7	21.22	60.3	19.62
	13.0	11.8	79.6	25.55	74.3	23.60	69.0	21.32	66.9	20.74	64.7	20.02	60.3	18.52
	15.0	13.7	79.6	24.11	74.3	22.27	69.0	20.14	66.9	19.61	64.7	18.92	60.3	17.55
	18.0	16.8	79.6	22.73	74.3	21.25	69.0	19.49	66.9	18.62	64.7	17.92	60.3	16.71
20.0	18.5	79.6	21.45	74.3	20.40	69.0	18.71	66.9	17.79	64.7	17.08	60.3	16.04	
24.0	20.5	79.6	20.28	74.3	19.71	69.0	17.99	66.9	17.12	64.7	16.42	60.3	15.54	
90%	-19.8	-20.0	47.7	27.60	47.6	28.59	47.5	28.93	47.5	29.67	47.6	30.33	47.3	31.25
	-18.8	-19.0	48.1	27.68	48.0	28.62	48.0	29.06	48.0	29.65	47.9	30.21	47.8	31.34
	-16.7	-17.0	48.9	27.78	48.8	28.71	48.7	28.97	48.7	29.54	48.8	30.26	48.5	31.11
	-13.7	-15.0	49.8	27.80	49.7	28.66	49.6	28.88	49.6	29.27	49.7	30.11	49.5	30.98
	-11.8	-13.0	50.8	27.84	50.7	28.58	50.6	28.83	50.6	29.35	50.6	29.87	50.4	30.81
	-9.8	-11.0	52.7	28.21	52.7	28.94	52.5	29.12	52.5	29.63	52.5	30.11	52.2	30.97
	-9.5	-10.0	54.0	28.55	53.8	29.28	53.8	29.42	53.5	29.90	53.5	30.38	53.5	31.21
	-8.5	-9.1	55.1	28.85	55.1	29.54	54.9	29.69	54.9	30.14	54.9	30.62	54.2	31.04
	-7.0	-7.6	57.1	29.32	57.1	29.98	56.8	30.13	56.8	30.58	56.8	31.03	54.2	29.65
	-5.0	-5.6	60.1	29.96	59.9	30.59	59.9	30.68	59.9	31.12	58.1	30.28	54.2	27.88
	-3.0	-3.7	63.0	30.53	63.0	27.76	62.3	30.73	60.1	29.62	58.1	28.53	54.2	26.29
	0.0	-0.7	68.2	31.40	66.3	27.25	62.3	27.93	60.1	26.92	58.1	25.95	54.2	23.92
	3.0	2.2	71.8	30.59	67.0	28.19	62.3	25.47	60.1	24.59	58.1	23.69	54.2	21.89
	5.0	4.1	71.8	28.77	67.0	26.51	62.3	24.02	60.1	23.17	58.1	22.36	54.2	20.65
	7.0	6.0	71.8	27.04	67.0	24.98	62.3	22.64	60.1	21.88	58.1	21.10	54.2	19.52
	9.0	7.9	71.8	25.49	67.0	23.51	62.3	21.36	60.1	20.66	58.1	19.94	54.2	18.45
	11.0	9.8	71.8	24.01	67.0	22.18	62.3	20.21	60.1	19.53	58.1	18.84	54.2	17.48
	13.0	11.8	71.8	22.59	67.0	20.92	62.3	19.06	60.1	18.44	58.1	17.81	54.2	16.51
	15.0	13.7	71.8	21.35	67.0	19.76	62.3	18.06	60.1	17.41	58.1	16.88	54.2	15.67
	18.0	16.8	71.8	20.18	67.0	18.67	62.3	17.14	60.1	16.45	58.1	16.01	54.2	14.90
20.0	18.5	71.8	19.08	67.0	17.65	62.3	16.28	60.1	15.51	58.1	15.21	54.2	14.23	
24.0	20.5	71.8	18.01	67.0	16.66	62.3	15.45	60.1	14.65	58.1	14.44	54.2	13.59	

TC—Total capacity of outdoor unit; PI—Power input of outdoor unit														
combination	outdoor air temp		indoor air temperature °C DB											
			16		18		20		21		22		24	
	°C DB	°C WB	TC kW	PI kW	TC kW	PI kW	TC kW	PI kW	TC kW	PI kW	TC kW	PI kW	TC kW	PI kW
80%	-19.8	-20.0	47.6	29.56	47.4	30.44	47.4	30.60	47.5	31.23	47.4	31.93	47.1	32.72
	-18.8	-19.0	47.9	29.59	47.9	30.42	47.8	30.69	47.8	31.25	47.8	31.75	47.2	32.51
	-16.7	-17.0	48.7	29.51	48.6	30.40	48.6	30.51	48.6	31.03	48.6	31.59	47.2	31.72
	-13.7	-15.0	49.7	29.48	49.5	30.24	49.5	30.33	49.6	30.86	49.5	31.49	47.6	31.15
	-11.8	-13.0	50.6	29.41	50.5	30.02	50.4	30.18	50.5	30.70	50.4	31.17	48.3	30.09
	-9.8	-11.0	52.5	29.66	52.5	30.32	52.2	30.38	52.2	30.80	51.8	30.87	48.3	28.43
	-9.5	-10.0	53.8	29.96	53.5	30.59	53.5	30.62	53.5	31.07	51.8	29.98	48.3	27.60
	-8.5	-9.1	54.9	30.23	54.9	30.86	54.6	30.86	53.5	30.32	51.8	29.19	48.3	26.87
	-7.0	-7.6	56.8	30.67	56.8	31.26	55.3	30.02	53.5	28.95	51.8	27.90	48.3	25.80
	-5.0	-5.6	59.9	27.83	58.8	31.03	55.4	28.30	53.5	27.25	51.8	26.25	48.3	24.21
	-3.0	-3.7	62.3	28.00	58.8	29.21	55.4	26.67	53.5	25.80	51.8	24.76	48.3	22.88
	0.0	-0.7	62.3	28.47	58.8	26.51	55.4	24.31	53.5	23.44	51.8	22.58	48.3	20.88
	3.0	2.2	63.8	26.58	59.6	24.50	55.4	22.24	53.5	21.43	51.8	20.69	48.3	19.14
	5.0	4.1	63.8	25.02	59.6	23.10	55.4	20.99	53.5	20.24	51.8	19.56	48.3	18.11
	7.0	6.0	63.8	23.57	59.6	21.84	55.4	19.84	53.5	19.15	51.8	18.50	48.3	17.14
	9.0	7.9	63.8	22.26	59.6	20.58	55.4	18.85	53.5	18.09	51.8	17.50	48.3	16.23
	11.0	9.8	63.8	21.02	59.6	19.45	55.4	17.76	53.5	17.13	51.8	16.57	48.3	15.40
	13.0	11.8	63.8	19.81	59.6	18.36	55.4	16.80	53.5	16.20	51.8	15.67	48.3	14.56
	15.0	13.7	63.8	18.74	59.6	17.40	55.4	15.94	53.5	15.37	51.8	14.87	48.3	13.86
	18.0	16.8	63.8	17.87	59.6	16.55	55.4	15.18	53.5	14.61	51.8	14.10	48.3	13.22
20.0	18.5	63.8	17.18	59.6	15.86	55.4	14.51	53.5	13.94	51.8	13.43	48.3	12.62	
24.0	20.5	63.8	16.66	59.6	15.35	55.4	13.92	53.5	13.34	51.8	12.83	48.3	12.08	
70%	-19.8	-20.0	47.3	31.46	47.3	32.30	47.2	32.27	46.8	32.50	45.0	31.80	42.2	30.36
	-18.8	-19.0	47.8	31.54	47.7	32.22	47.7	32.31	46.9	32.26	45.1	31.57	42.2	29.73
	-16.7	-17.0	48.5	31.31	48.5	31.97	48.4	32.03	46.9	31.51	45.1	30.72	42.2	28.37
	-13.7	-15.0	49.6	31.20	49.4	31.86	48.8	31.45	47.0	29.72	45.2	29.27	42.2	26.98
	-11.8	-13.0	50.3	30.93	50.3	31.49	48.8	30.02	47.0	28.95	45.2	27.76	42.2	25.58
	-9.8	-11.0	52.2	31.11	51.6	31.06	48.9	28.43	47.1	27.41	45.3	26.29	42.2	24.22
	-9.5	-10.0	53.5	31.38	51.9	30.35	48.9	27.63	47.1	26.64	45.3	25.57	42.2	23.56
	-8.5	-9.1	54.6	31.55	52.4	29.82	48.9	26.91	47.1	25.94	45.3	24.91	42.2	22.96
	-7.0	-7.6	54.6	30.13	52.5	28.54	48.8	25.71	47.0	24.81	45.2	23.81	42.2	22.00
	-5.0	-5.6	55.9	28.94	52.2	26.70	48.5	24.09	46.7	23.22	45.2	22.42	42.2	20.76
	-3.0	-3.7	55.9	27.25	52.2	25.17	48.5	22.76	46.7	21.94	45.2	21.20	42.2	19.63
	0.0	-0.7	55.9	24.81	52.2	23.05	48.5	20.79	46.7	20.07	45.2	19.41	42.2	18.00
	3.0	2.2	55.9	22.67	52.2	21.01	48.5	19.09	46.7	18.42	45.2	17.82	42.2	16.53
	5.0	4.1	55.9	21.39	52.2	19.81	48.5	18.07	46.7	17.43	45.2	16.89	42.2	15.66
	7.0	6.0	55.9	20.22	52.2	18.75	48.5	17.08	46.7	16.50	45.2	15.99	42.2	14.86
	9.0	7.9	55.9	19.12	52.2	17.73	48.5	16.19	46.7	15.64	45.2	15.16	42.2	14.09
	11.0	9.8	55.9	18.08	52.2	16.77	48.5	15.37	46.7	14.85	45.2	14.39	42.2	13.38
	13.0	11.8	55.9	17.08	52.2	15.89	48.5	14.54	46.7	14.09	45.2	13.62	42.2	12.71
	15.0	13.7	55.9	16.18	52.2	15.07	48.5	13.81	46.7	13.39	45.2	12.96	42.2	12.11
	18.0	16.8	55.9	15.36	52.2	14.31	48.5	13.15	46.7	12.76	45.2	12.36	42.2	11.58
20.0	18.5	55.9	14.63	52.2	13.63	48.5	12.55	46.7	12.19	45.2	11.82	42.2	11.11	
24.0	20.5	55.9	13.98	52.2	13.02	48.5	12.06	46.7	11.69	45.2	11.39	42.2	10.70	

GMV6 HR DC Inverter VRF Units Technical Sales Guide

TC—Total capacity of outdoor unit; PI—Power input of outdoor unit														
combination	outdoor air temp		indoor air temperature °C DB											
			16		18		20		21		22		24	
	°C DB	°C WB	TC kW	PI kW	TC kW	PI kW	TC kW	PI kW	TC kW	PI kW	TC kW	PI kW	TC kW	PI kW
60%	-19.8	-20.0	47.2	33.43	44.9	32.56	41.7	29.46	40.2	28.31	38.9	27.32	36.2	25.19
	-18.8	-19.0	47.6	33.46	45.0	32.15	41.8	28.88	40.2	27.75	38.9	26.73	36.2	24.66
	-16.7	-17.0	48.2	32.97	45.0	30.86	41.8	27.61	40.3	26.54	38.9	25.55	36.2	23.60
	-13.7	-15.0	48.3	31.92	45.1	29.37	41.9	26.33	40.4	25.32	38.9	24.33	36.2	22.47
	-11.8	-13.0	48.3	30.21	45.1	27.82	41.9	24.99	40.4	24.04	38.9	23.11	36.2	21.38
	-9.8	-11.0	48.3	28.58	45.2	26.34	42.0	23.72	40.4	22.80	38.9	21.90	36.2	20.28
	-9.5	-10.0	48.4	27.79	45.2	25.63	42.0	23.08	40.4	22.22	38.9	21.30	36.2	19.72
	-8.5	-9.1	48.4	27.06	45.2	24.98	42.0	22.52	40.4	21.66	38.9	20.77	36.2	19.25
	-7.0	-7.6	48.3	25.82	45.1	23.86	41.9	21.52	40.4	20.72	38.9	19.92	36.2	18.48
	-5.0	-5.6	48.0	24.18	44.8	22.35	41.6	20.22	40.1	19.46	38.9	18.82	36.2	17.49
	-3.0	-3.7	48.0	22.83	44.8	21.12	41.6	19.20	40.1	18.44	38.9	17.83	36.2	16.55
	0.0	-0.7	48.0	20.86	44.8	19.33	41.6	17.56	40.1	16.93	38.9	16.37	36.2	15.22
	3.0	2.2	48.0	19.13	44.8	17.76	41.6	16.18	40.1	15.58	38.9	15.11	36.2	14.04
	5.0	4.1	48.0	18.09	44.8	16.80	41.6	15.32	40.1	14.78	38.9	14.31	36.2	13.35
	7.0	6.0	48.0	17.12	44.8	15.91	41.6	14.53	40.1	14.02	38.9	13.61	36.2	12.68
	9.0	7.9	48.0	16.22	44.8	15.09	41.6	13.80	40.1	13.33	38.9	12.92	36.2	12.07
	11.0	9.8	48.0	15.39	44.8	14.33	41.6	13.14	40.1	12.67	38.9	12.28	36.2	11.51
	13.0	11.8	48.0	14.55	44.8	13.58	41.6	12.48	40.1	12.04	38.9	11.68	36.2	10.94
	15.0	13.7	48.0	13.86	44.8	12.89	41.6	11.88	40.1	11.47	38.9	11.15	36.2	10.43
	18.0	16.8	48.0	13.24	44.8	12.28	41.6	11.35	40.1	10.98	38.9	10.68	36.2	10.00
20.0	18.5	48.0	12.68	44.8	11.73	41.6	10.88	40.1	10.54	38.9	10.28	36.2	9.63	
24.0	20.5	48.0	12.20	44.8	11.25	41.6	10.48	40.1	10.18	38.9	9.95	36.2	9.29	
50%	-19.8	-20.0	40.1	28.59	37.5	26.37	34.8	23.61	33.6	22.91	32.2	21.94	30.1	20.39
	-18.8	-19.0	40.1	27.99	37.5	25.85	34.8	23.18	33.6	22.45	32.2	21.50	30.1	19.99
	-16.7	-17.0	40.2	26.74	37.6	24.71	34.9	22.20	33.6	21.52	32.2	20.63	30.1	19.16
	-13.7	-15.0	40.2	25.51	37.6	23.59	34.9	21.20	33.7	20.57	32.3	19.72	30.1	18.30
	-11.8	-13.0	40.2	24.22	37.6	22.45	34.9	20.19	33.7	19.59	32.3	18.77	30.1	17.44
	-9.8	-11.0	40.3	22.97	37.7	21.28	35.0	19.21	33.7	18.62	32.4	17.87	30.1	16.57
	-9.5	-10.0	40.3	22.36	37.7	20.70	35.0	18.73	33.8	18.17	32.4	17.41	30.1	16.14
	-8.5	-9.1	40.3	21.80	37.7	20.22	35.0	18.27	33.8	17.74	32.4	17.02	30.1	15.77
	-7.0	-7.6	40.2	20.85	37.6	19.42	34.9	17.51	33.7	17.01	32.3	16.32	30.1	15.17
	-5.0	-5.6	40.0	19.56	37.4	18.18	34.7	16.49	33.5	16.02	32.3	15.46	30.1	14.37
	-3.0	-3.7	40.0	18.52	37.4	17.22	34.7	15.64	33.5	15.19	32.3	14.66	30.1	13.67
	0.0	-0.7	40.0	17.00	37.4	15.82	34.7	14.43	33.5	14.00	32.3	13.53	30.1	12.64
	3.0	2.2	40.0	15.65	37.4	14.59	34.7	13.31	33.5	12.94	32.3	12.54	30.1	11.70
	5.0	4.1	40.0	14.86	37.4	13.84	34.7	12.65	33.5	12.31	32.3	11.91	30.1	11.13
	7.0	6.0	40.0	14.10	37.4	13.15	34.7	12.06	33.5	11.71	32.3	11.34	30.1	10.63
	9.0	7.9	40.0	13.37	37.4	12.50	34.7	11.47	33.5	11.18	32.3	10.81	30.1	10.13
	11.0	9.8	40.0	12.72	37.4	11.89	34.7	10.94	33.5	10.65	32.3	10.31	30.1	9.66
	13.0	11.8	40.0	12.10	37.4	11.30	34.7	10.41	33.5	10.15	32.3	9.81	30.1	9.22
	15.0	13.7	40.0	11.51	37.4	10.79	34.7	9.94	33.5	9.68	32.3	9.37	30.1	8.79
	18.0	16.8	40.0	10.96	37.4	10.31	34.7	9.55	33.5	9.28	32.3	8.97	30.1	8.39
20.0	18.5	40.0	10.44	37.4	9.87	34.7	9.18	33.5	8.95	32.3	8.61	30.1	8.02	
24.0	20.5	40.0	9.95	37.4	9.45	34.7	8.55	33.5	8.65	32.3	8.27	30.1	7.68	

5.6 Capacity rectification for piping length and fall

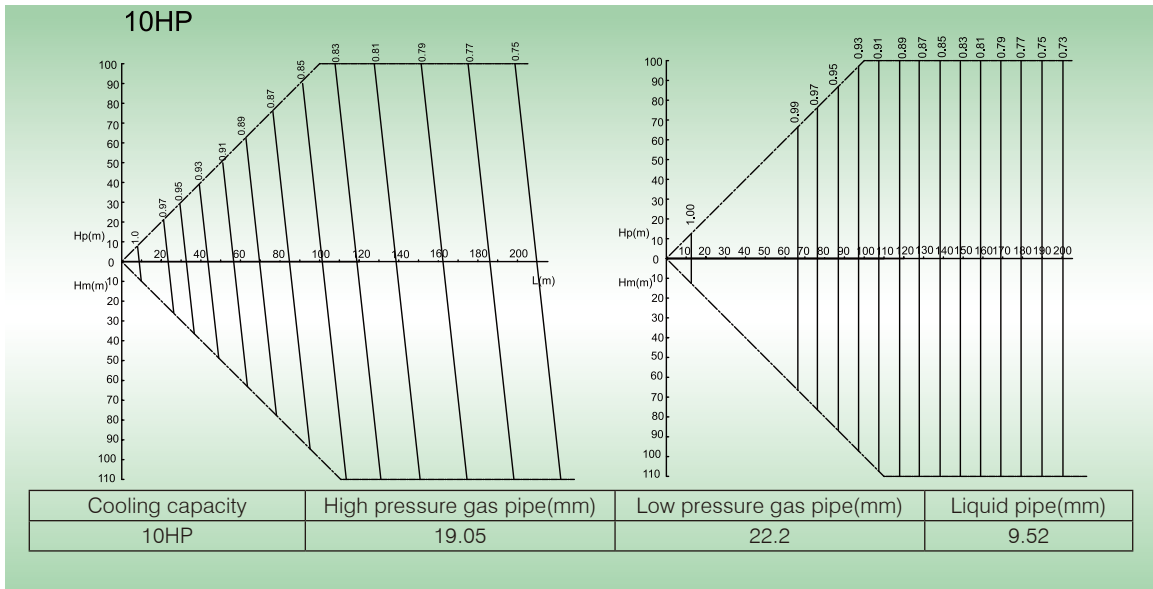
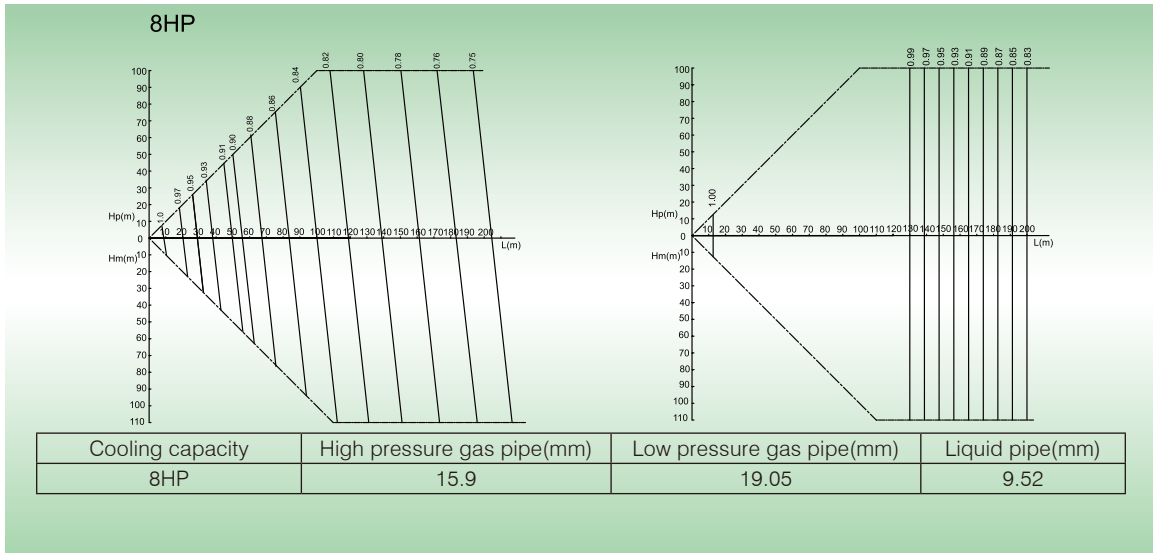

GMV6 HR DC Inverter VRF Units Technical Sales Guide

12HP 14HP 24HP 36HP

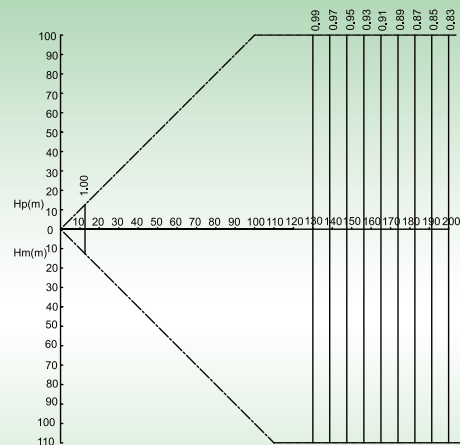
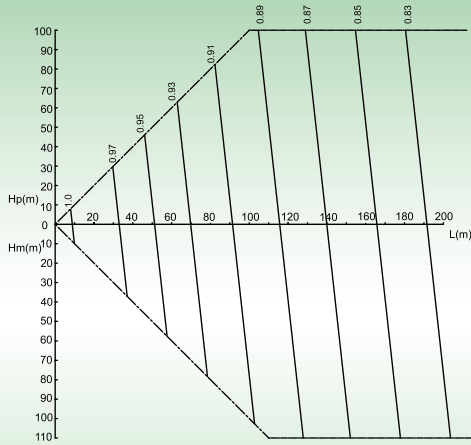

Cooling capacity	High pressure gas pipe(mm)	Low pressure gas pipe(mm)	Liquid pipe(mm)
12HP	19.05	25.4	12.7
14HP	22.2	25.4	12.7
24HP	25.4	28.6	15.9
36HP	31.8	38.1	19.05

16HP

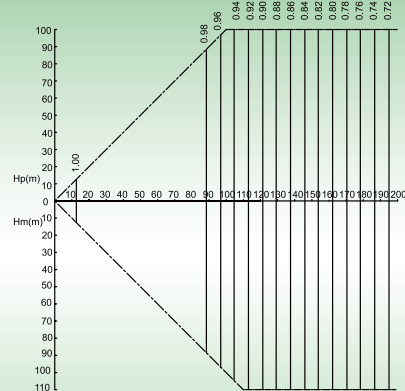
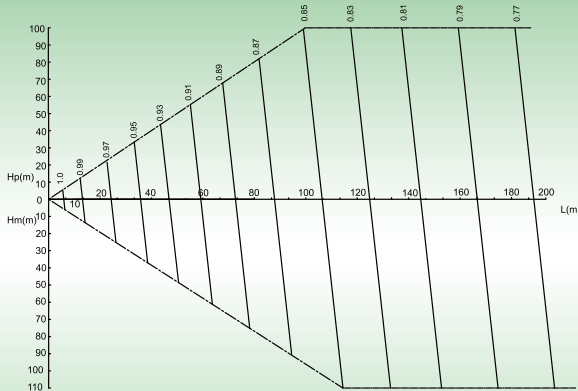

Cooling capacity	High pressure gas pipe(mm)	Low pressure gas pipe(mm)	Liquid pipe(mm)
16HP	22.2	28.6	12.7

18 HP 26-30HP 38-44HP

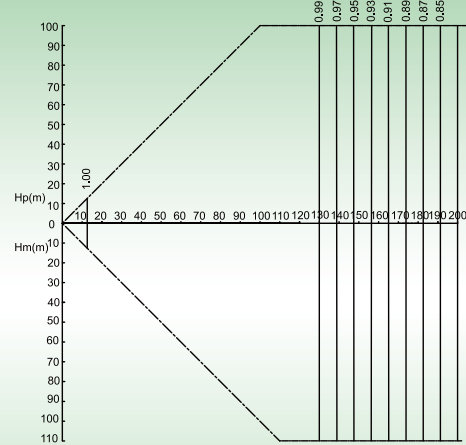
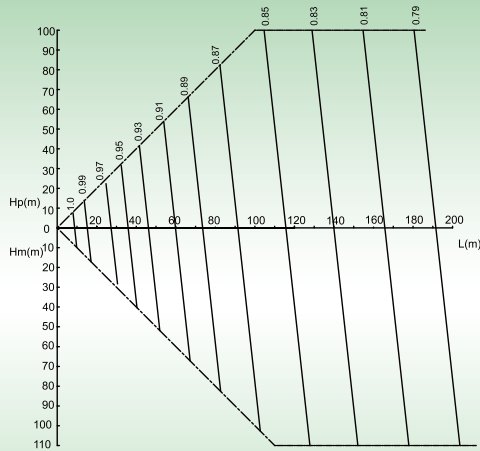

Cooling capacity	High pressure gas pipe(mm)	Low pressure gas pipe(mm)	Liquid pipe(mm)
18HP	25.4	28.6	15.9
26-30HP	28.6	31.8	19.05
38-44HP	31.8	38.1	19.05

20HP 32-34HP

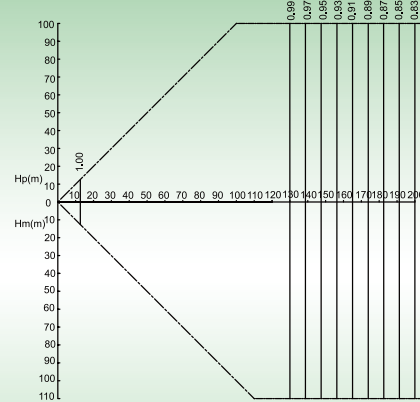
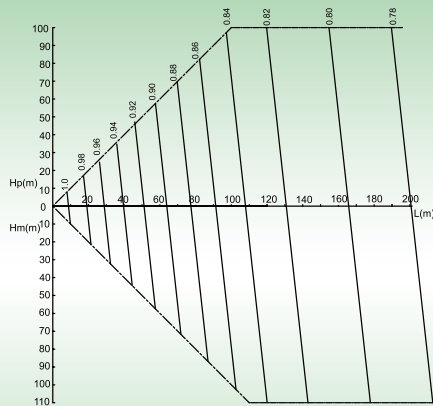

Cooling capacity	High pressure gas pipe(mm)	Low pressure gas pipe(mm)	Liquid pipe(mm)
20HP	25.4	28.6	15.9
32-34HP	28.6	31.8	19.05

GMV6 HR DC Inverter VRF Units Technical Sales Guide

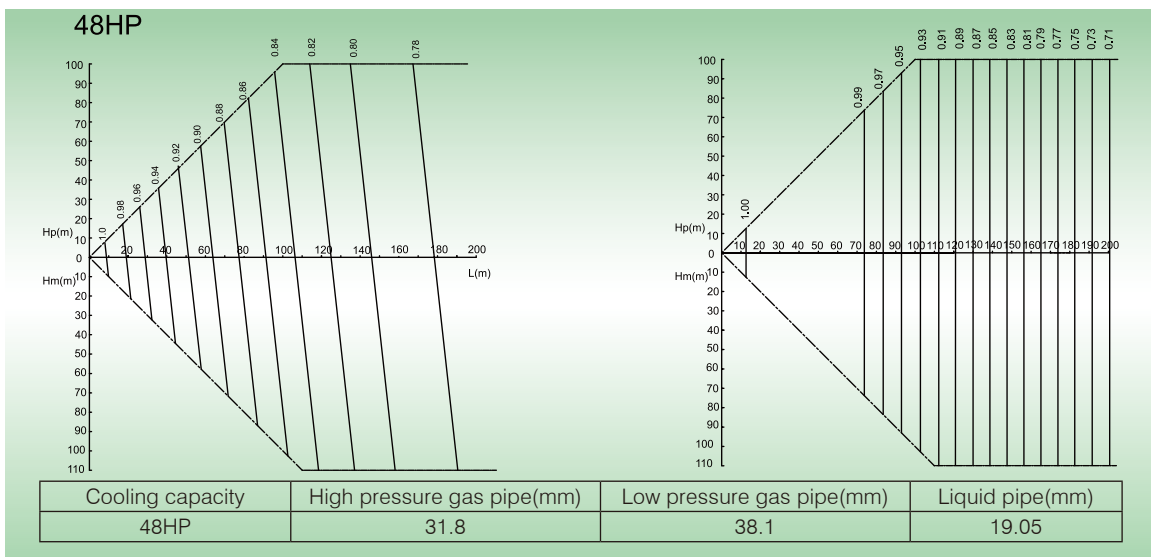
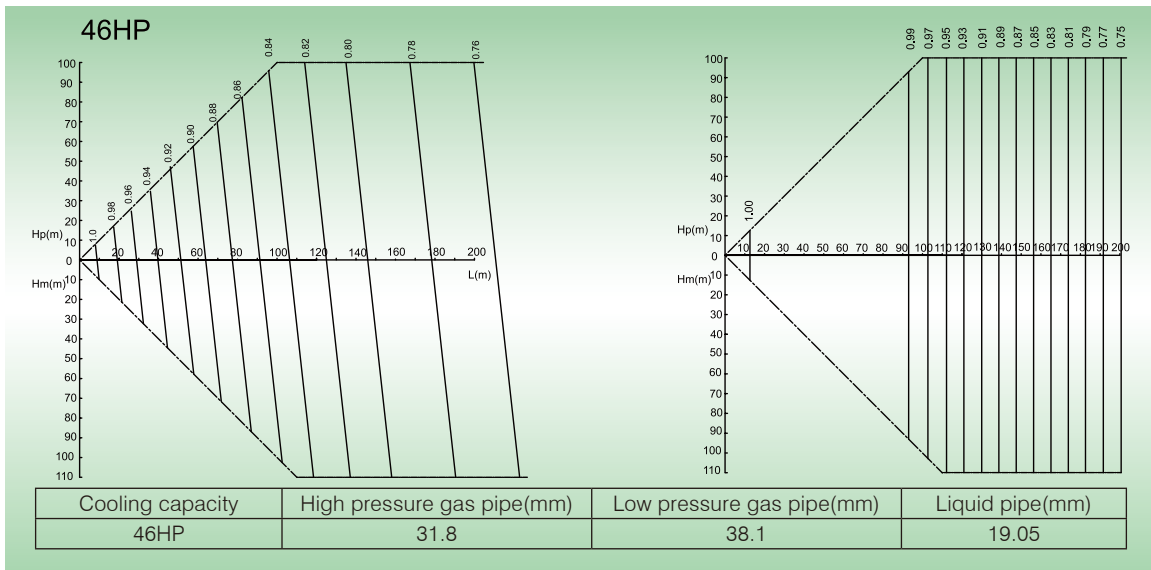
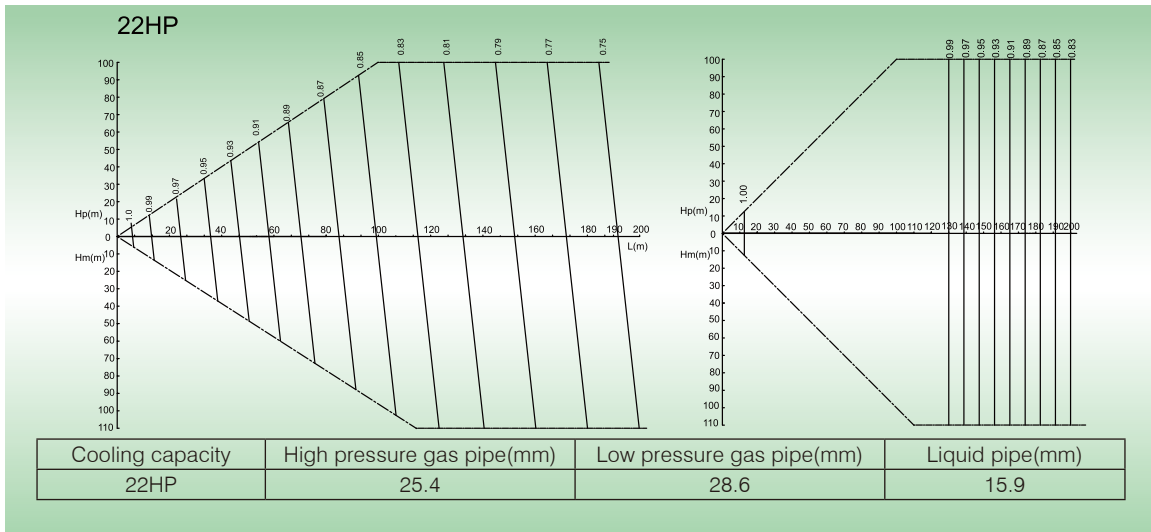

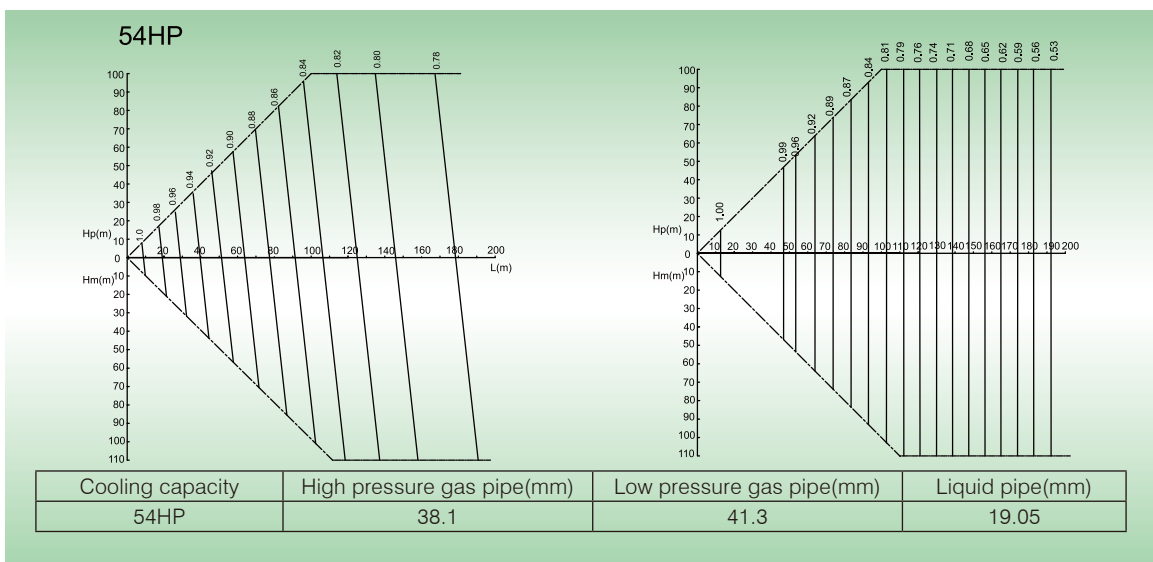
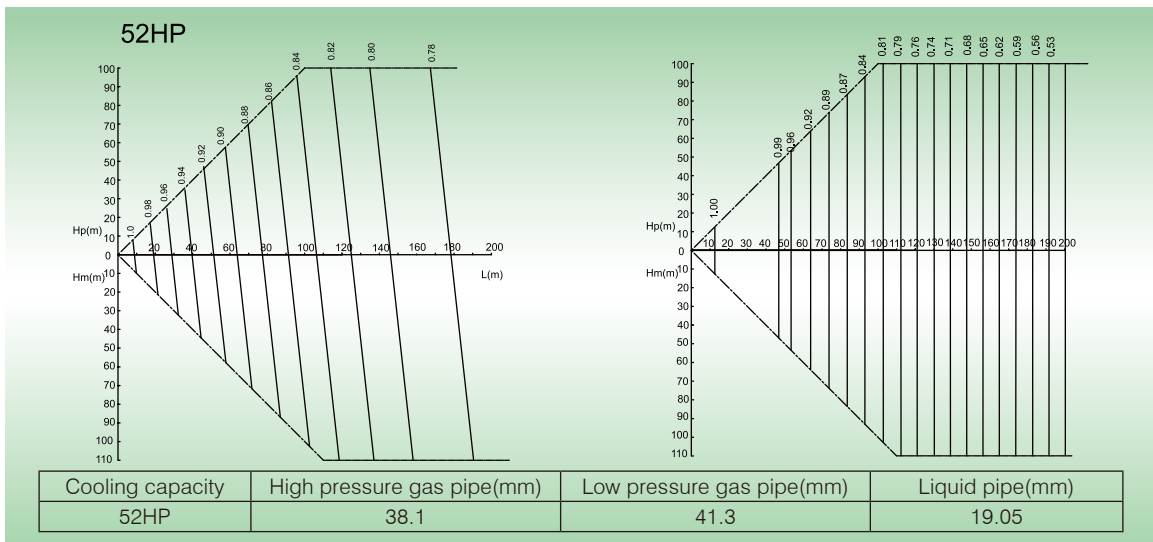
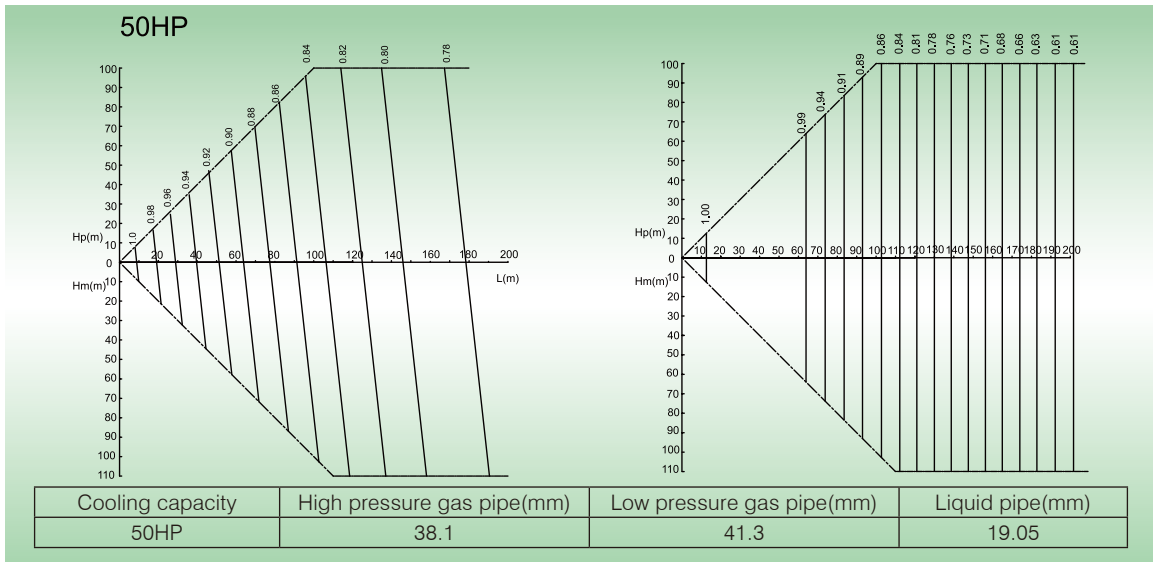

GMV6 HR DC Inverter VRF Units Technical Sales Guide

56HP

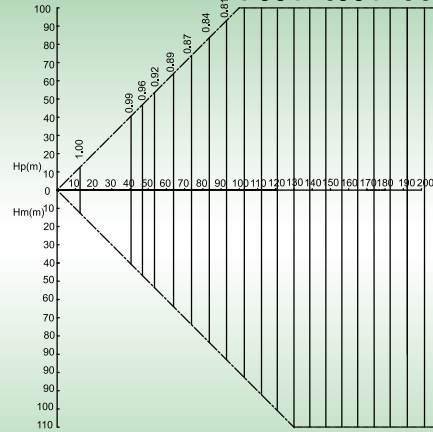
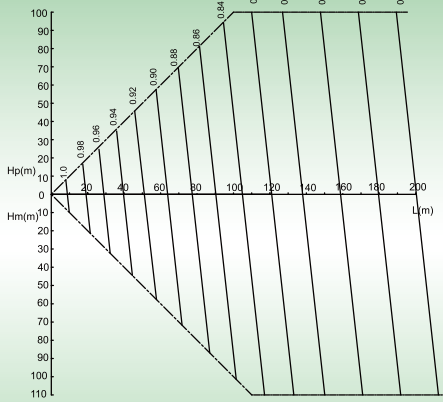

Cooling capacity	High pressure gas pipe(mm)	Low pressure gas pipe(mm)	Liquid pipe(mm)
56HP	38.1	41.3	19.05

58HP

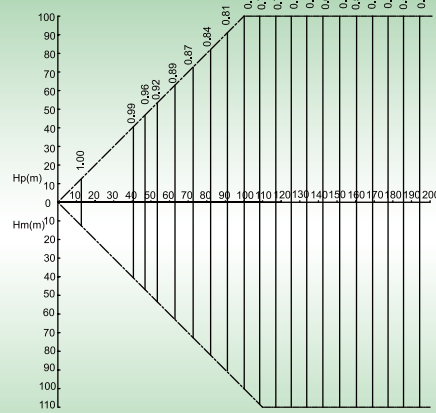
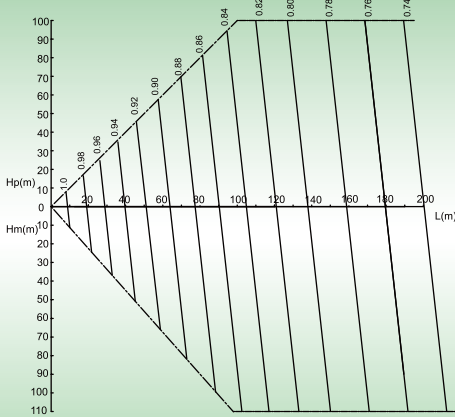

Cooling capacity	High pressure gas pipe(mm)	Low pressure gas pipe(mm)	Liquid pipe(mm)
58HP	38.1	41.3	19.05

60 - 66HP 68-88HP

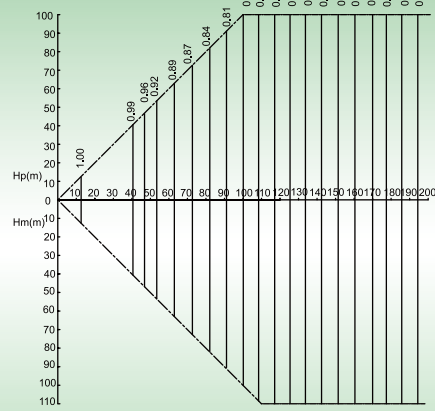
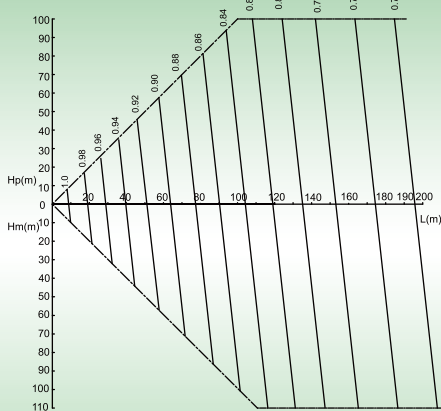

Cooling capacity	High pressure gas pipe(mm)	Low pressure gas pipe(mm)	Liquid pipe(mm)
60-66HP	38.1	41.3	19.05
68-88HP	41.3	44.5	22.2

Rectification specification of long connection pipe:

The above long connection pipe rectification is the max.capacity under standard IDU capacity allocation. Some of load configuration is as follow:

Max.system capacity: IDU capacity and the max.capacity of ODU, take the lesser one (two kinds of algorithms).

IDU allocation rate is below 100%

The max. capacity of ODU= the capacity in the ODU capacity rectification table when the allocation rate is $100\% \times \text{long connection pipe rectification coefficient of the furthest IDU}$

IDU allocation rate is 100%

The max. capacity of ODU= the capacity corresponds to the allocation rate in the ODU capacity rectification table \times long connection pipe rectification coefficient of the furthest IDU.

➔ 5.4 Rectification factor for heating defrosting

When outdoor environment has satisfied certain condition (temperature and humidity), frosting and defrosting might occur, at this time, heating capacity of the unit will be attenuated, therefore, when calculating heating load model selection, please add defrosting rectification factor.

Defrosting rectification factor is as follow:

Outdoor heat exchanger air inlet dry bulb temperature (°C /RH85%)	-11	-9	-7	-5	-3	0	3	5	7
Defrosting capacity rectification factor	1	0.98	0.96	0.94	0.88	0.8	0.84	0.9	1

6 UNIT NOISE CURVES

6.1 Outdoor Unit Noise Curve

Test method for noise :

Test environment: Semi-anechoic room, the noise will be a little bit higher in actual operation due to environmental change.

Noise curve test point is as follow:

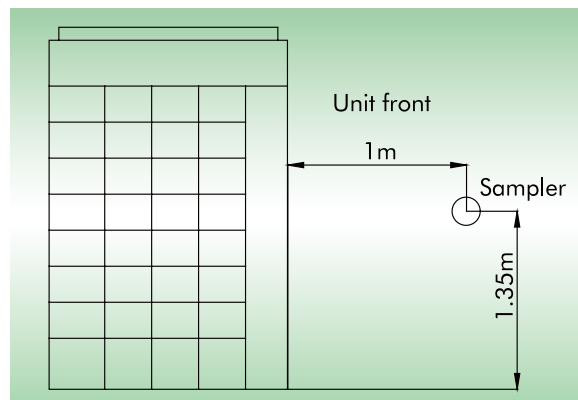

GMV-VQ224WM/C-X

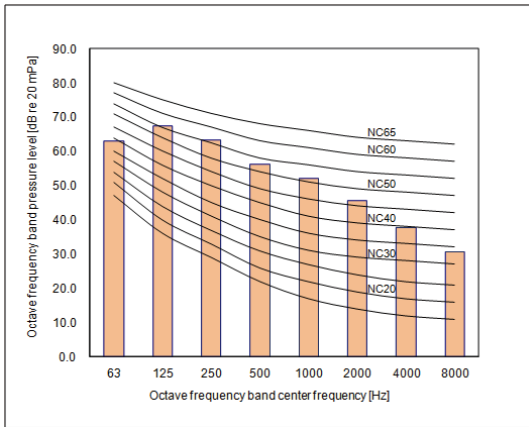

GMV-VQ280WM/C-X

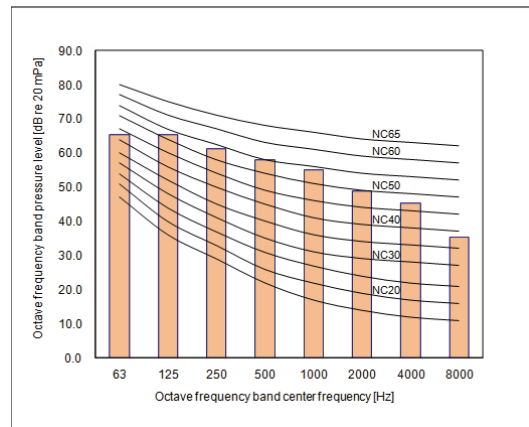

GMV-VQ335WM/C-X

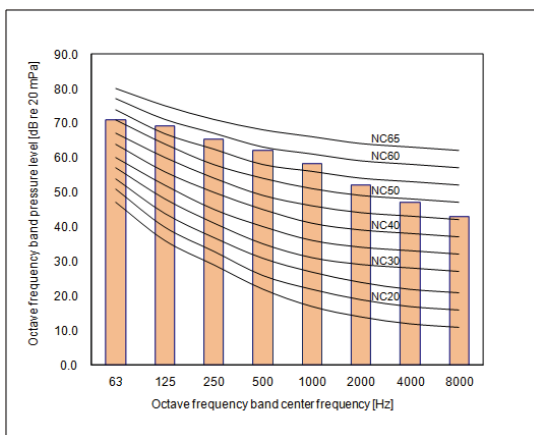

GMV-VQ400WM/C-X

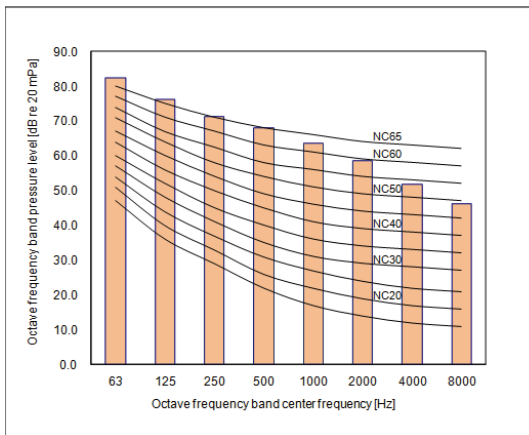

GMV-VQ450WM/C-X

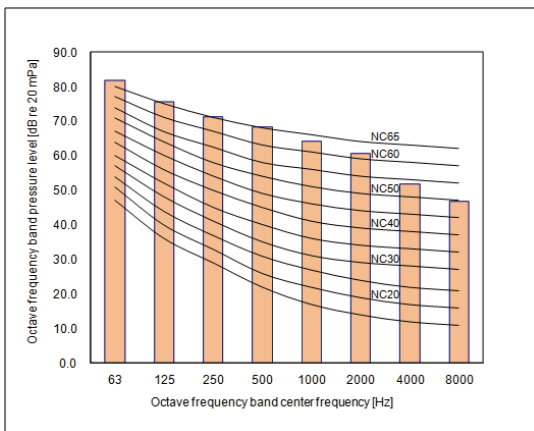

GMV-VQ504WM/C-X

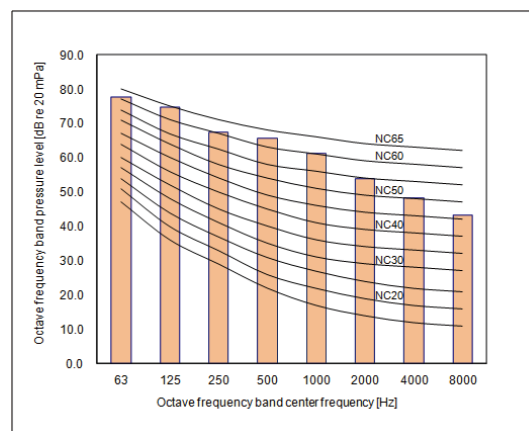

GMV-VQ560WM/C-X

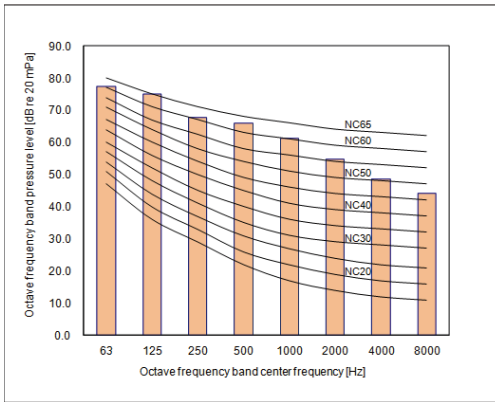

GMV-VQ615WM/C-X

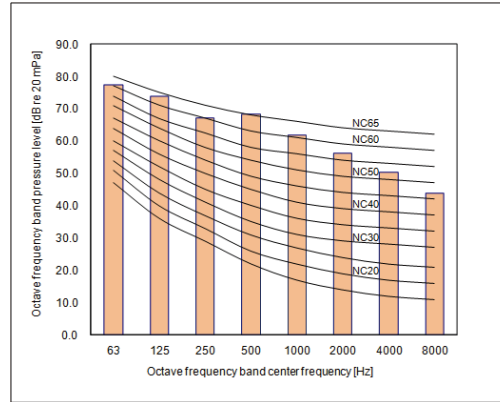

7 UNIT GRAVITY CENTER DIAGRAMS

Unit : mm

GMV-VQ224WM/C-X, GMV-VQ280WM/C-X, GMV-VQ335WM/C-X

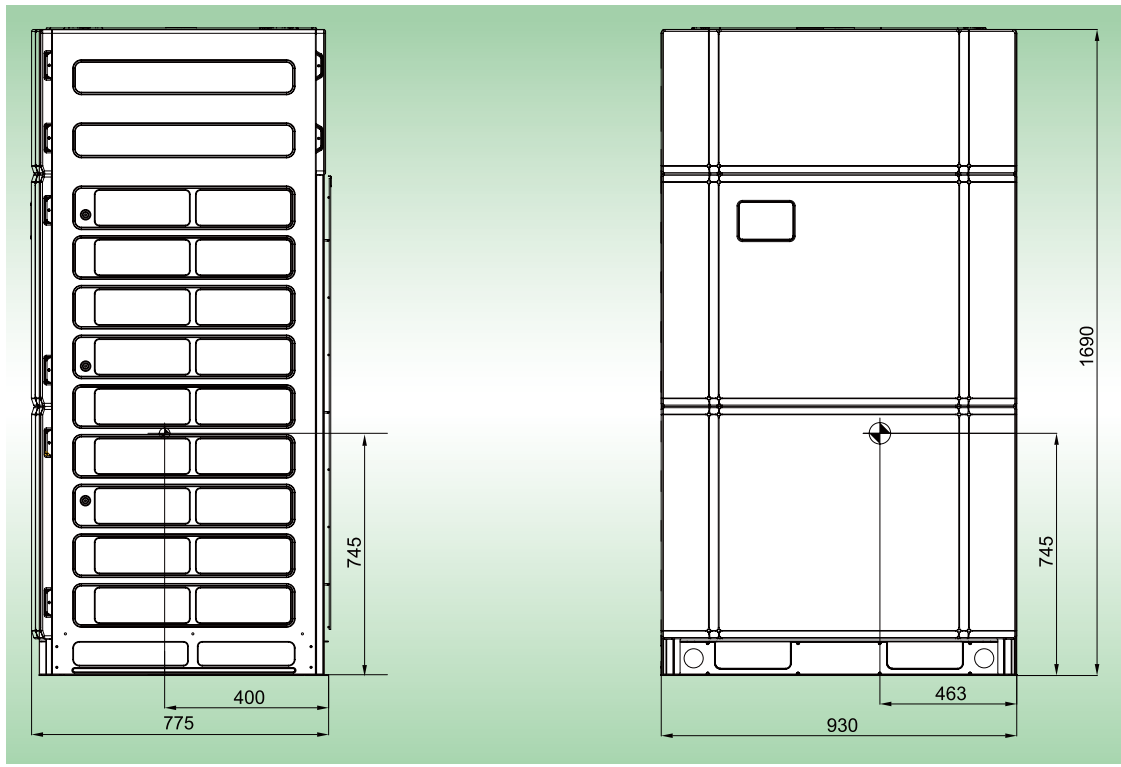

GMV6 HR DC Inverter VRF Units Technical Sales Guide

GMV-VQ400WM/C-X, GMV-VQ450WM/C-X

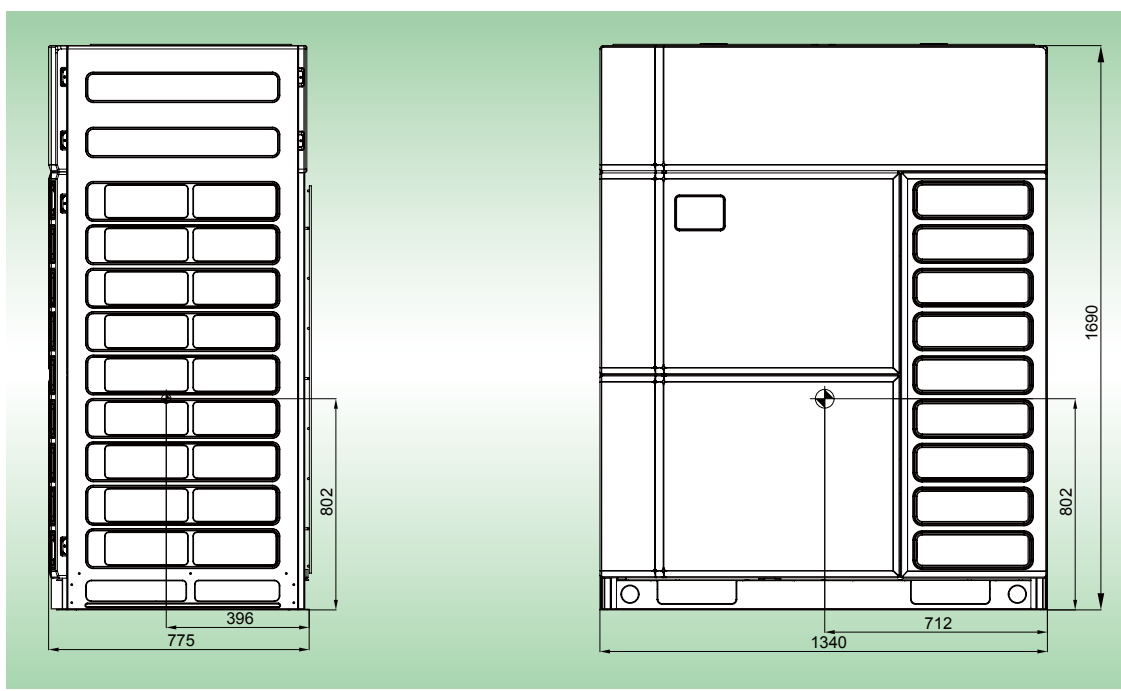

GMV-VQ504WM/C-X, GMV-VQ560WM/C-X, GMV-VQ615WM/C-X

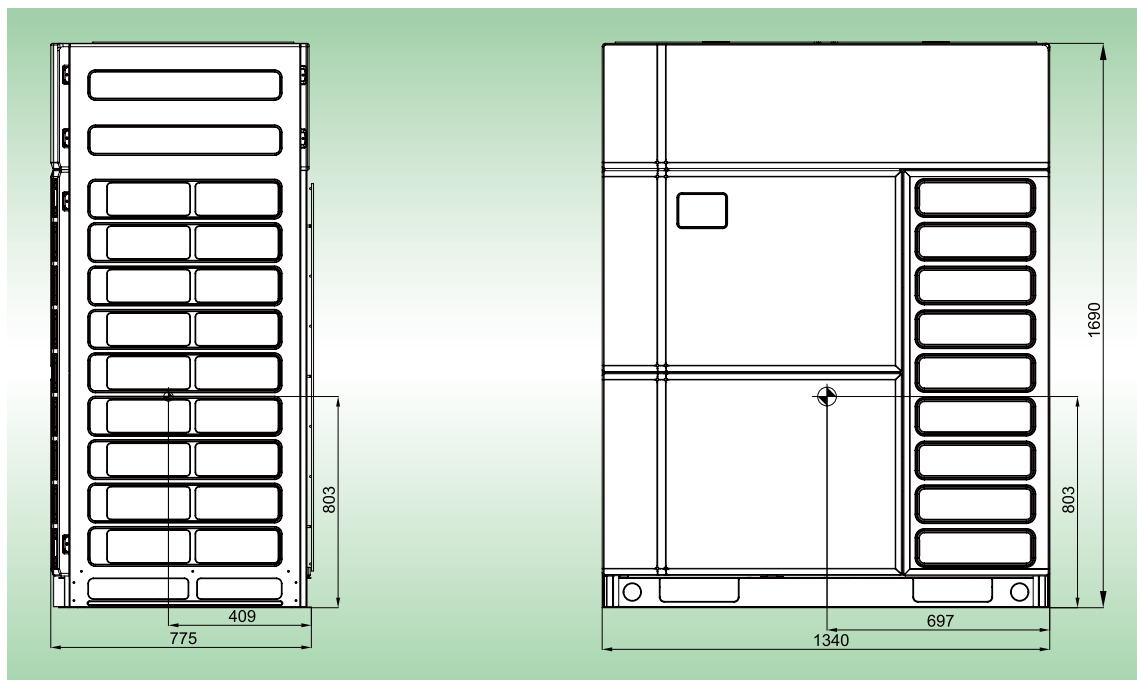

8 PRODUCT SIZE AND INSTALLATION

8.1 Product size and installation of outdoor unit

8.1.1 Outline size and installation hole size

Unit : mm

Outline size and installation hole size of GMV-VQ224WM/C-X, GMV-VQ280WM/C-X and GMV-VQ335WM/C-X

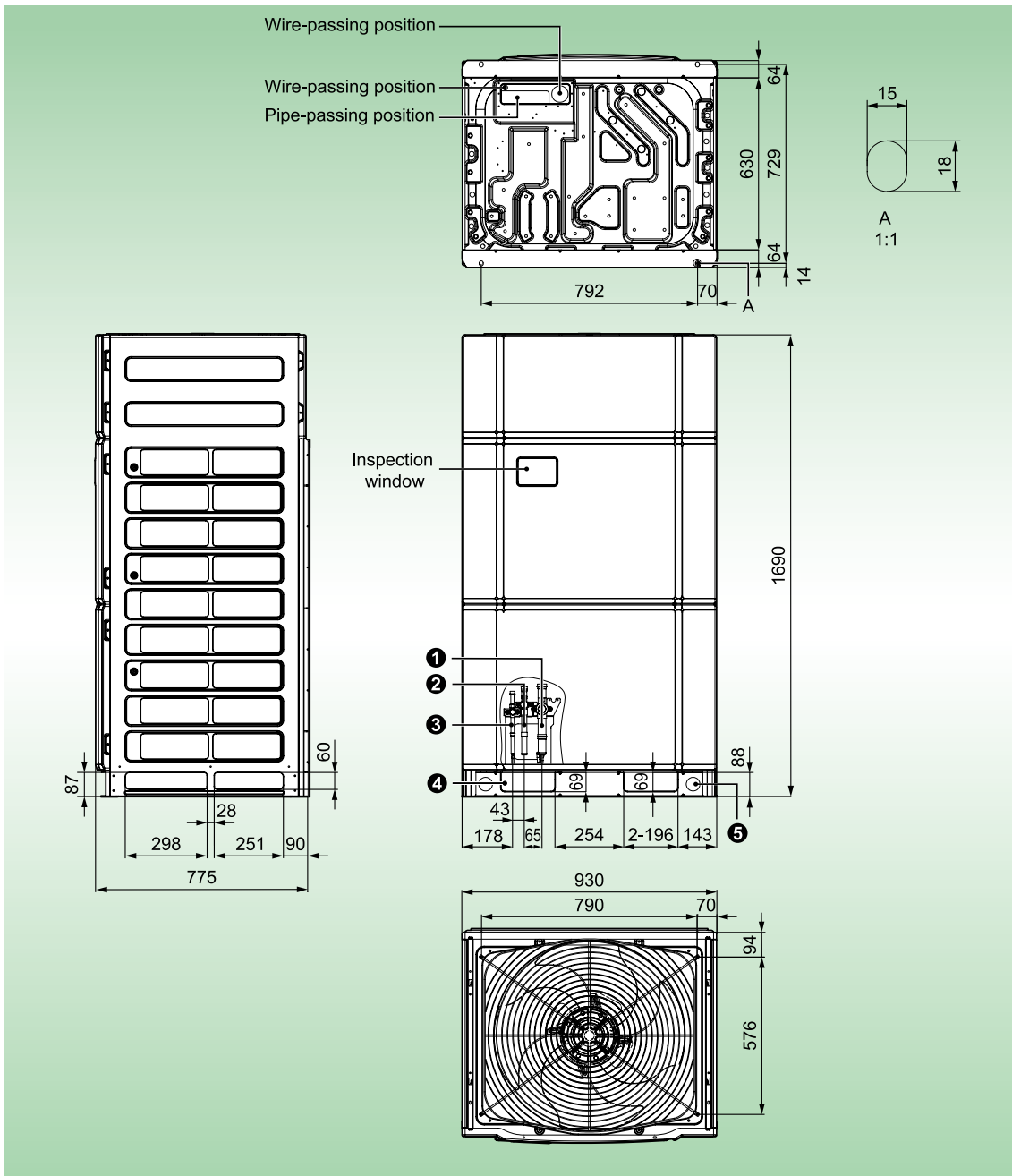

GMV6 HR DC Inverter VRF Units Technical Sales Guide

No.	Name	Pipe diameter(mm)		
		GMV-VQ224WM/C-X	GMV-VQ280WM/C-X	GMV-VQ335WM/C-X
①	Low pressure gas pipe	Φ19.05	Φ22.2	Φ25.4
②	High pressure gas pipe	Φ15.9	Φ19.05	Φ19.05
③	Liquid pipe	Φ9.52	Φ9.52	Φ12.7
④	Wire-passing hole (L×W)	196×69	196×69	196×69
⑤	Lifting hole	Φ50	Φ50	Φ50

Outline size and installation hole size of GMV-VQ400WM/C-X, GMV-VQ450WM/C-X, GMV-VQ504WM/C-X, GMV-VQ560WM/C-X and GMV-VQ615WM/C-X

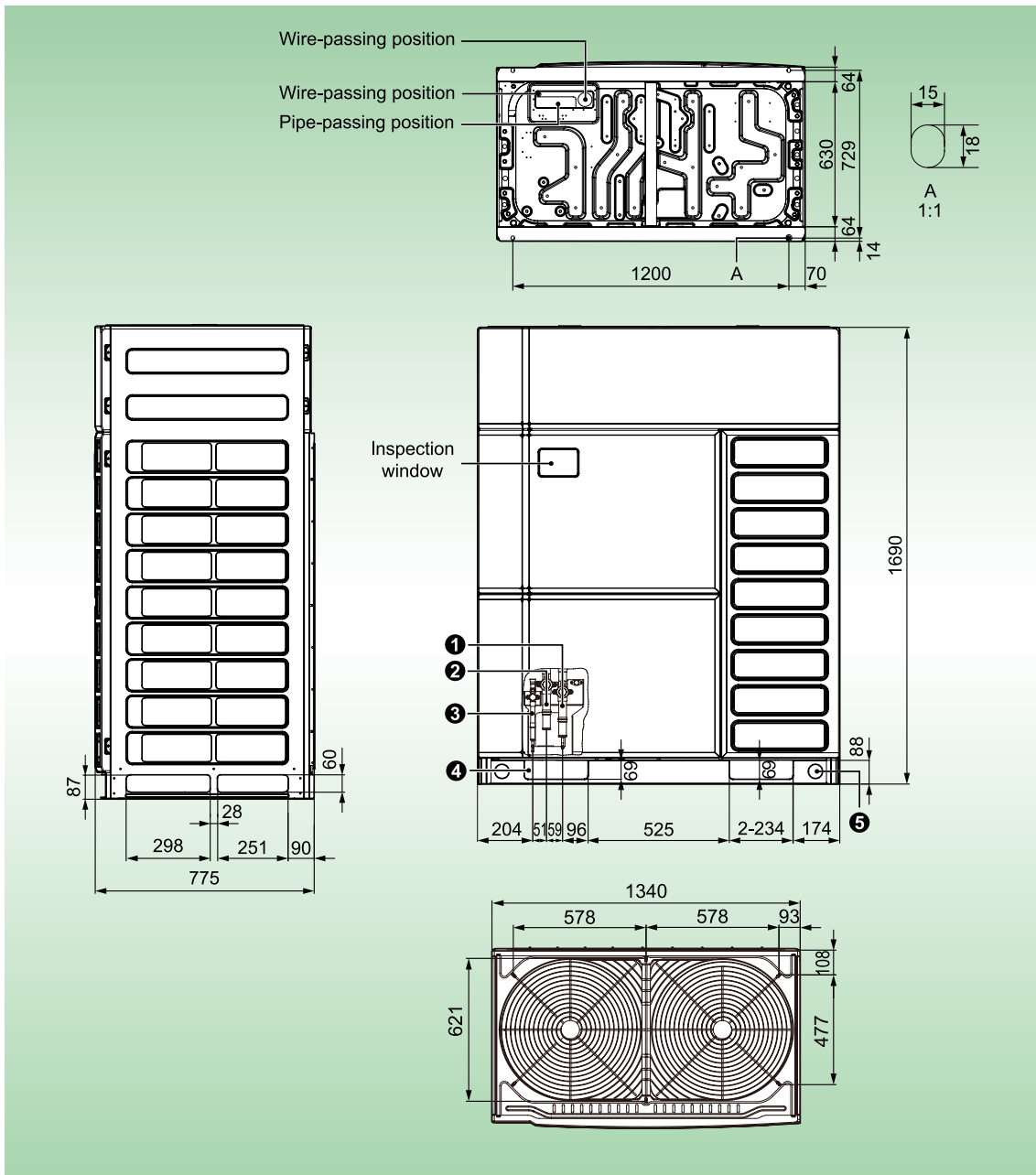

No.	Name	Pipe diameter(mm)		
		GMV-VQ400WM/C-X	GMV-VQ450WM/C-X	GMV-VQ504WM/C-X
①	Low pressure gas pipe	Φ25.4	Φ28.6	Φ28.6
②	High pressure gas pipe	Φ22.2	Φ22.2	Φ25.4
③	Liquid pipe	Φ12.7	Φ12.7	Φ15.9
④	Wire-passing hole (L×W)	234×69	234×69	234×69
⑤	Lifting hole	Φ50	Φ50	Φ50

No.	Name	Pipe diameter(mm)	
		GMV-VQ560WM/C-X	GMV-VQ615WM/C-X
①	Low pressure gas pipe	Φ28.6	Φ28.6
②	High pressure gas pipe	Φ25.4	Φ25.4
③	Liquid pipe	Φ15.9	Φ15.9
④	Wire-passing hole (L×W)	234×69	234×69
⑤	Lifting hole	Φ50	Φ50

8.1.2 Select installation position of ODU

Conditions for selecting the installation position

- (1) Install the unit at a place where is adequate to withstand the weight of the unit and make sure the unit would not shake or fall off.
- (2) Fully consider the influence of strong winds, typhoons and earthquakes when selecting the installation site, and strengthen the installation.
- (3) The influence of flammable, explosive, corrosive gases or exhaust gases should be avoided.
- (4) Ensure that there is a certain space for heat exchanging and maintenance, so that the ventilation is smooth and the running is reliable.
- (5) Outdoor units and indoor units should be as close as possible to minimize the length and angle of the cooling pipes.
- (6) Do not allow children to approach the unit. Preventive measures should be taken to prevent children from contacting the unit.
- (7) The unit should not be installed in places with high environmental pH or high voltage fluctuations, and places such as vehicles and ships.
- (8) Do not install the unit at the place where is close to the equipment that generates electromagnetic waves. Electromagnetic waves can affect the control system and cause fault.

8.1.3 Installation space requirements

The installation space of the unit should consider the maintenance space of the unit and the ventilation of the unit. Select an installation method according to the actual situation.

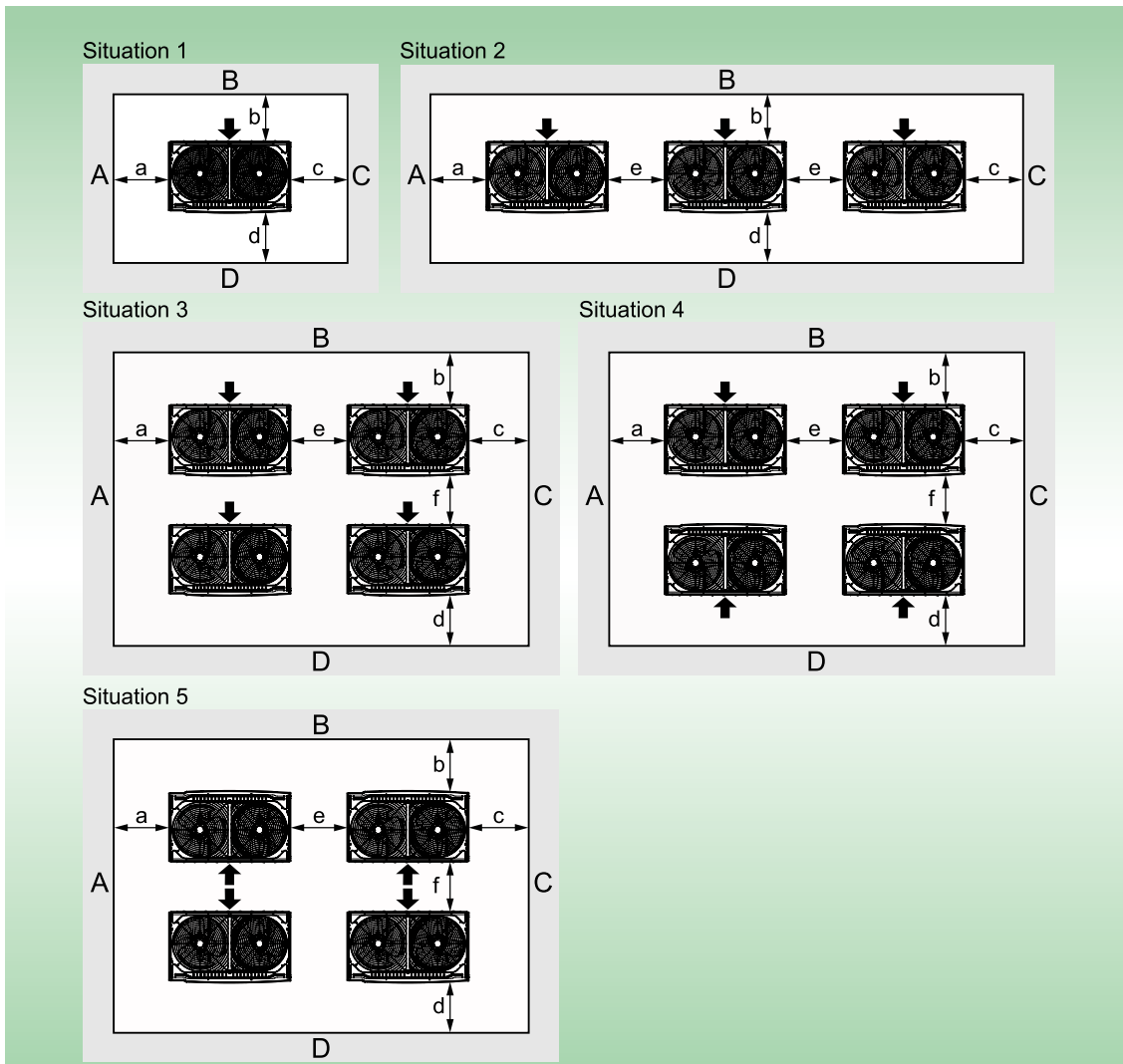

Unit : mm

Situation	A+B+C+D	A+B
Situation 1	$a \geq 300$ $b \geq 100$ $c \geq 100$ $d \geq 500$	$a \geq 300$ $b \geq 300$
Situation 2	$a \geq 300$ $b \geq 100$ $c \geq 100$ $d \geq 500$ $e \geq 100$	$a \geq 300$ $b \geq 300$ $e \geq 400$
Situation 3	$a \geq 300$ $b \geq 100$ $c \geq 100$ $d \geq 500$ $e \geq 200$ $f \geq 600$	-

Situation	A+B+C+D	A+B
Situation 4	$a \geq 300$ $b \geq 100$ $c \geq 100$ $d \geq 100$ $e \geq 200$ $f \geq 500$	-
Situation 5	$a \geq 300$ $b \geq 500$ $c \geq 100$ $d \geq 500$ $e \geq 200$ $f \geq 900$	-

NOTES:

- a. The installation space shown above is based on the cooling operation when the outdoor temperature is 35°C. If the outdoor temperature exceeds 35°C or the heat load is large, and all outdoor units are operating at an excess capacity, the space at the suction side should be increased.
- b. When disassembling or installing the unit, the operation may be affected by obstacles, and the distance from the unit to the wall surface may be appropriately increased.
- c. When two or more units are installed and placed, the operation may be affected by the adjacent units. The distance between the two adjacent units is "e" ≥ 100 mm.

Unit : mm

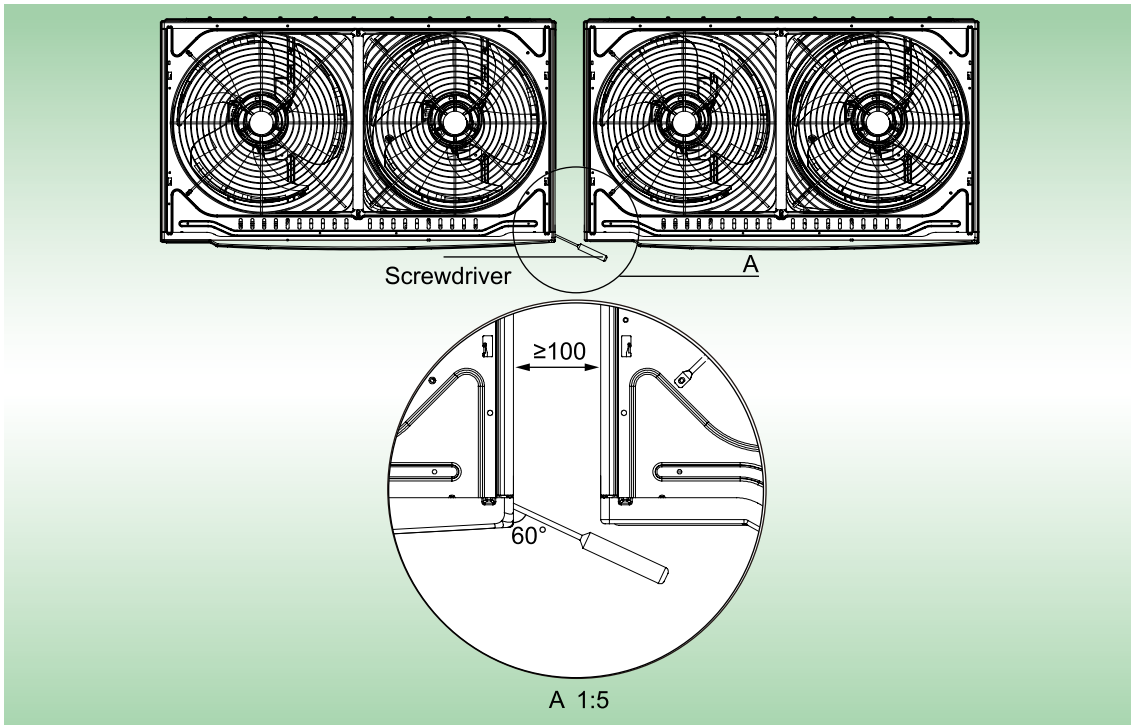

- d. If the unit is installed in the space with four walls, wall height at both side of the unit shall have no limit; wall height at return air side is below 500mm and at the front side is below 1,500mm. The unit is installed in a space with only two walls, A and B, and the height of the B wall is not limited.
- e. If the wall exceeds the above value, increase the space as follows.

Unit : mm

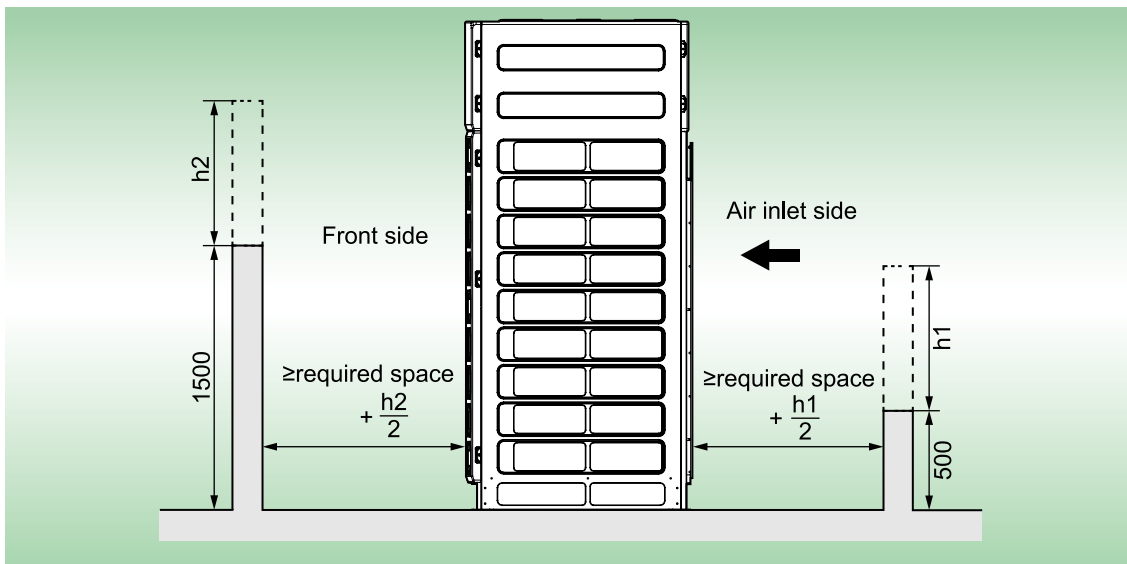

f. If there is an obstacle above the unit, install the unit as follows.

In principle, the top of the unit is required to be more than 3000 mm from the top wall. If the space around the front, back, left and right sides of the unit is open space, the top of the unit is required to be 1500mm or more from the top wall, as shown in the fig. as below. If the size is less than 1500mm, or if the space around the unit is not open, you need to connect an exhaust duct for smooth ventilation, as shown below.

Unit : mm

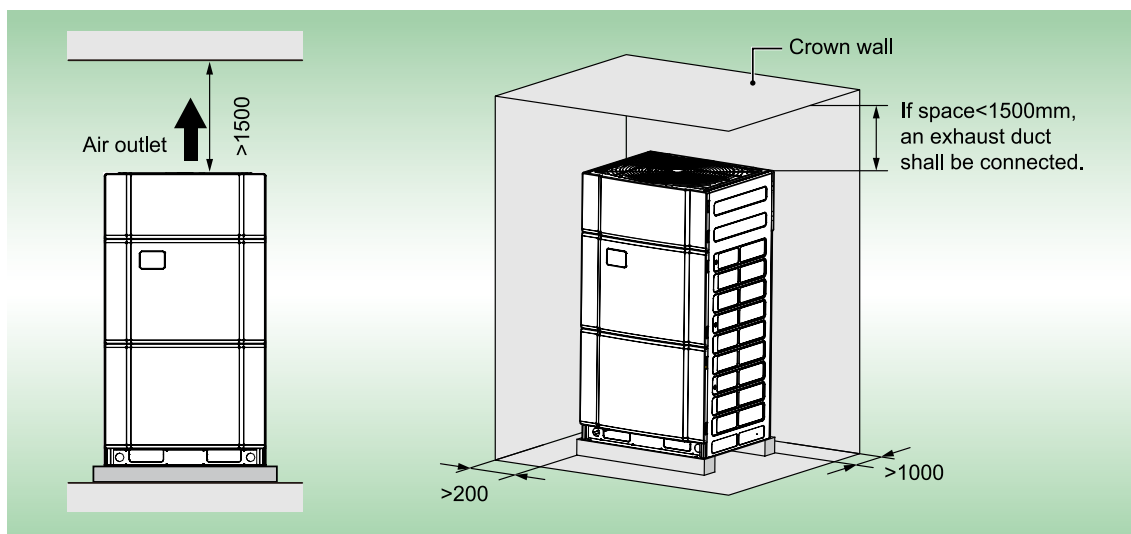

8.1.4 Take seasonal wind into consideration when installing the outdoor unit

(1) Anti-monsoon installation requirements for unit not connecting exhaust duct.

When the exhaust duct is not connected, a protective cover should be installed according to the seasonal wind circumstances.

Note: The photo is only for reference. Please refer to the installation locale.

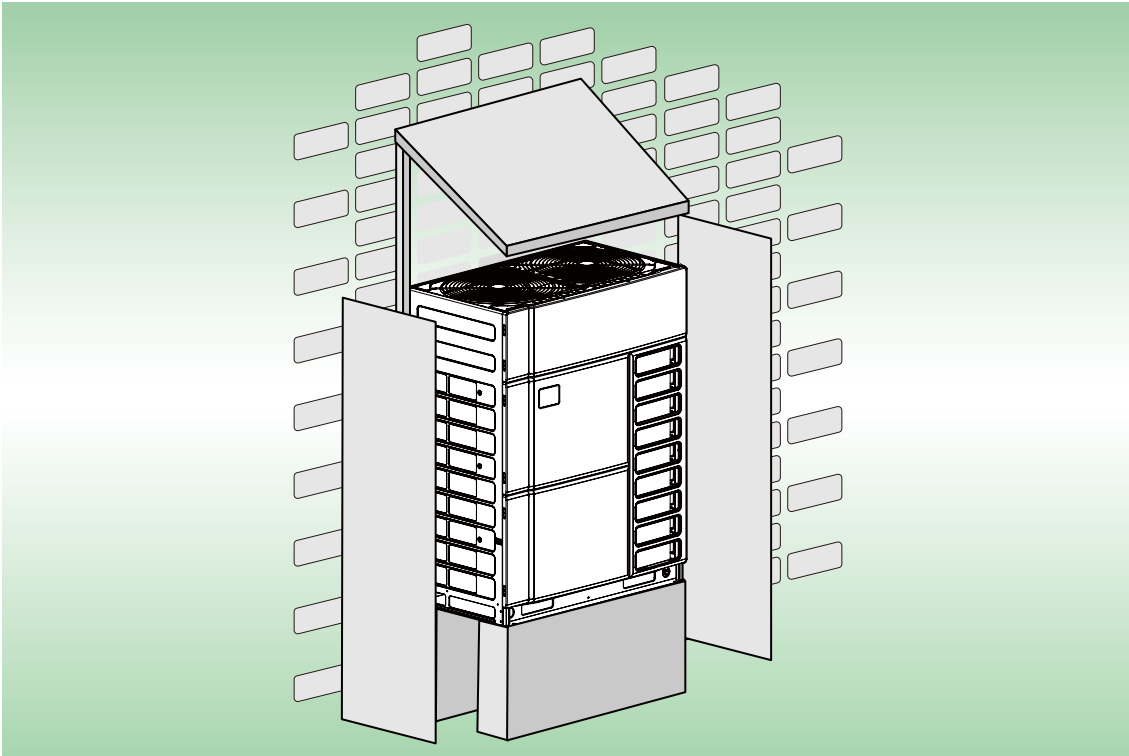

(2) Anti-monsoon installation requirements for unit connecting exhaust duct:

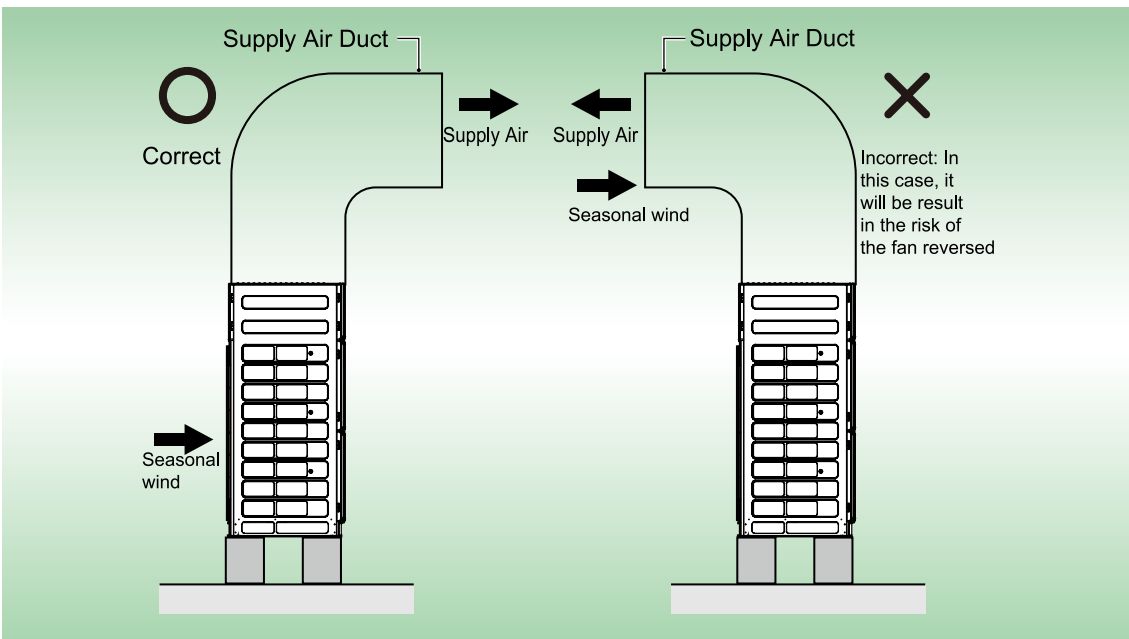

8.1.5 Take snow into consideration when installing the outdoor unit

When the unit is installed, the snow should be taken into consideration for the height of the base.

Note: The photo is only for reference. Please refer to the installation locale.

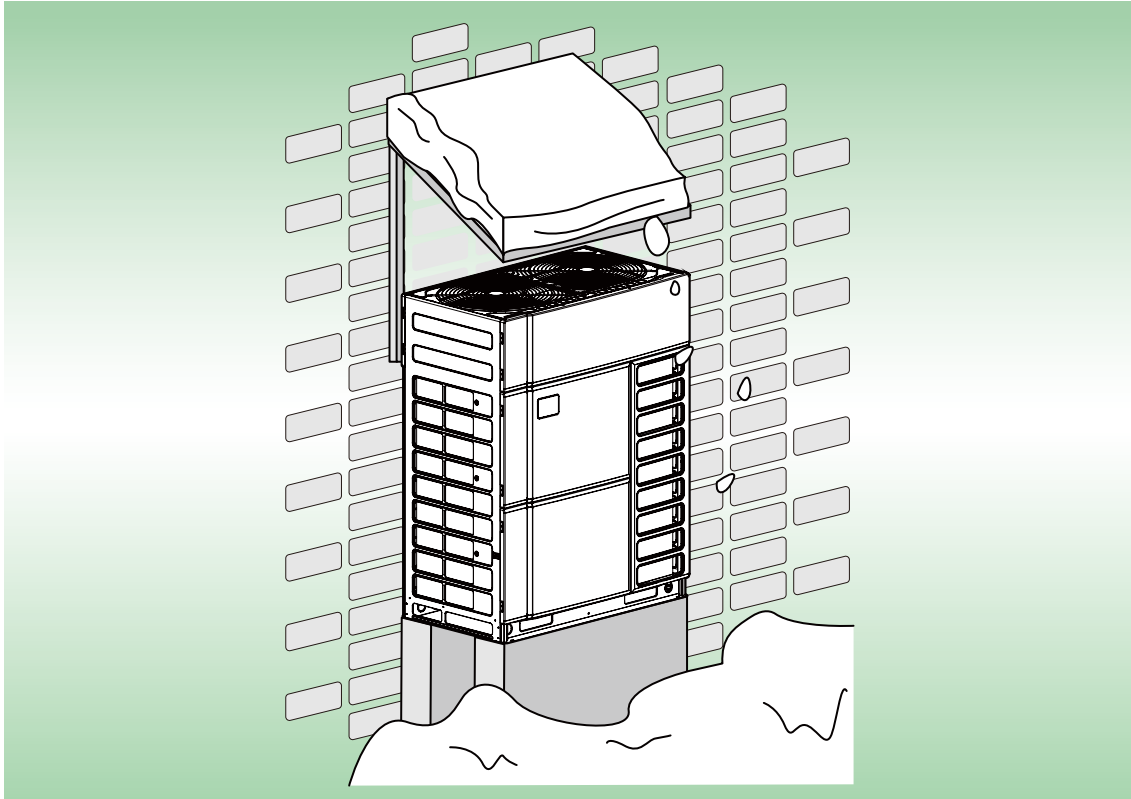

8.1.6 Installation space requirements for equipment floor

When the outdoor unit is installed in the equipment floor, it needs to connect an air exhaust duct.

The opening ratio of the shutters in the equipment floor is not less than 60%, and the horizontal angle of louvers is less than 20°.

8.1.7 Diagram of installation foundation

The concrete foundation of the ODU must be strong enough. Ensure that the drainage is smooth and that the ground drainage or floor drainage is not affected.

Requirements on the concrete foundation are as follows:

- (1) The concrete foundation must be flat and have enough rigidity and strength to undertake the unit's weight during running. The height of the foundation is 200 mm to 300 mm, which is determined based on the size of the unit. If it is installed in place with large snowfall, increase the height of the foundation so that the air inlet side is not buried by snow.
- (2) Build a drainage ditch around the foundation to discharge the condensate water.
- (3) If the air conditioner is installed on the roof, check the intensity of the building and take waterproof measures.
- (4) If a u-steel foundation is adopted, the structure must be designed with sufficient rigidity and strength.

Unit : mm

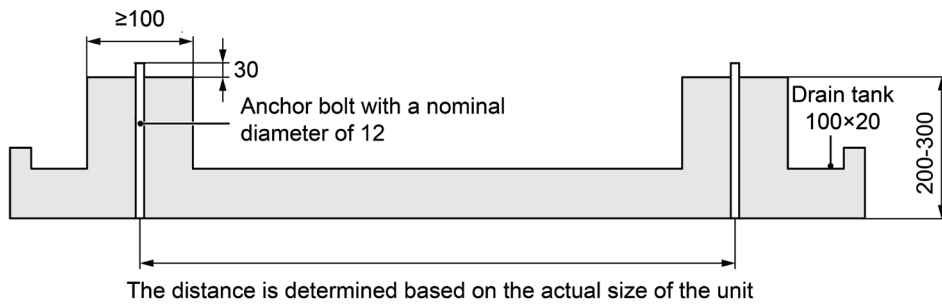

8.1.8 Shock absorption requirements

The outdoor unit should be firmly fixed. Thick rubber sheets or corrugated rubber damping rubber mats with a thickness of 20mm at least and a width of 100mm at least should be placed between the unit and the foundation. The installation requirements are shown as follows.

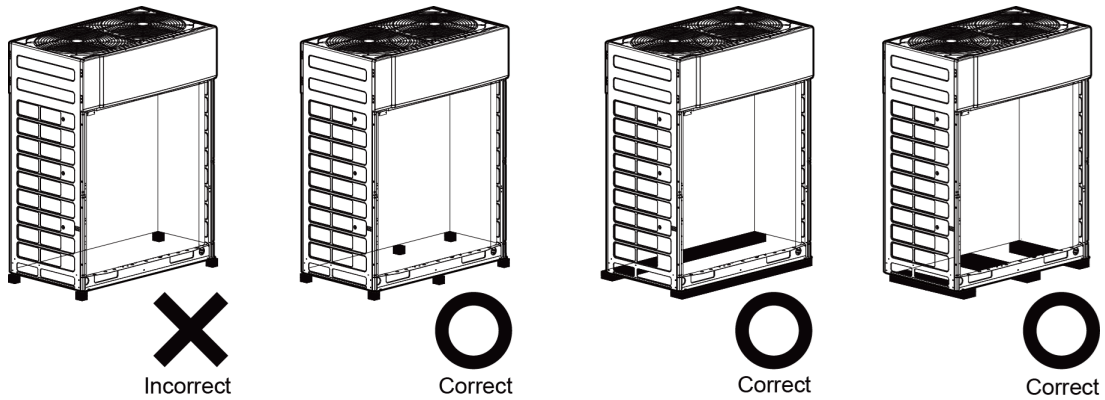

8.2 Product size and installation of mode exchange box

8.2.1 Outline size and installation hole size

Unit : mm

NCHS1D outline and installation dimension:

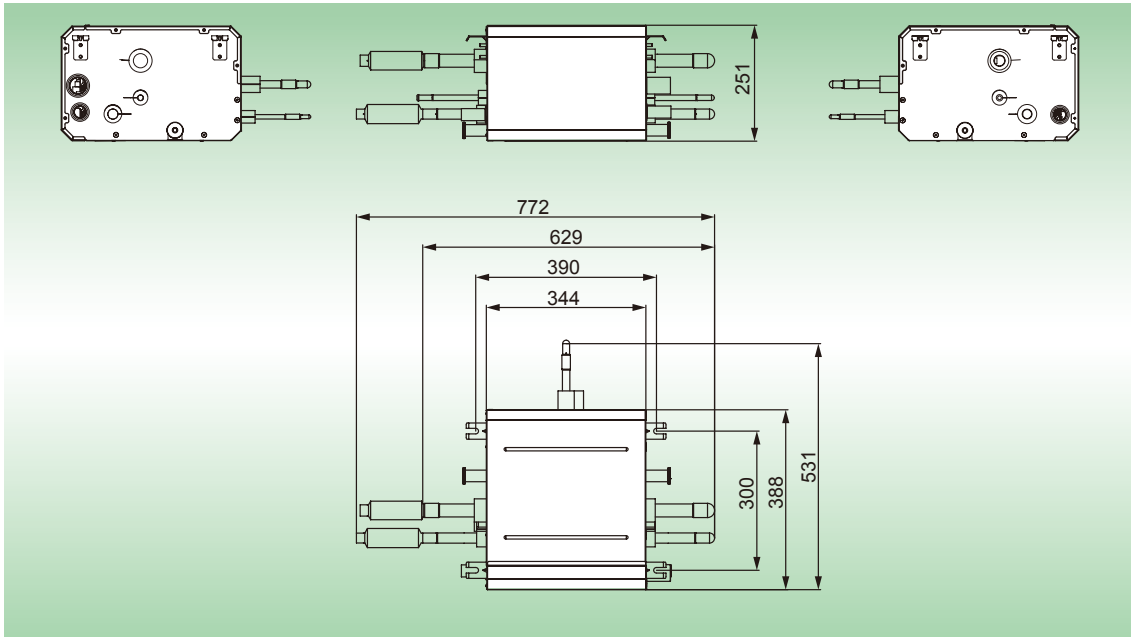

NCHS2D outline and installation dimension:

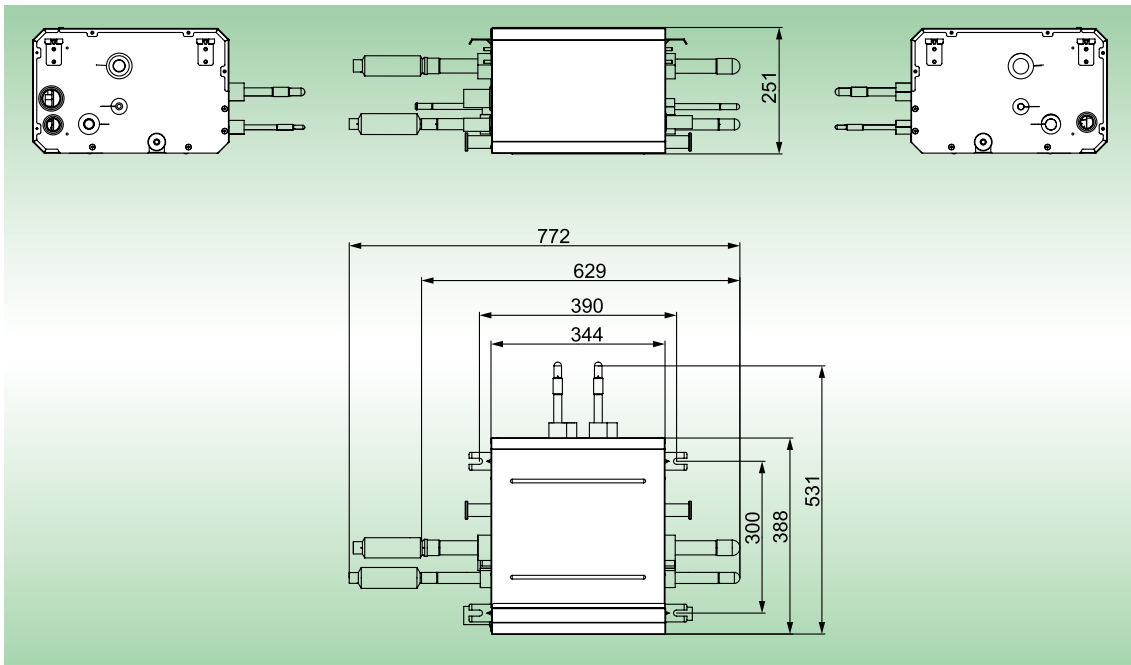

NCHS4D outline and installation dimension:

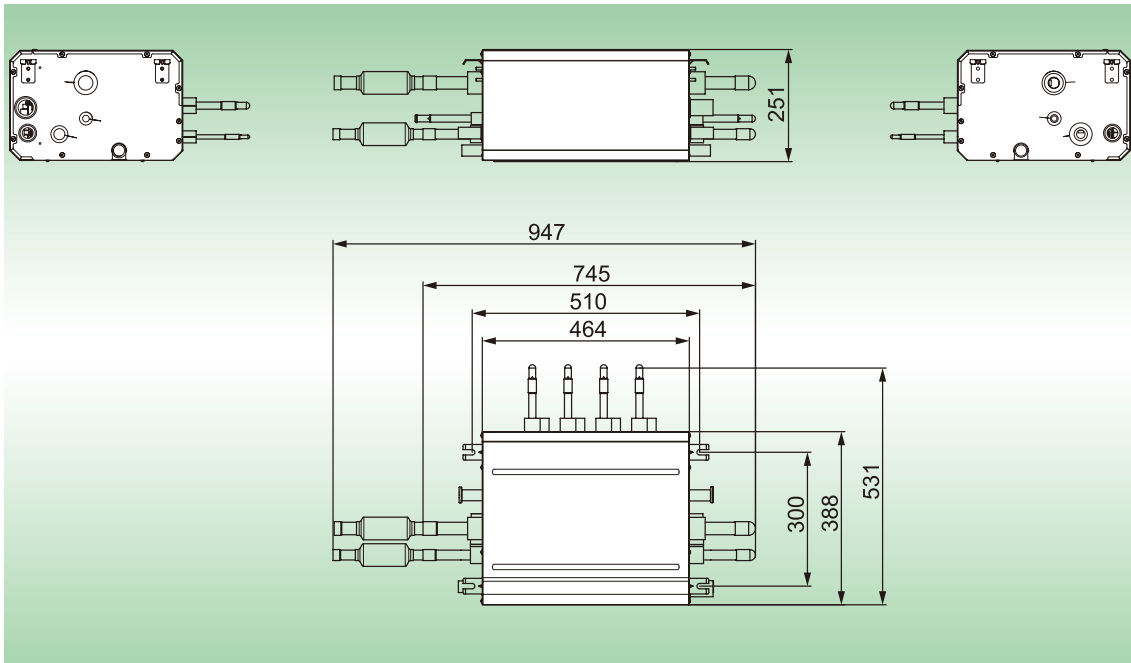

NCHS8D outline and installation dimension:

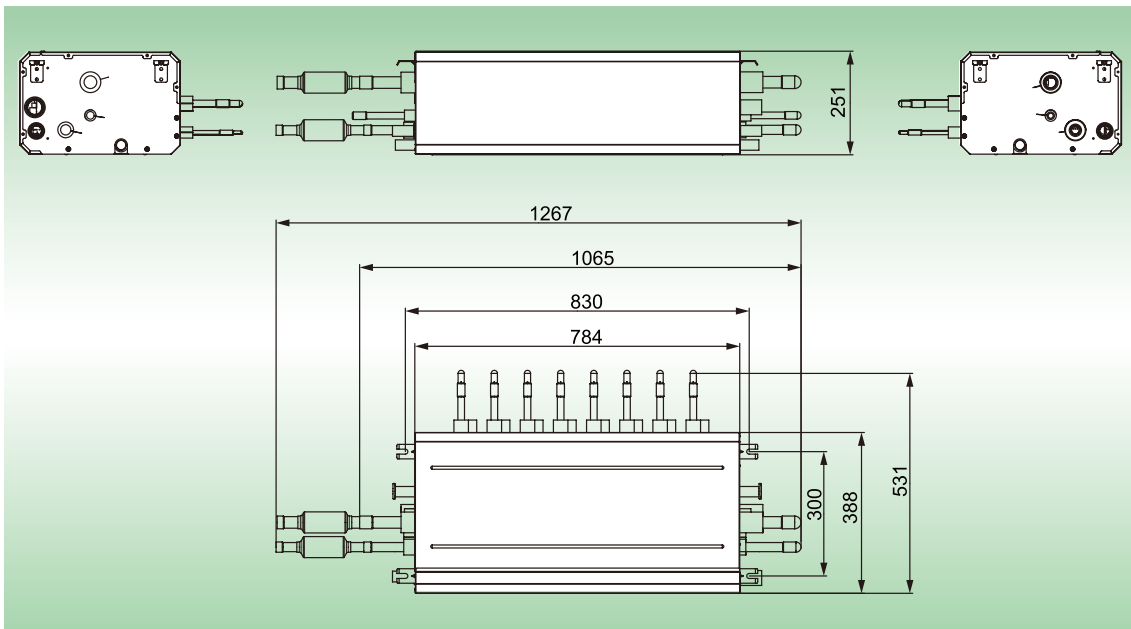

8.2.2 Dimension of Outdoor Unit and Mounting Hole Position

After the unit is installed, a maintenance port should be reserved at the electric box side of unit for maintenance. The position of maintenance port should be lower than the lower size of unit.

The Mode Exchange Box shall be installed near the maintenance port or air return of indoor unit. (Note: if it is installed near the air return, please make sure not to affect air return and maintenance).

The following pictures detailed describe the installation of maintenance port and Mode Exchange Box:

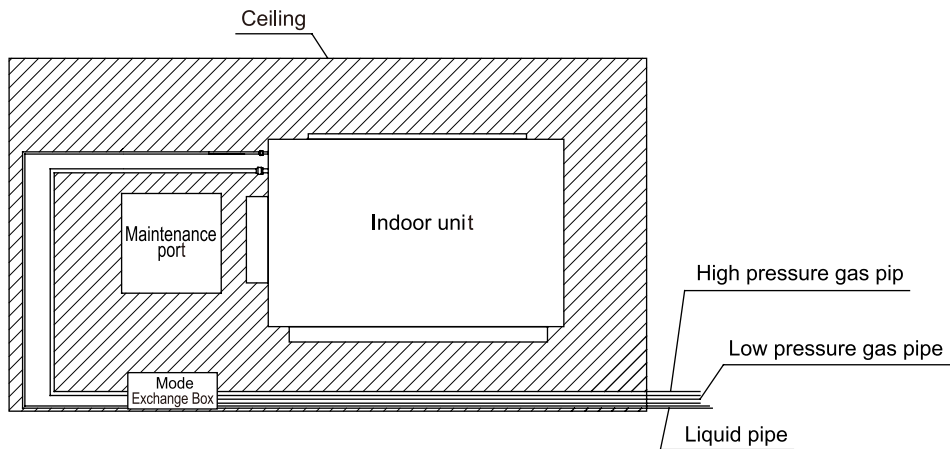
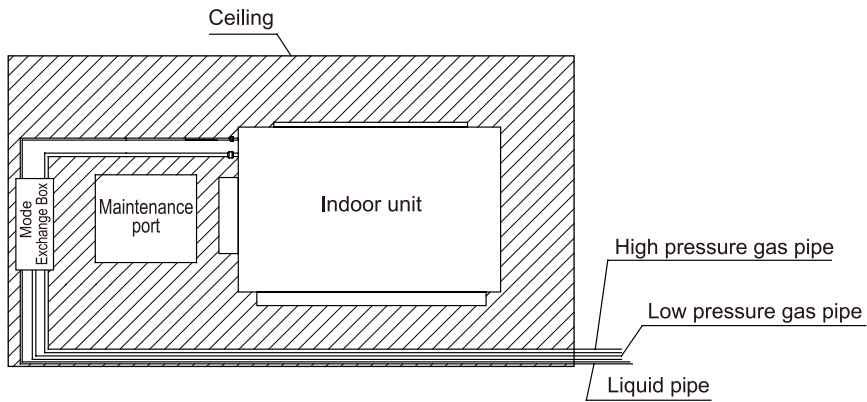
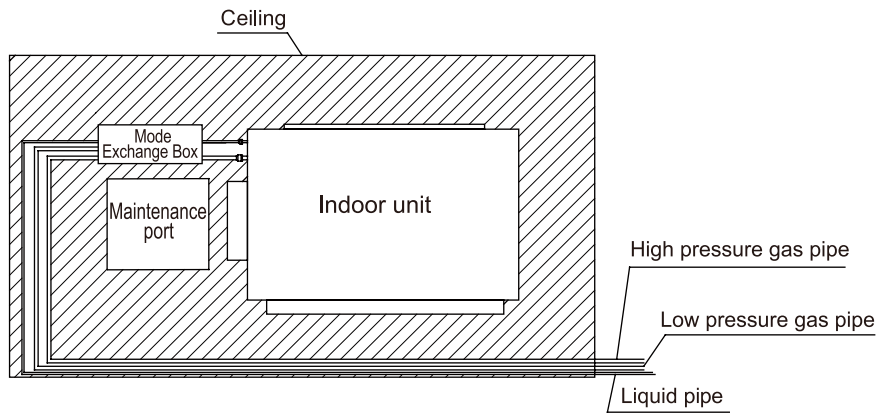

Due to the structure of installation space, the Mode Exchange Box needs a maintenance port. Please reserve another maintenance port for Mode Exchange Box.

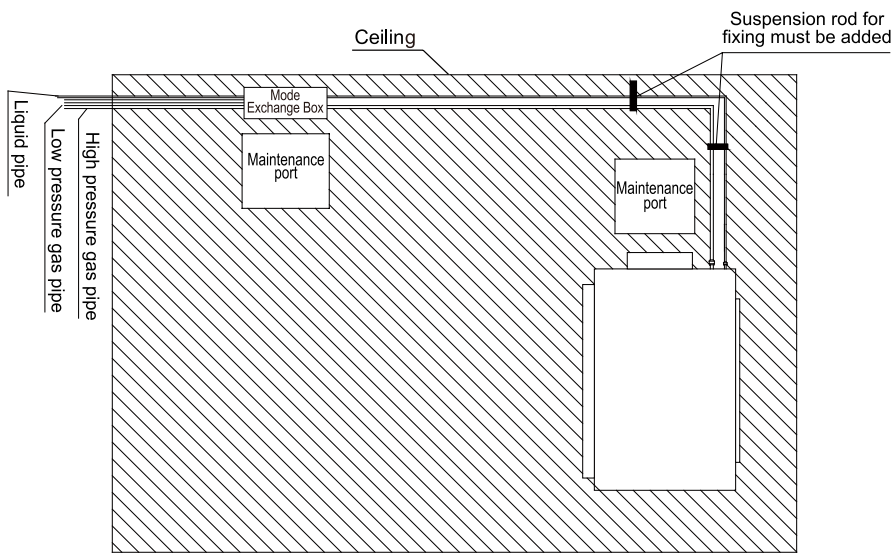

8.3 Product size and installation of mode hydro box

8.3.1 Outline size and installation hole size

Unit : mm

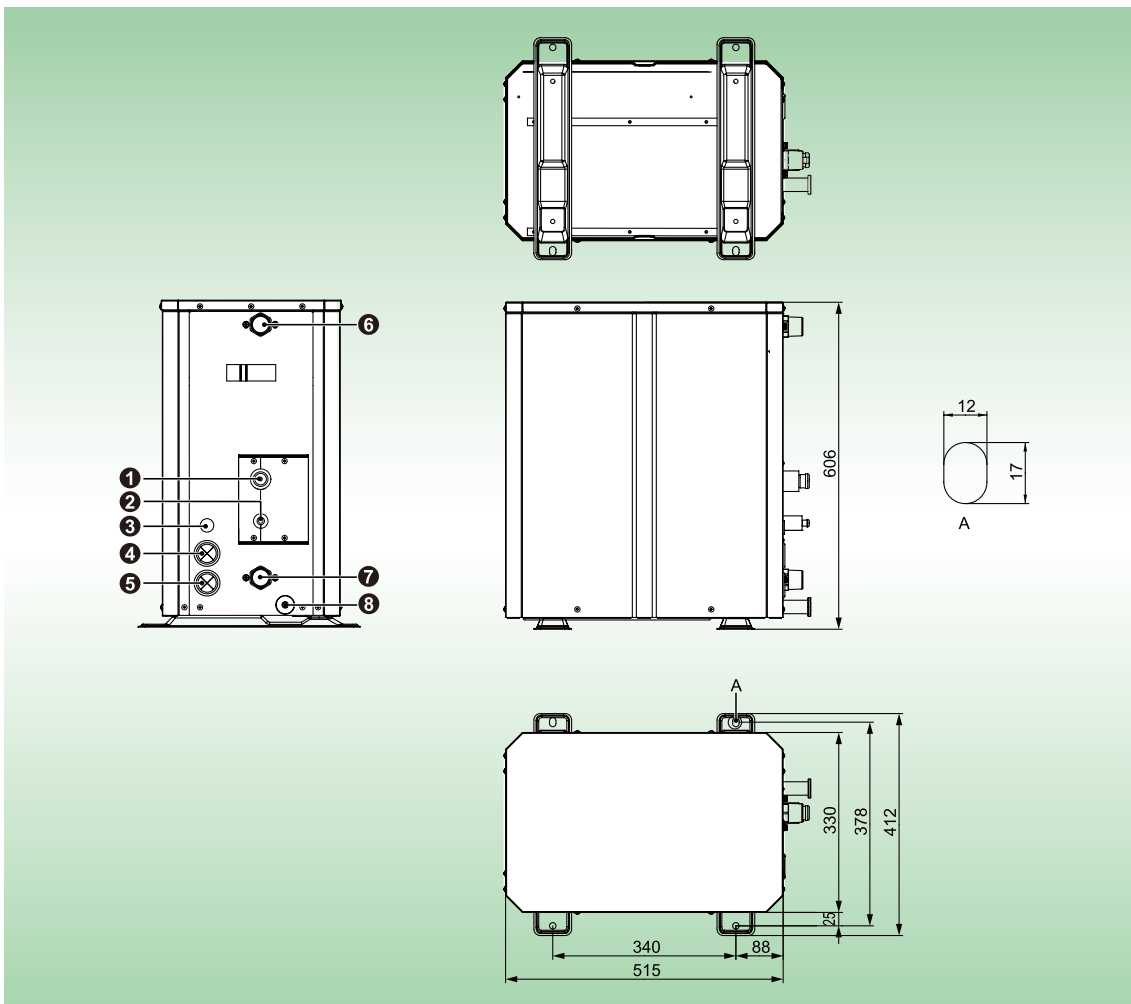

No.	Name	Pipe diameter(mm)	
		NRQR16L/A-T	NRQR30L/A-T
①	Gas pipe	Φ15.9	Φ22.2
②	Liquid pipe	Φ9.52	Φ9.52
③	Wiring passing hole	Φ15	Φ15
④	Wiring passing hole	Φ35	Φ35
⑤	Wiring passing hole	Φ35	Φ35
⑥	Water outlet	Φ25	Φ25
⑦	Water inlet	Φ25	Φ25
⑧	Drainage pipe	Φ25	Φ25

8.3.2 Select installation position

- (1) The location where the Hydro box shall be installed inside.
- (2) The location should be able to withstand the weight of Hydro box.

8.3.3 Installation space requirements

- (1) The following values are the least space for installation.
- (2) If any service area is needed for service according to field circumstance, obtain enough service space.

Unit : mm

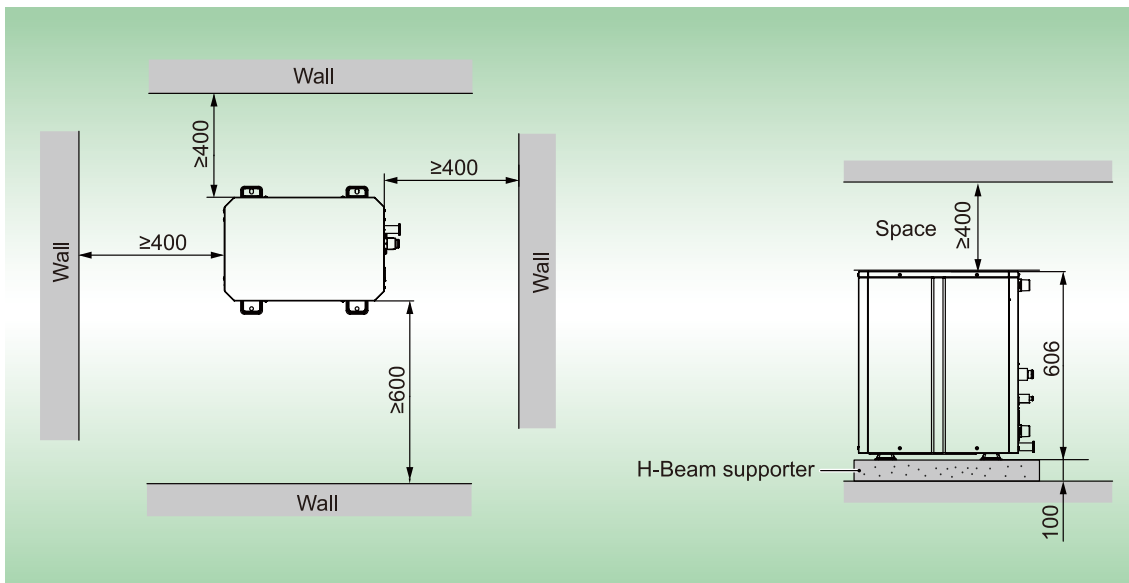

+d21+d22≤1000m;

② Length between each IDU and its nearest branch: a11,a12,b21,b22,b31,c11,d11,d21,d22≤40m

③ Difference between the pipe length from the first indoor branch to the farthest indoor unit and the pipe length from the first indoor branch to the nearest indoor unit: L12-L11≤40m.

b. Note 2: When the ODU is at the up side and the height drop exceeds 50m, please contact the engineer; when the ODU is at the lower side and the height drop exceeds 90m, please contact the engineer.

c. When the ODU is at the up side and the height drop between the IDU and ODU is more than 50m, the liquid pipe size from the ODU to the first manifold of IDU must be enlarged.

d. When the ODU is at the lower side and the height drop between the IDU and ODU is more than 40m, the liquid pipe size from the ODU to the first manifold of IDU must be enlarged.

e. When the height drop among IDUs is more than 15m, the liquid pipe size from the ODU to the first manifold of IDU must be increased.

f. When the maximum length of the main pipe from outdoor unit to the first indoor branch≥90m, then adjust the size of high pressure gas pipe, gas pipe and liquid pipe of main pipe according to the following table.

Outdoor Model	Low pressure gas pipe size(mm)	Liquid pipe size(mm)	High pressure gas pipe size(mm)
GMV-VQ224WM/C-X	No need to enlarge pipe size	No need to enlarge pipe size	No need to enlarge pipe size
GMV-VQ280WM/C-X	No need to enlarge pipe size	Φ12.7	Φ22.2
GMV-VQ335WM/C-X	Φ28.6	Φ15.9	Φ22.2
GMV-VQ400WM/C-X	Φ28.6	Φ15.9	No need to enlarge pipe size
GMV-VQ450WM/C-X	Φ31.8	Φ15.9	Φ25.4
GMV-VQ504WM/C-X	Φ31.8	Φ19.05	Φ28.6
GMV-VQ560WM/C-X	Φ31.8	Φ19.05	Φ28.6
GMV-VQ615WM/C-X	Φ31.8	Φ19.05	Φ28.6
GMV-VQ680WM/C-X	Φ31.8	Φ19.05	Φ28.6
GMV-VQ730WM/C-X	Φ38.1	Φ22.2	Φ31.8
GMV-VQ784WM/C-X	Φ38.1	Φ22.2	Φ31.8
GMV-VQ840WM/C-X	Φ38.1	Φ22.2	Φ31.8
GMV-VQ895WM/C-X	Φ38.1	Φ22.2	Φ31.8
GMV-VQ950WM/C-X	Φ38.1	Φ22.2	Φ31.8
GMV-VQ1015WM/C-X	Φ41.3	Φ22.2	Φ34.9
GMV-VQ1065WM/C-X	Φ41.3	Φ22.2	Φ34.9
GMV-VQ1119WM/C-X	Φ41.3	Φ22.2	Φ34.9
GMV-VQ1175WM/C-X	Φ41.3	Φ22.2	Φ34.9
GMV-VQ1230WM/C-X	Φ41.3	Φ22.2	Φ34.9
GMV-VQ1290WM/C-X	Φ41.3	Φ22.2	Φ34.9
GMV-VQ1345WM/C-X	Φ41.3	Φ22.2	Φ34.9
GMV-VQ1400WM/C-X	Φ44.5	Φ22.2	Φ41.3
GMV-VQ1455WM/C-X	Φ44.5	Φ22.2	Φ41.3
GMV-VQ1510WM/C-X	Φ44.5	Φ22.2	Φ41.3
GMV-VQ1565WM/C-X	Φ44.5	Φ22.2	Φ41.3
GMV-VQ1630WM/C-X	Φ44.5	Φ22.2	Φ41.3
GMV-VQ1680WM/C-X	Φ44.5	Φ22.2	Φ41.3
GMV-VQ1734WM/C-X	Φ44.5	Φ22.2	Φ41.3
GMV-VQ1790WM/C-X	Φ44.5	Φ22.2	Φ41.3
GMV-VQ1845WM/C-X	Φ44.5	Φ22.2	Φ41.3
GMV-VQ1905WM/C-X	Φ51.4	Φ25.4	Φ44.5

Outdoor Model	Low pressure gas pipe size(mm)	Liquid pipe size(mm)	High pressure gas pipe size(mm)
GMV-VQ1959WM/C-X	Φ51.4	Φ25.4	Φ44.5
GMV-VQ2015WM/C-X	Φ51.4	Φ25.4	Φ44.5
GMV-VQ2070WM/C-X	Φ51.4	Φ25.4	Φ44.5
GMV-VQ2125WM/C-X	Φ51.4	Φ25.4	Φ44.5
GMV-VQ2180WM/C-X	Φ51.4	Φ25.4	Φ44.5
GMV-VQ2245WM/C-X	Φ51.4	Φ25.4	Φ44.5
GMV-VQ2295WM/C-X	Φ51.4	Φ25.4	Φ44.5
GMV-VQ2349WM/C-X	Φ51.4	Φ25.4	Φ44.5
GMV-VQ2405WM/C-X	Φ51.4	Φ25.4	Φ44.5
GMV-VQ2460WM/C-X	Φ51.4	Φ25.4	Φ44.5

- g. If the liquid pipe is enlarged for a situation from (a) ~ (d), please do not enlarged any more.
- h. If the length between an IDU and its nearest branch is above 15m, then increase the size of the liquid pipe (only for the pipe size that is $\leq 6.35\text{mm}$) and gas pipe (only for the pipe size that is $\leq 9.52\text{mm}$) of IDU.

9.2 Connection pipe among outdoor modules

- (1) The pipe among the outdoor modules must be at the same level or tilted upwards. Otherwise, the refrigeration oil will remain in the pipe.

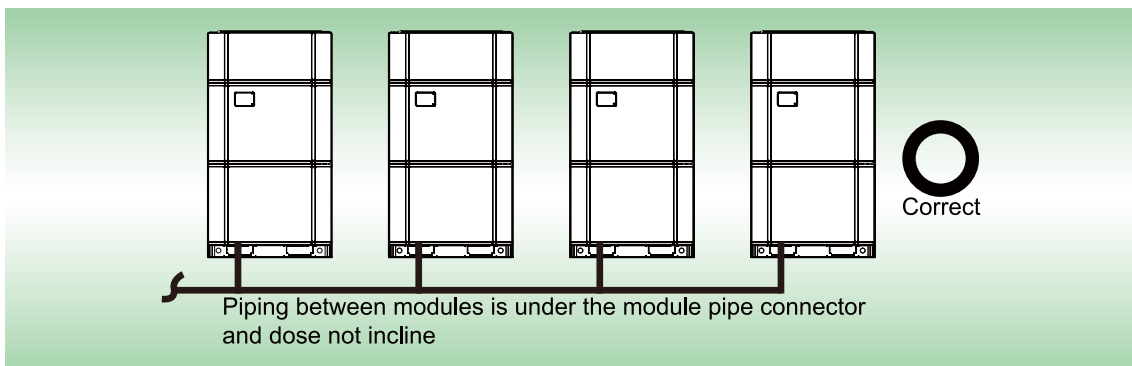
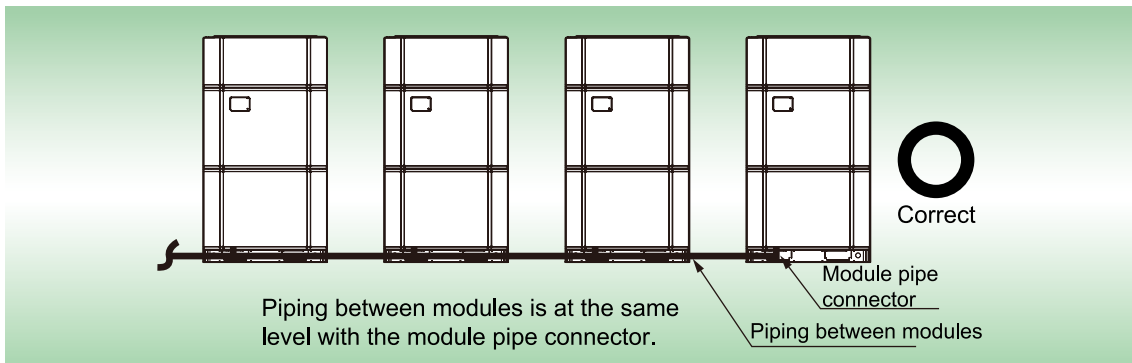

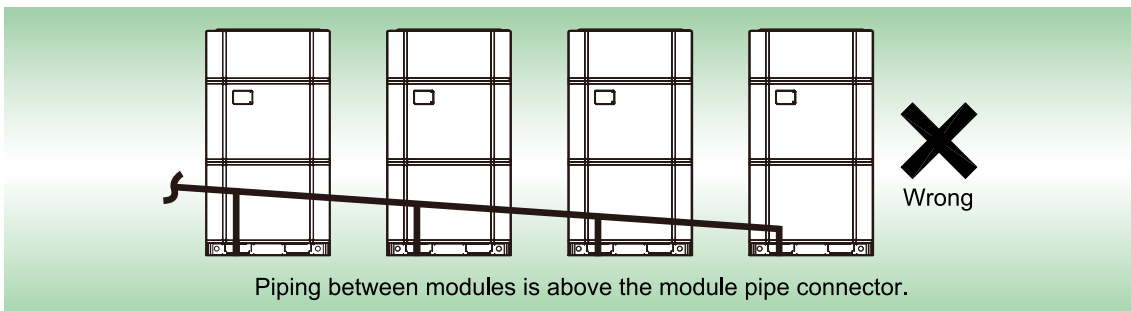
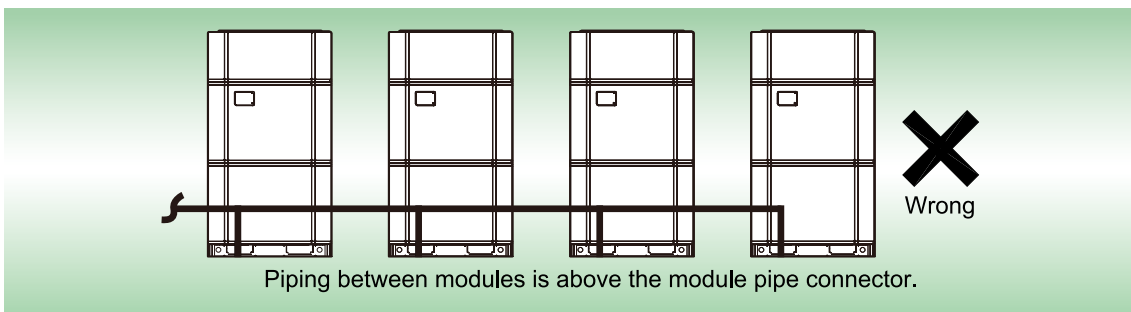
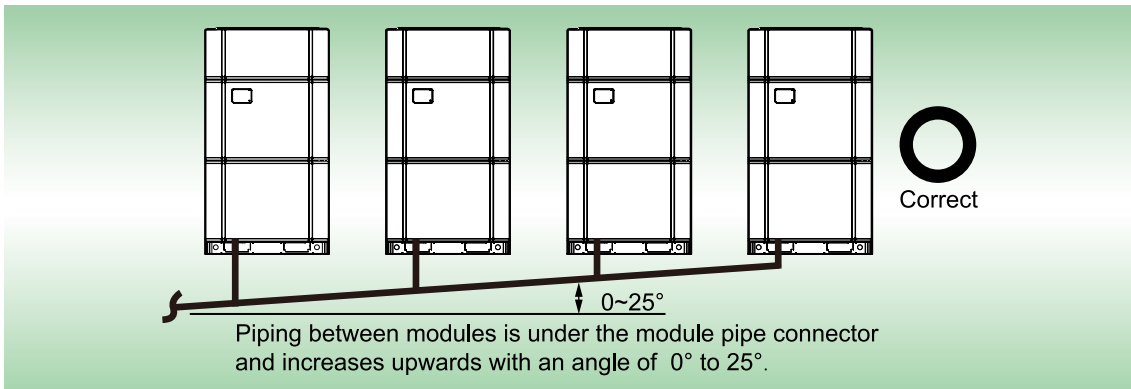

(2) The drop and the length of the pipe between the outdoor units are as follows.

Unit : m

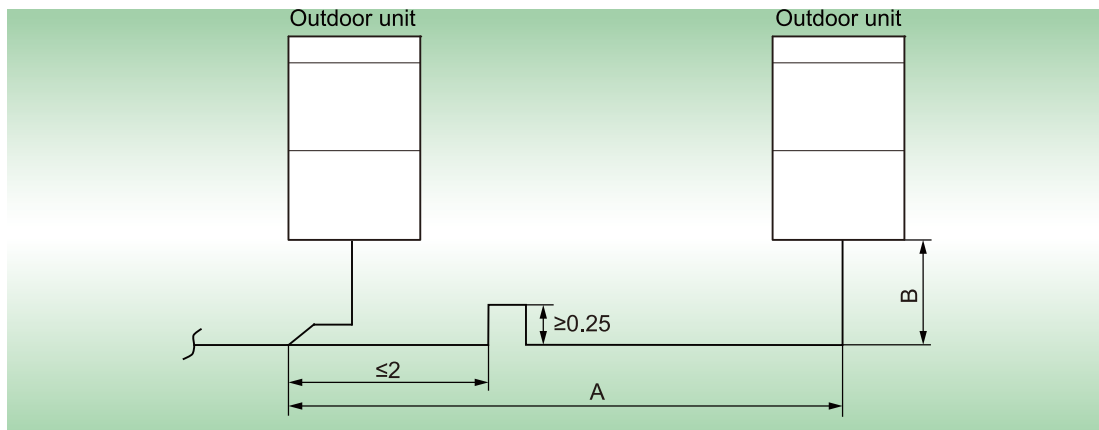

NOTE:

When the distance $A+B$ between the outdoor modules exceeds 2m, U-type oil trap should be added at low-pressure gas pipe and is no more than 2m away from the outdoor manifold, and $A+B \leq 10m$. The height drop among the outdoor units is 0m.

Basic module	Pipe between outdoor unit and the first indoor branch		
	Low pressure gas pipe (mm)	Liquid pipe (mm)	High pressure gas pipe (mm)
GMV-VQ560WM/C-X	Φ28.6	Φ15.9	Φ25.4
GMV-VQ615WM/C-X	Φ28.6	Φ15.9	Φ25.4

(4) For multi-module system

1) select appropriate branch ("M1,M2,M3") connected to outdoor module as per the pipe size of basic outdoor module. Pipe size of basic outdoor module is shown as follows:

Pipe between module and outdoor branch "M1,M2,M3"

Basic module	Size of the pipe between module and outdoor branch		
	Low pressure gas pipe (mm)	Liquid pipe (mm)	High pressure gas pipe (mm)
GMV-VQ224WM/C-X	Φ19.05	Φ9.52	Φ15.9
GMV-VQ280WM/C-X	Φ22.2	Φ9.52	Φ19.05
GMV-VQ335WM/C-X	Φ25.4	Φ12.7	Φ19.05
GMV-VQ400WM/C-X	Φ25.4	Φ12.7	Φ22.2
GMV-VQ450WM/C-X	Φ28.6	Φ12.7	Φ22.2
GMV-VQ504WM/C-X	Φ28.6	Φ15.9	Φ25.4
GMV-VQ560WM/C-X	Φ28.6	Φ15.9	Φ25.4
GMV-VQ615WM/C-X	Φ28.6	Φ15.9	Φ25.4

Selection of branch "Y1,Y2" of outdoor modules:

—	Module's capacity C (kW)	Model
Selection of branch of outdoor modules	$C \leq 96.0$	ML01R
	$96.0 < C$	ML02R

2) Size of connection pipe "M4" between branches of each basic module.

Size of connection pipe between branches of each basic module is determined by the total rated capacity of upstream modules.

Connection pipe "M4" between branches of outdoor module

Total rated capacity of upstream modules: Q (kW)	Size of connection pipe between branches of outdoor module		
	Low pressure gas pipe (mm)	Liquid pipe (mm)	High pressure gas pipe (mm)
$25.2 \geq Q$	Φ19.05	Φ9.52	Φ15.9
$28.0 \geq Q > 25.2$	Φ22.2	Φ9.52	Φ19.05
$33.5 \geq Q > 28.0$	Φ25.4	Φ12.7	Φ19.05
$40.0 \geq Q > 33.5$	Φ25.4	Φ12.7	Φ22.2
$45.0 \geq Q > 40.0$	Φ28.6	Φ12.7	Φ22.2
$68.0 \geq Q > 45.0$	Φ28.6	Φ15.9	Φ25.4
$96.0 \geq Q > 68.0$	Φ31.8	Φ19.05	Φ28.6
$135.0 \geq Q > 96.0$	Φ38.1	Φ19.05	Φ31.8
$186.0 \geq Q > 135.0$	Φ41.3	Φ19.05	Φ38.1
$Q > 186$	Φ44.5	Φ22.2	Φ41.3

3) Size of connection pipe "L" between the terminal outdoor branch and the first indoor branch
 Connection pipe "L" between outdoor unit and the first indoor branch.

Total rated capacity of upstream modules: Q (kW)	Size of connection pipe between branches of outdoor module		
	Low pressure gas pipe (mm)	Liquid pipe (mm)	High pressure gas pipe (mm)
$25.2 \geq Q$	Φ19.05	Φ9.52	Φ15.9
$28.0 \geq Q > 25.2$	Φ22.2	Φ9.52	Φ19.05
$33.5 \geq Q > 28.0$	Φ25.4	Φ12.7	Φ19.05

Total rated capacity of upstream modules: Q (kW)	Size of connection pipe between branches of outdoor module		
	Low pressure gas pipe (mm)	Liquid pipe (mm)	High pressure gas pipe (mm)
40.0≥Q>33.5	Φ25.4	Φ12.7	Φ22.2
45.0≥Q>40.0	Φ28.6	Φ12.7	Φ22.2
68.0≥Q>45.0	Φ28.6	Φ15.9	Φ25.4
96.0≥Q>68.0	Φ31.8	Φ19.05	Φ28.6
135.0≥Q>96.0	Φ38.1	Φ19.05	Φ31.8
186.0≥Q>135.0	Φ41.3	Φ19.05	Φ38.1
Q>186	Φ44.5	Φ22.2	Φ41.3

4) Branch selection of mode exchange box

Select branch of mode exchange box as per total capacity of downstream indoor unit(s). Please refer to the following table.

Model selection for branch "A1,A2" of mode exchange box:

R410A refrigerant system	Total capacity of the downstream indoor unit X (kW)	Model
Y-Type Branch Pipe	X≤5.0	FQ01Na/A
	5.0<X≤25.2	FQ02Na/A
	25.2<X≤28.0	FQ03Na/A
	28.0<X≤68.0	FQ04Na/A
	68.0<X≤96.0	FQ05Na/A
	96.0<X≤135.0	FQ06Na/A
	135.0<X	FQ07Na/A

5) Piping size among upstream branches of heat pump mode exchange box ("n1,n2,n3,n4")

Piping requirement among upstream branches of mode exchange box ("n1,n2,n3,n4")

Total rated capacity of downstream indoor units: X (kW)	Size of connection pipe between branches of mode exchange box		
	Low pressure gas pipe (mm)	Liquid pipe (mm)	High pressure gas pipe (mm)
X≤5.0	Φ12.7	Φ6.35	Φ12.7
5.0<X≤14.2	Φ15.9	Φ9.52	Φ12.7
14.2<X≤25.2	Φ19.05	Φ9.52	Φ15.9
25.2<X≤28.0	Φ22.2	Φ9.52	Φ19.05
28.0<X≤33.5	Φ25.4	Φ12.7	Φ19.05
33.5<X≤40.0	Φ25.4	Φ12.7	Φ22.2
40.0<X≤45.0	Φ28.6	Φ12.7	Φ22.2
45.0<X≤68.0	Φ28.6	Φ15.9	Φ25.4
68.0<X≤96.0	Φ31.8	Φ19.05	Φ28.6
96<X≤135	Φ38.1	Φ19.05	Φ31.8
135<X≤186	Φ41.3	Φ19.05	Φ38.1
186<X≤246	Φ44.5	Φ22.2	Φ41.3

6) Piping size among downstream branches of mode exchange box "a,h"

Total rated capacity of downstream indoor units: X (kW)	Piping size among downstream branches of mode exchanger	
	Gas pipe (mm)	Liquid pipe (mm)
X≤2.8	Φ9.52	Φ6.35
2.8<X≤5.0	Φ12.7	Φ6.35
5.0<X≤14.2	Φ15.9	Φ9.52
14.2<X≤16	Φ19.05	Φ9.52

7) Branch selection of downstream indoor unit of mode exchange box ("B1,B2,B3")

R410A refrigerant system	Total rated capacity of downstream indoor units: X (kW)	Model
Y-type branch	X≤14.2	FQ01A/A
	14.2<X≤28	FQ01B/A

8)Piping size between mode exchange box and downstream indoor unit (" b,c,d,g")

Total rated capacity of downstream indoor units: X (kW)	Piping size between mode exchange box and downstream indoor unit	
	Gas pipe (mm)	Liquid pipe (mm)
$X \leq 2.8$	Φ9.52	Φ6.35
$2.8 < X \leq 5.0$	Φ12.7	Φ6.35
$5.6 < X \leq 14.2$	Φ15.9	Φ9.52
$14.2 < X \leq 16$	Φ19.05	Φ9.52

9)Piping between indoor branch and indoor unit ("e,f,i,j,k")

Size of connection pipe between indoor branch and indoor unit should be consistent with the connection pipe of indoor unit.

Piping between indoor branch and indoor unit ("e,f,i,j,k")



Rated capacity of indoor units C(kW)	Size of connection pipe between indoor branch and indoor unit	
	Gas pipe (mm)	Liquid pipe (mm)
$C \leq 2.8$	Φ9.52	Φ6.35
$2.8 < C \leq 5.0$	Φ12.7	Φ6.35
$5.0 < C \leq 14.2$	Φ15.9	Φ9.52
$14.2 < C \leq 16$	Φ19.05	Φ9.52

10)Piping between indoor branches ("l")

Rated capacity of the downstream indoor units C(kW)	Size of connection pipe between indoor branches	
	Gas pipe (mm)	Liquid pipe (mm)
$C \leq 2.8$	Φ9.52	Φ6.35
$2.8 < C \leq 5.0$	Φ12.7	Φ6.35
$5.0 < C \leq 14.2$	Φ15.9	Φ9.52
$14.2 < C \leq 16$	Φ19.05	Φ9.52

9.4 Connecting method for indoor unit with capacity of over 16kW

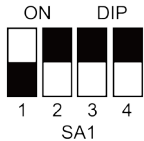
When connecting to the indoor unit with capacity of over 16kW, it is not allowed to connect with only one branch; it must use two branches controlled by the same mainboard for parallel connection.

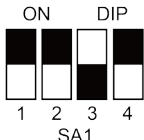
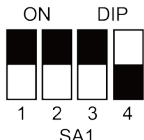
Parallel connection	Dial code	Indoor unit communication connection for mode exchange box	Remarks
Indoor unit No.1 and No.2		"1D1 1D2" or "2D1 2D2"	Parallel connection can be conducted only as the combination of this table; it is not allowed to otherwise connect. Note that after the connection, manually set the SA1 dial code of corresponding mainboard, and dial the code as shown in the table.
Indoor unit No.2 and No.3		"2D1 2D2" or "3D1 3D2"	
Indoor unit No.3 and No.4		"3D1 3D2" or "4D1 4D2"	
Indoor unit No.1 and No.2 Indoor unit No.3 and No.4		"1D1 1D2" or "2D1 2D2" and "3D1 3D2" or "4D1 4D2"	

Connecting method is as shown in the picture:

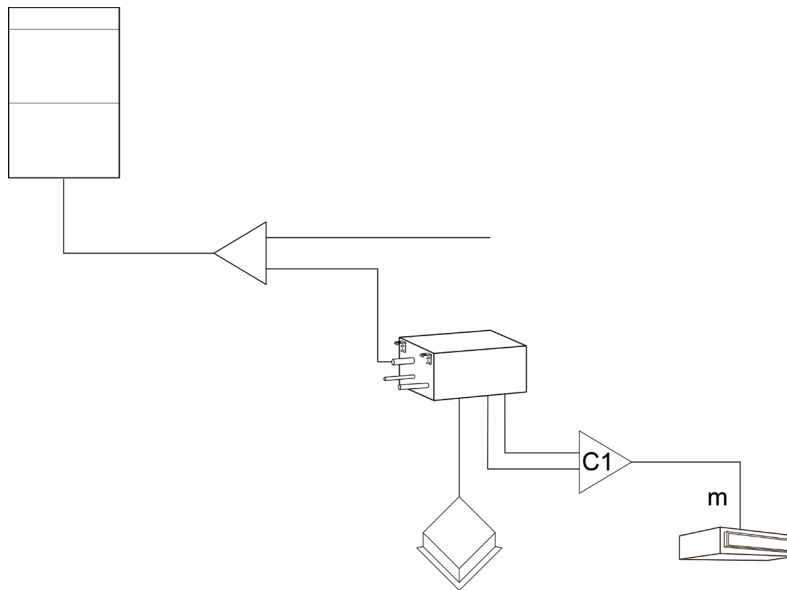

9.5 Branch selection of indoor unit of mode exchange box ("C1")

R410A refrigerant system	Capacity of downstream indoor units: X/ kW	Model
Y-type branch	$16 < X \leq 28$	FQ01B/A

9.6 Piping size between mode exchangebox and downstream indoor unit ("m")

Size of connection pipe between indoor branch and indoor unit should be consistent with the connection pipe of indoor unit.

Piping between indoor branch and indoor unit ("m")

Rated capacity of indoor units: C(kW)	Size of connection pipe between indoor branch and indoor unit	
	Gas pipe(mm)	Liquid pipe(mm)
$16 < C \leq 22$	$\Phi 19.05$	$\Phi 9.52$
$22 < C \leq 28$	$\Phi 22.2$	$\Phi 9.52$

9.7 Refrigerant Pipe Connection between Hydro box and Mode exchange box

(1) Refrigerant Pipe Connection between 16 kW Hydro box and Mode exchanger box

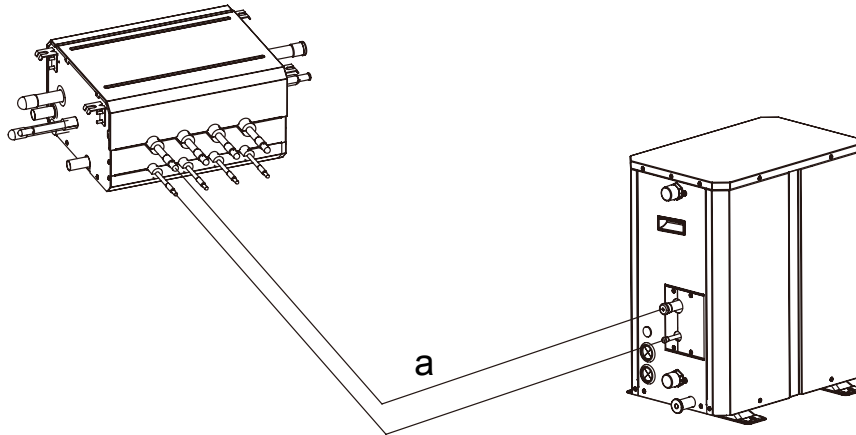

(2) Refrigerant Pipe Connection between 30 kW Hydro box and Mode exchanger box

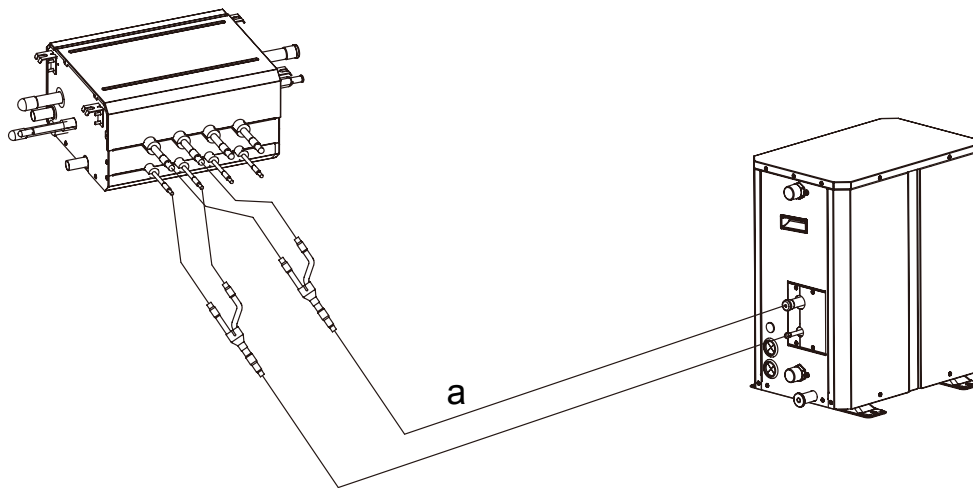

NOTES:

- a. Refrigerant pipe length between mode exchange box and hydro box $a \leq 10\text{m}$.
- b. When 2 mode exchange branches are connected in parallel with a 30kW hydro box, two adjacent branches must be selected;
- c. Please refer to the manual of mode exchange for branch linkage setting and communication line setting.

9.8 Selection of branches between mode exchange box downstream and hydro box

R410A Refrigerant System	Total capacity of downstream Hydro box X(kW)	Model
Y-type Manifold	< 22.4	-
	$22.4 \leq X \leq 30.0$	FQ01B/A

10 COMMUNICATION SYSTEM INTRODUCTION

GMV6HR DC Inverter VRF system adopts CAN communication network, manual DIP switch and polarity to distinguish communication cord is needless for IDU and just set function DIP for ODU.

10.1 Connection method of communication cord terminal

The connection of all communication is fixed by screws.

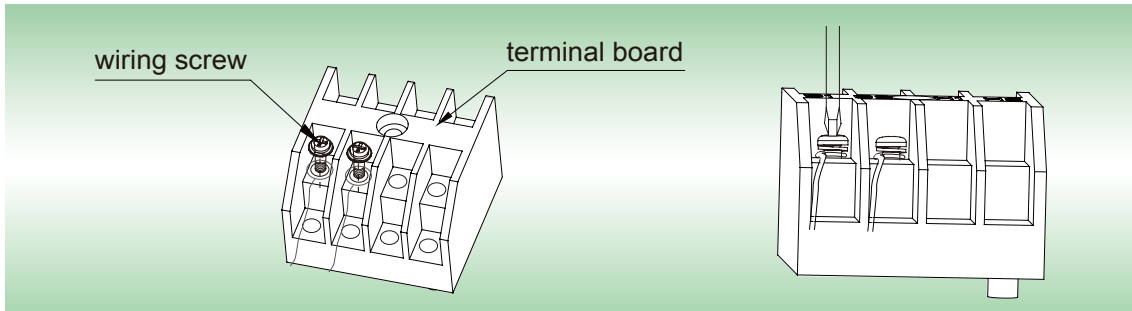

10.2 Material and wiring method of communication cord

10.2.1 Communication material

If the air conditioning unit is installed in a place with strong electromagnetic interference, the communication line between the indoor unit and the wired controller must adopt shielded wires; the communication line between indoor units (between indoor unit and outdoor unit) must use the shielded twisted pairs.

- (1) Selection of communication wire between outdoor unit and mode exchange box, among mode exchange boxes, and mode exchange box and indoor unit respectively.

Wire type	Length of communication wire between indoor unit and another indoor/outdoor unit(m)	Wire diameter (mm ²)	Wire standard	Remark
Light / ordinary PVC sheathed twisted copper core cord	L ≤ 1000	≥ 2 × 0.75	IEC 60227-5:2007	If the wire diameter is increased to 2 × 1mm ² , the length of communication line can't be increased, while the length of the communication line can't be more than 1500m.
Shielded light/ordinary PVC sheathed twisted copper core cord	L ≤ 1000	≥ 2 × 0.75	IEC 60227-5:2007	When the installation environment of the unit is in strong magnetic or strong interference, the shielded wires shall be used.

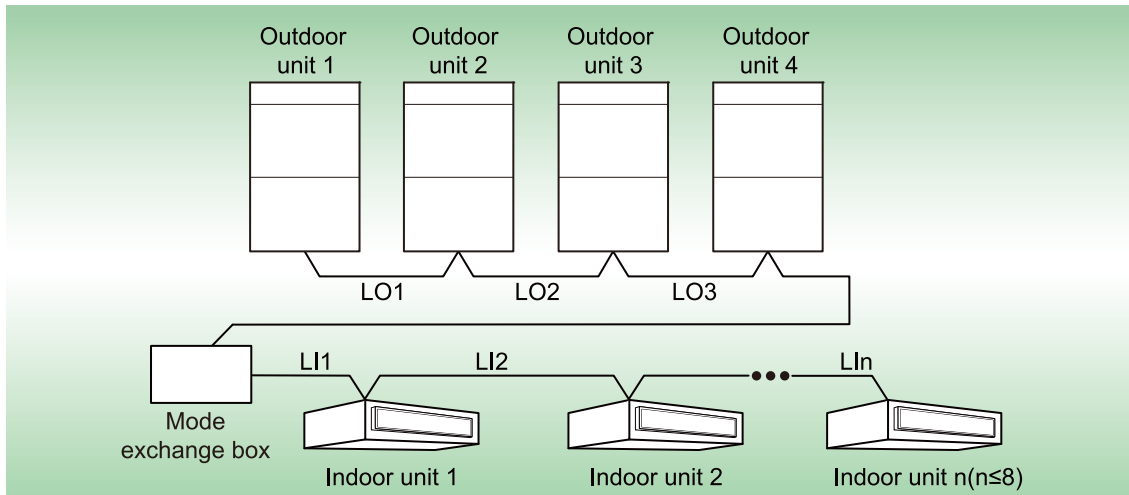

(2) Selection of communication line between hydro box and mode exchange box

Material Type	Total Length L (m) of Communication Cable between Indoor Unit and Indoor (Outdoor) Unit	Wire size (mm ²)	Material Standard	Remarks
Light/Ordinary polyvinyl chloride sheathed cord. (60227 IEC 52 /60227 IEC 53)	$L \leq 1000$	$\geq 2 \times 0.75$	IEC 60227-5	1. If the wire diameter is enlarged to $2 \times 1 \text{ mm}^2$, the total communication line length can reach 1500m. 2. The cord shall be Circular cord (the cores shall be twisted together). 3. If unit is installed in places with intense magnetic field or strong interference, it is necessary to use shielded wire.

(3) Selection of communication line between indoor unit and wired controller

Wire type	Length of communication line between indoor unit and wired controller(m)	Wire diameter (mm ²)	Wire standard	Remark
Light / ordinary PVC sheathed twisted copper core cord	$L \leq 250$	$2 \times 0.75 \sim 2 \times 1.25$	IEC 60227-5:2007	The length of communication line can't exceed 250m.
Shielded light/ordinary PVC sheathed twisted copper core cord	$L \leq 250$	$2 \times 0.75 \sim 2 \times 1.25$	IEC 60227-5:2007	When the installation environment of the unit is in strong magnetic or strong interference, the shielded wires shall be used.

The connection between the indoor unit and the wired controller is shown as below:

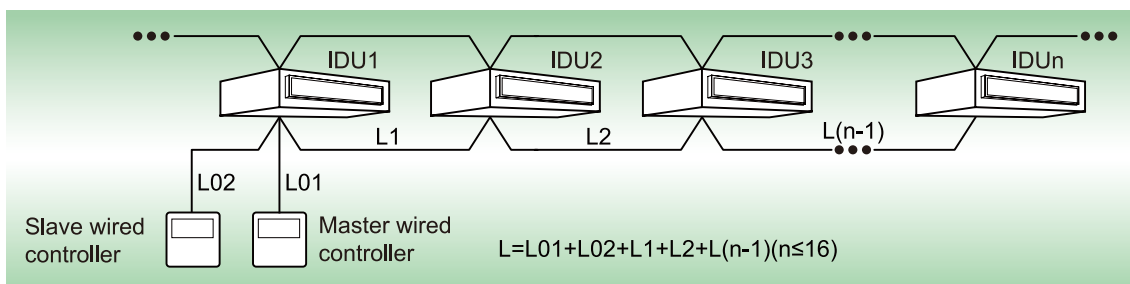

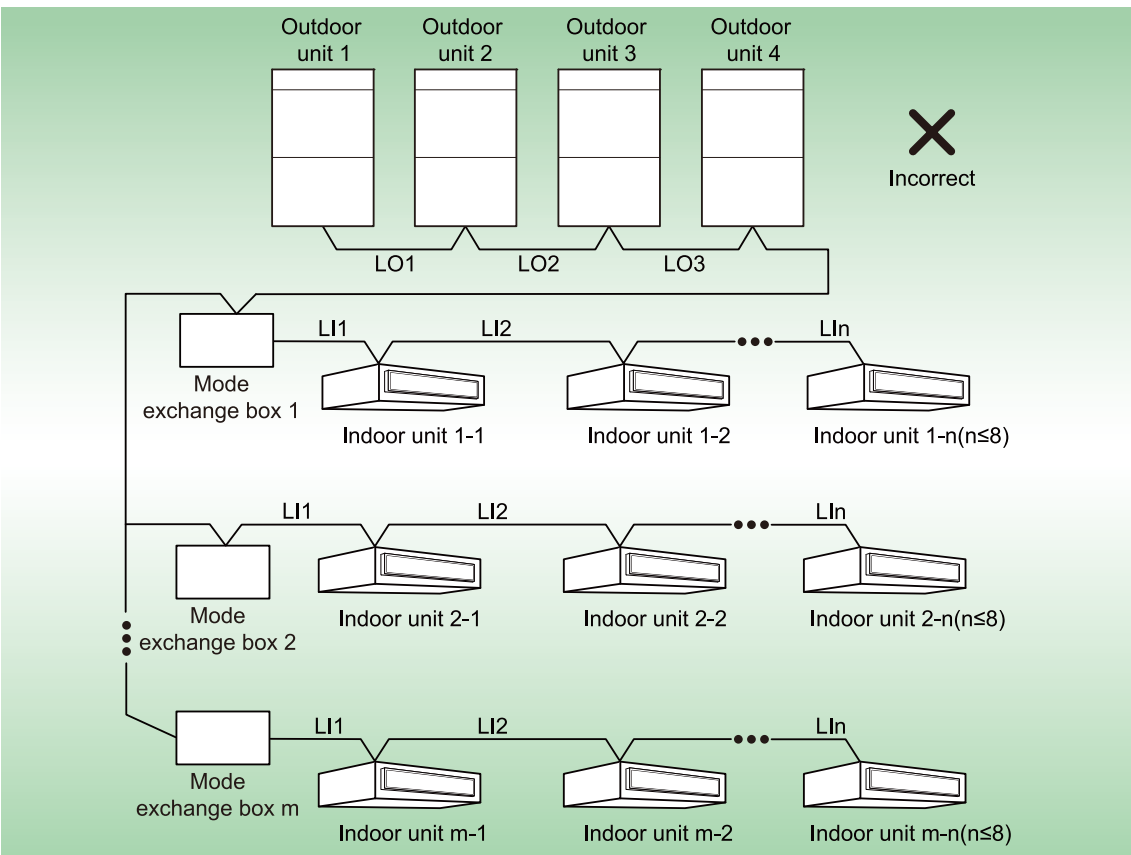
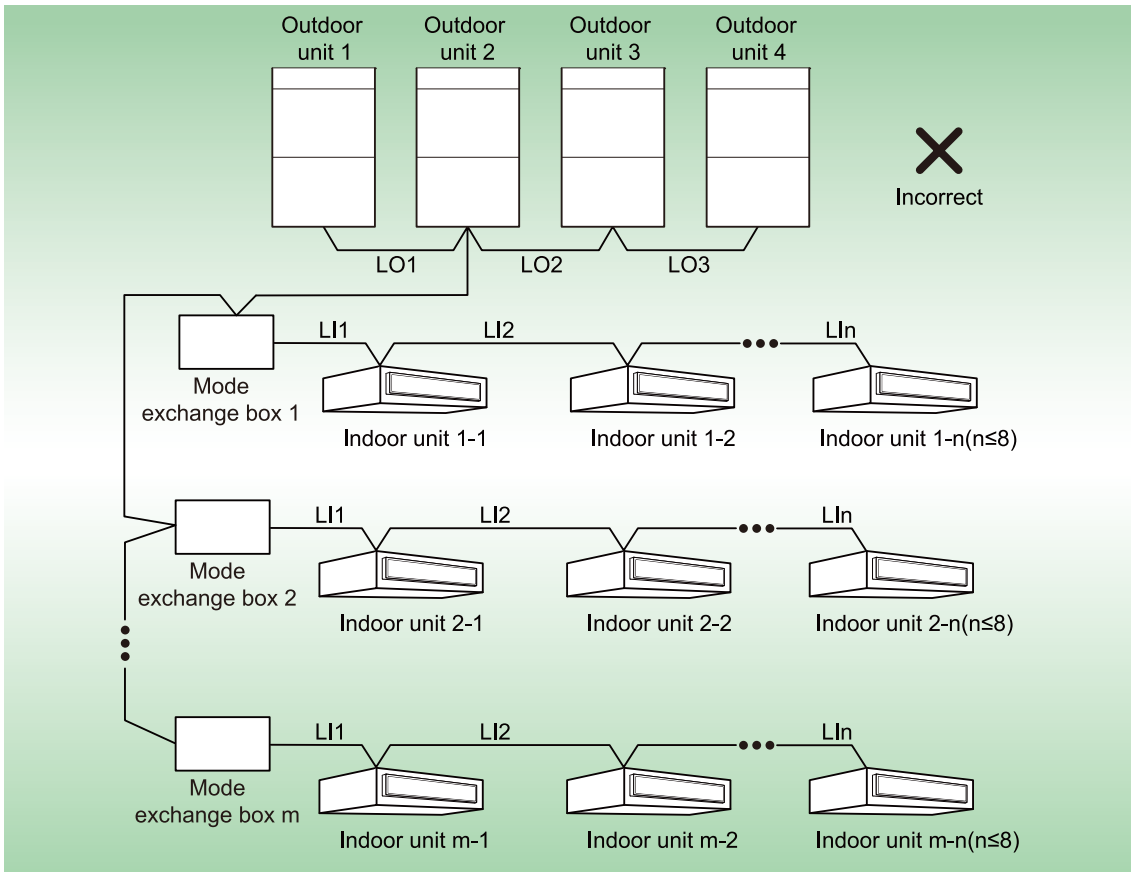

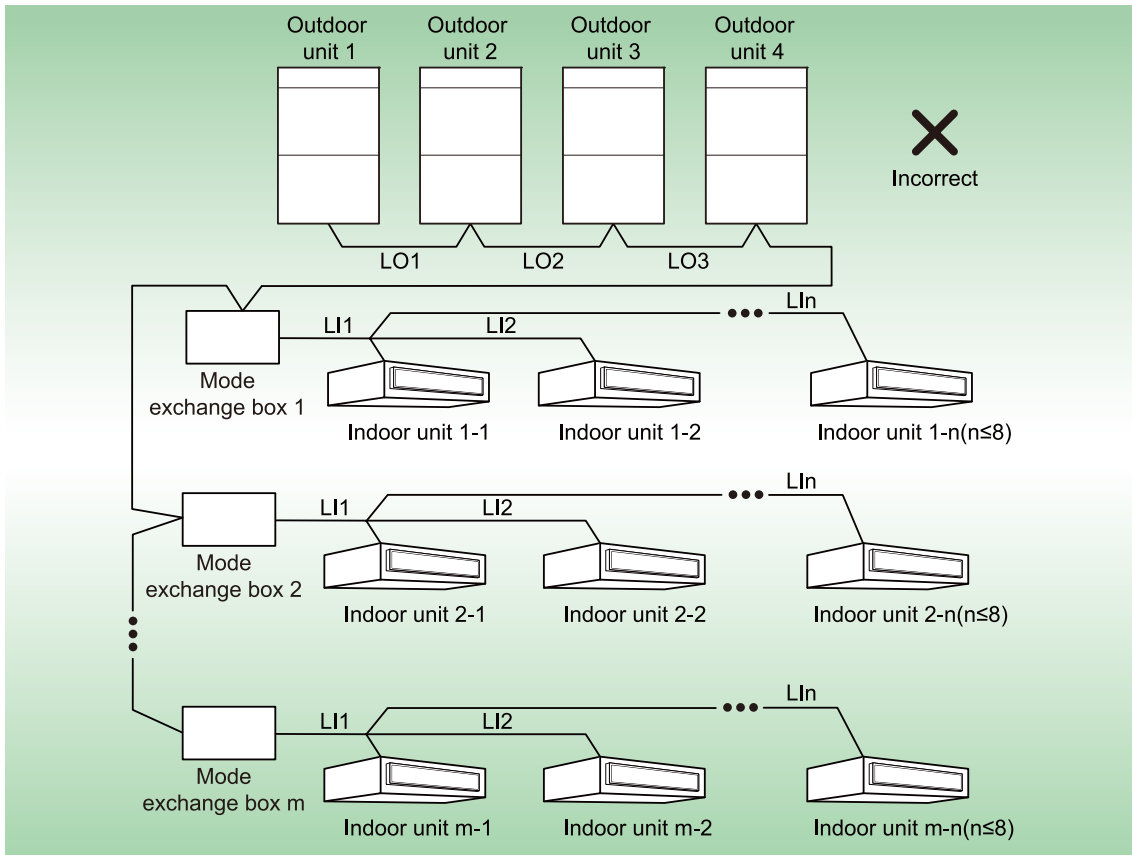

(2) If a communication wire is not long enough and needs to be connected with another wire by peeling away its outer layer, crimp connection or soldering connection must be adopted.

10.3 Connection Methods and Procedure of Communication System

10.3.1 Communication connection between the indoor unit and outdoor unit

Communication between indoor unit, mode exchange box and outdoor units is connected via terminal D1/D2 on the communication wiring board. Connection method for single-module and multi-module systems is shown below:

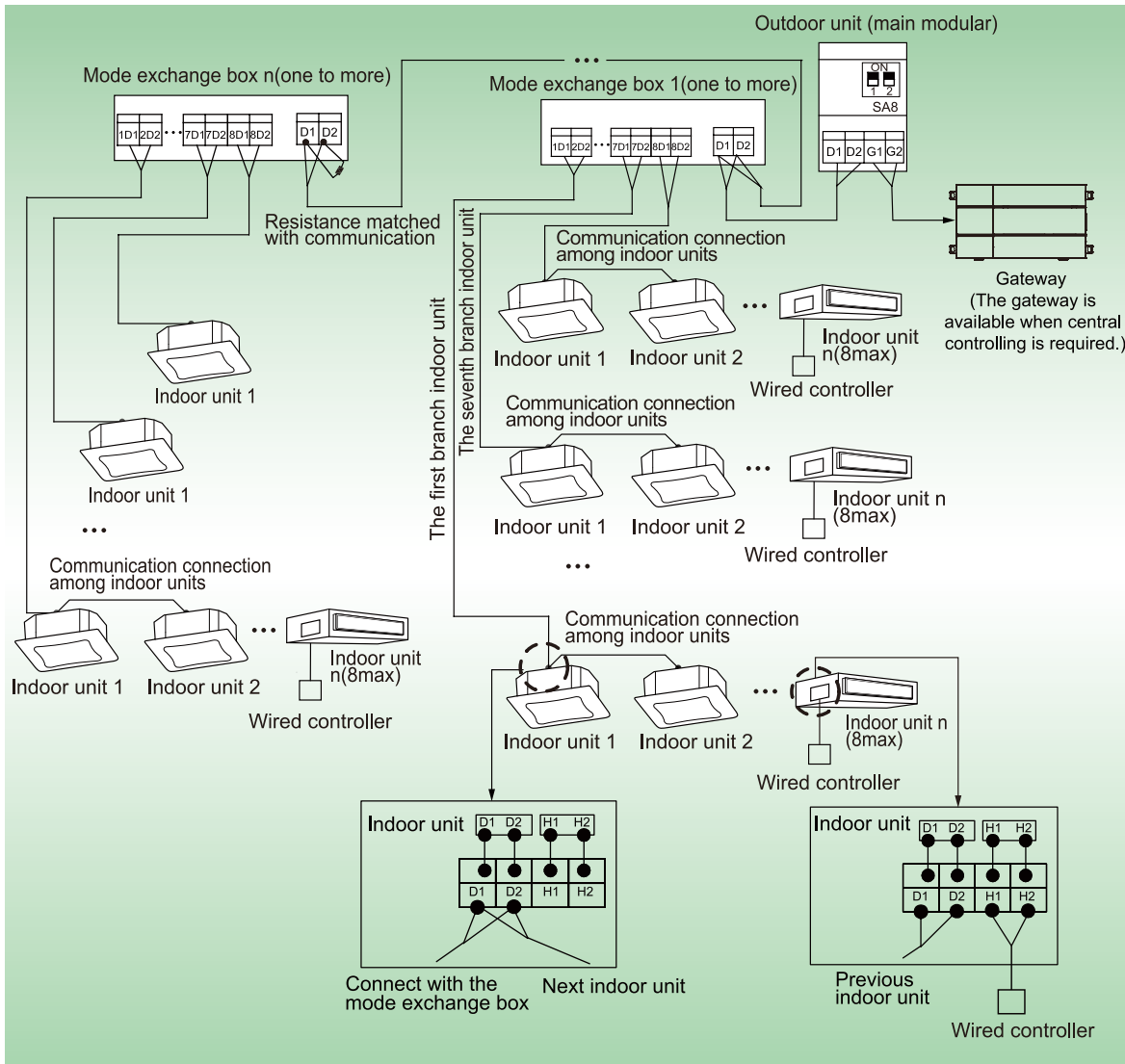

NOTES:

- As for modular indoor unit, if there are multiple outdoor unit modules, the master module must be the first outdoor unit module on the communication line, and it must not connect to the indoor unit (main module is set by SA8 of indoor unit main board).
- As for modular outdoor unit, if there are multiple outdoor unit modules, the indoor unit must be connected to the last outdoor unit's slave module (slave unit is set by SA8 of indoor unit main board).
- The communication line and the power cord must be routed separately to avoid interference.
- The communication line must be of suitable length and must not be connected.
- The mode exchange box must be connected in series and the last mode exchange box must be

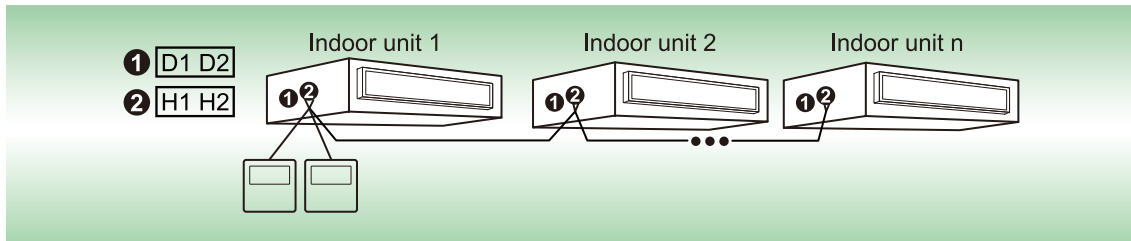

Two wired controllers control multiple IDU

When two wired controllers control multiple IDUs, the wired controller can be connected to any one IDU, provided that the connected IDU is of the same series. Meanwhile, one and only one of the wired controllers must be set as a slave controller. At most 16 IDUs can be controlled by wired controllers and the connected IDUs shall be within a same IDU network.

No matter when unit is turned on or off, slave controller can be set.

How to set a slave controller: hold "function" button on the designated controller for 5s, and temperature zone displays C00. Continue holding "function" button for 5s and setting screen of controller parameter will come out. Default temperature zone displays P00.

Press ▲ button or ▼ button to select parameter code P13. Press "mode" button to switch to setup of parameter values. Then the parameter value will blink. Press ▲ button or button ▼ to select code 02. And then press "confirm/cancel" to finish setting.

Press "confirm/cancel" to return to the previous display until you exit from the setup of parameter values.

Below are user's parameter settings:

Parameter code	Parameter name	Parameter scope	Default value	Remark
P13	Set up address for wired controller	01: master wired controller 02: slave wired controller	01	When 2 wired controllers control one or more IDUs, they shall have different addresses. Slave wired controller (02) can't set up units' parameters except its address.

10.3.3 Connection method between duct type IDU and dash receiver

If remote dash receiver is needed for the duct type IDU, it shall be connected through DISP1 and DISP2 in the master board of IDU

IDU type	Model of remote dash receiver	Model of connection wire	Corresponding to the interface of IDU main board
Duct type IDU	JS05	Connection wire among plates (17-core)	DISP1 (connect to 8-core interface) DISP2 (connect to 9-core interface)

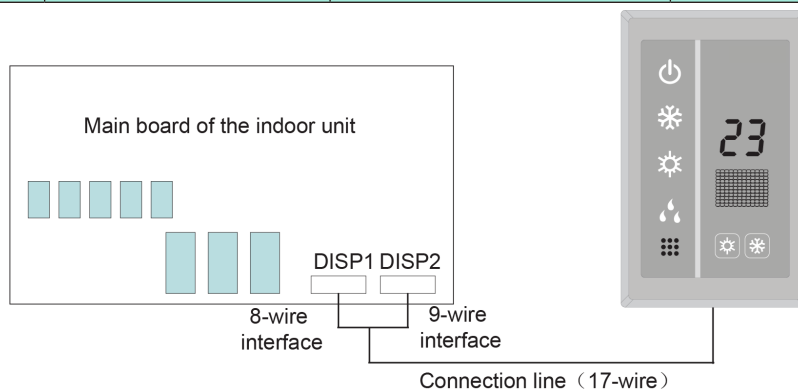

NOTES:

- a. Wired controller and remote dash receiver can be used at the same time.

- b. When selecting remote dash receiver, select the remote controller.
- c. Not suitable for GMV-ND80~140PLS/C-T.

11 EXTERNAL ELECTRICAL WIRING DIAGRAM

11.1 External wiring interface

External wiring interface	Power supply	Quantity	5
		Logo	L1 L2 L3 N PE
	IDU/ODU communication	Quantity	2
		Logo	D1 D2
	Central control	Quantity	2
		Logo	G1 G2

11.2 External wiring

Each unit should be equipped with a circuit breaker for short circuit and abnormal overload protection. The circuit breaker is normally closed.

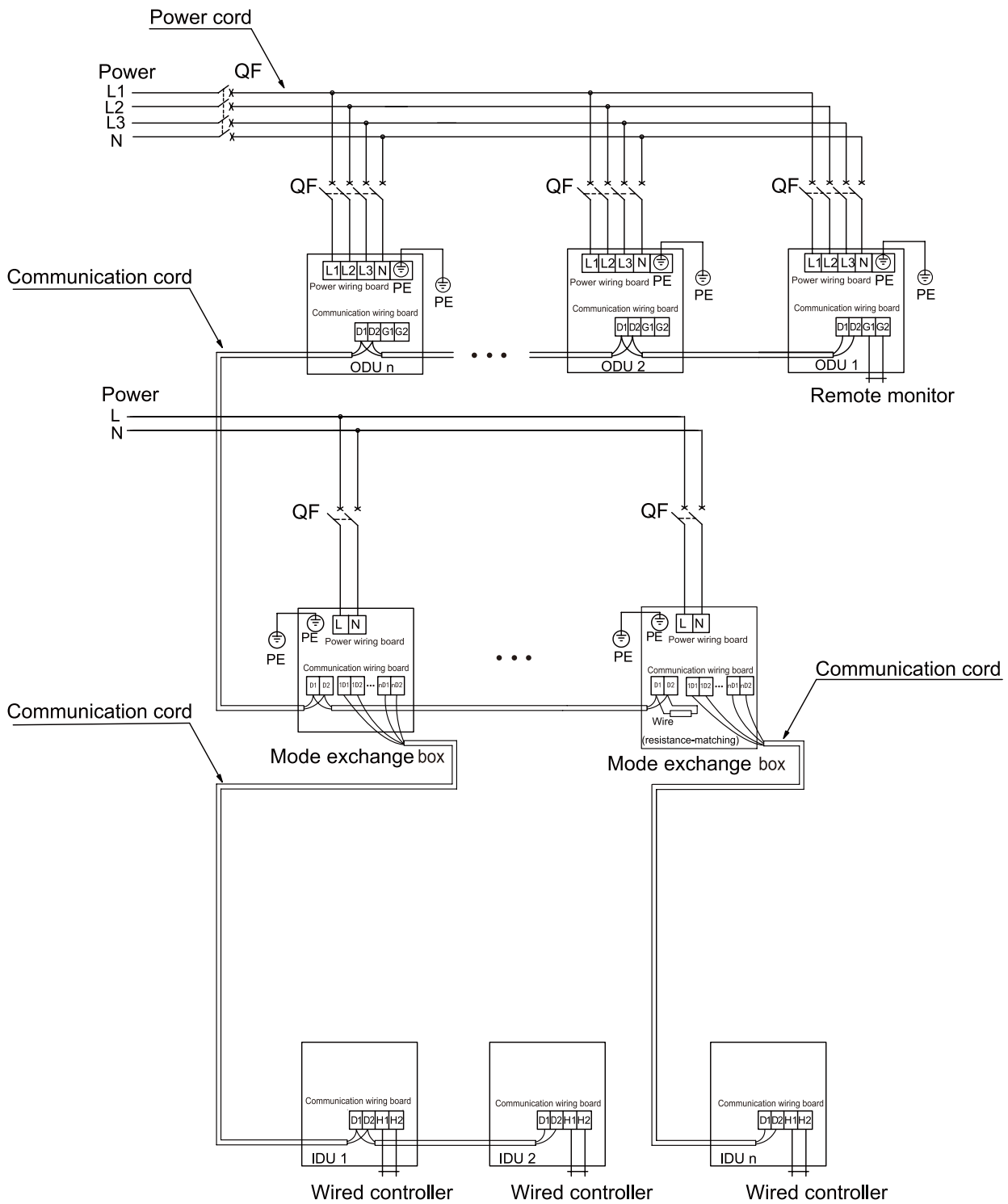

NOTES:

The maximum outdoor unit quantity "n" is decided by the combination from of outdoor unit.

Modular combination of outdoor unit subjects to combinations that is currently available.

13 NOTICES

13.1 Safety notices

- (1) The unit should not be installed in places with high pH, high voltage fluctuations, vehicles and ships.
- (2) Do not touch the fins of the heat exchanger. Improper touch can cause damage.
- (3) Do not mix other substance apart from refrigerant in the refrigerant circuit during installing or moving the unit, and do not leave any air in the pipe. If air or other substances are mixed, the system pressure will rise, the compressor will burst and damage will occur.
 - 1) Don't seal the non-specified refrigerant when installing or moving the unit, otherwise, it might cause poor operation, malfunction, mechanical breakdown, etc, or even cause major safety accident.
 - 2) When moving the unit or repairing the recycled refrigerant, be sure to use the pressure gauge. Conduct the cooling operation first, then completely shut down the valve (liquid valve) at high pressure side. When the pressure gauge display 0 ~ 0.05MPa, completely shut down the valve (gas valve) at low pressure side and immediately stop running and cut off the power.
 - 3) When recovering the refrigerant, please make sure to completely shut down the liquid valve and gas valve, and cut off the power before dismantling the connection pipe; otherwise, there will be air intrusion, resulting in pressure rise of the system, if the compressor is burst, it will cause damages.
 - 4) When installing the unit, make sure that the connection pipe is securely connected before starting the compressor. If the compressor is started before the connection pipe is connected and when the cut off valve is started, there will be air intrusion, resulting in pressure rise of the system, if the compressor is burst, it will cause damages.
 - 5) Wiring between indoor and outdoor units must be correctly connected with the specified wires, and the wiring terminal shall not be affected by external forces. Poor connection or fixing might cause fire accident.
 - 6) No connection is allowed in the middle of the wire. When the length of the connecting wire is not enough, please contact the designated service store to re-equip a dedicated wire of sufficient length.

13.2 Notices on using refrigerant

- (1) AC project designers and installers shall obey the local laws and regulations on the safety requirement of the usage and leakage of refrigerant.
- (2) The multi VRF unit adopts R410A refrigerant. When installing in the space with people, the refrigerant amount shall not exceed the max.allowable concentration. Otherwise, suffocation will occur. For example, the max.allowable concentration for refrigerant of European safety standard and regulation is 0.44kg/m³.

$$\text{Max. refrigerant charge(kg)} = \text{Room volume(m}^3\text{)} \times \text{max. allowable concentration(kg/m}^3\text{)}$$

$$\text{Refrigerant charge(kg)} = \text{Adding quantity of refrigerant(kg)} + \sum \text{ex-factory charge of ODU(kg)}$$

$$\text{Refrigerant charge} \leq \text{Max. refrigerant charge}$$
- (3) When refrigerant charge has exceeded the max.refrigerant charge, re-design the refrigeration system and divide the refrigeration system to several refrigeration systems of small volume, or add corresponding ventilation measures and alarms.

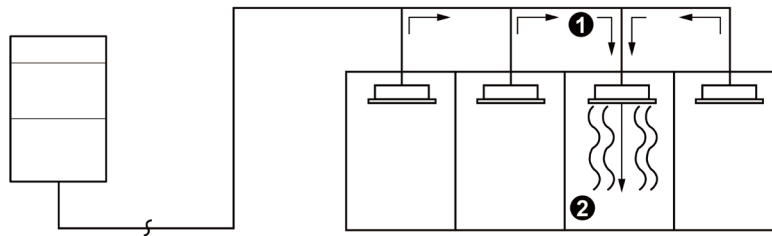

- ❶ Flow direction of refrigerant leakage
- ❷ Room for refrigerant leakage.

Since the concentration of refrigerant is greater than that of air, pay attention to the spaces where the refrigerant may residue, for example, the basement.

14 OPTIONAL COMPONENTS

—		Model	Remarks
Manifold	Outdoor unit	ML01/A	For the model selection method, see the part of pipeline selection.
	Indoor unit	FQ01A/A, FQ01B/A, FQ02/A, FQ03/A, FQ04/A	—
Remote controller		YAP1F	Duct-type indoor unit Optional (Wall-Mounted indoor unit , the air Cassette, Floor Ceiling Standard)
Remote controller for debugging		YV1L1	With the debugging function, used to set functions of the indoor unit
Classic wired controller		Wired controller XK46	Applicable to the air Cassette, Floor Ceiling, Wall-Mounted indoor unit Optional (Duct-type, Concealed Floor Standing Type indoor unit Standard)
Wired controller		Wired controller XK79	With the access control function
Wired controller		Wired controller XE70-33/H	—
Centralized controller		CE52-24/F(C)	—
E-Smart Zone controller		CE54-24/F(C)	—
Debugging software		DE40-33/A(C)	—
Remote monitoring system	Software	FE30-24/DF(B)	—
	Controller	ME30-24/DF(B)	
Remote receiving LED panel		JS05	Applicable to the air duct-type indoor unit (Not suitable for GMV-ND80~140PLS/C-T)

NOTE:

If you need the above optional components, please consult your local sales company.



GREE ELECTRIC APPLIANCES, INC. OF ZHUHAI 519070

Add: West Jinji Rd, Qianshan Zhuhai, Guangdong, China

Tel: (+86-756)8522218

Fax: (+86-756)8669426

E-mail: gree@cn.gree.com www.gree.com

SJ00537917